

**SERIE 190 MULTISOCKET**



**Un'unica presa per 4 tipi di innesti** **IT**

E' un dato di fatto che sul mercato esistono vari profili di innesti ben distinti sia nella forma che nelle dimensioni e generalmente necessitano di essere assemblati con specifiche prese che di norma non sono intercambiabili fra di loro.

Per poter ovviare a questa incompatibilità AIGNEP propone alla sua clientela una soluzione pratica ed economica, un'unica presa da utilizzare con 4 differenti tipi di profili garantendo per tutti una perfetta tenuta.

**One socket for 4 different plugs** **GB**

It is a matter of fact that on the market are available various types of plugs well distinguished whether on the shape or on the dimensions, usually they need to be assembled with specific sockets which normally are not interchangeable.

To get round to this incompatibility AIGNEP is proud to offer to its customers a practical and cost-effective solution, a unique socket to be used with 4 different types of plugs, ensuring a perfect tightening.

**1 Kupplung Für 4 Typen Von Steckern** **DE**

Es ist eine Tatsache, dass die auf dem Markt verfügbaren Kupplungen und Stecker mit verschiedenen, nicht kompatiblen Profilen in Form und Grösse geliefert werden, d.h. sie können nicht untereinander ausgetauscht montiert werden.

Um diese Austauschbarkeit zu ermöglichen, bietet AIGNEP seinen Kunden eine praktische und kostengünstige Lösung an, wo mit einer Kupplung 4 verschiedene Profile (Stecker) verwendet werden können und dennoch eine perfekte Abdichtung gewährleistet ist.

**1 Corps pour 4 Embouts** **FR**

Le marché met à disposition des utilisateurs des différents types de coupleurs qui varient selon les normes, la forme et les dimensions. Souvent il est nécessaire d'assembler plusieurs types de coupleurs qui ne sont pas interchangeables.

Pour contourner cette incompatibilité AIGNEP est fière d'offrir à ses clients une solution pratique, fiable et rentable où un corps unique pour être utilisé avec 4 embouts différents.

**Un único enchufe para 4 tipos de adaptador** **ES**

Es un dato a remarcar que en el mercado existen varios tipos de adaptadores distintos, ya sea en la forma como en las dimensiones, que generalmente necesitan de enchufes específicos no intercambiables entre ellos.

Para solucionar este problema AIGNEP, propone una solución práctica y económica de intercambiabilidad con todos los adaptadores homologados en el mercado europeo, garantizando para todos una perfecta estanqueidad.

**Um único soquete p/ 4 tipos de plugs** **PT**

É um fato que no mercado existem vários perfis de plug bem diferentes entre si, seja no seu formato ou com relação às suas medidas e que, por isto normalmente não são intercambiáveis, necessitando de um soquete específico para cada diferente tipo de plug.

Para fugir desta incompatibilidade de tipos de modelos a AIGNEP propõe a seus clientes uma solução prática e econômica: um único soquete para ser utilizado com 4 diferentes tipos de perfis, garantindo para todos uma vedação perfeita.

**PROFIL SWISS**  
**SERIE 270**

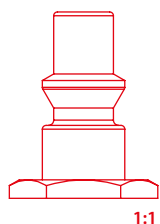

1:1

**DN**  
**5.5 mm**

Pag. 15.46

**PROFIL EUROPEAN**  
**SERIE 260**

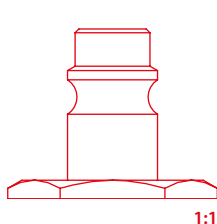

1:1

**DN**  
**7.5 - 7.8 mm**

Pag. 15.40

**PROFIL ITALIAN**  
**SERIE 250**

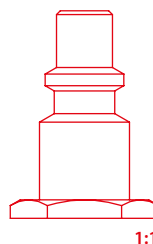

1:1

**DN**  
**5 mm**

Pag. 15.23

**PROFIL UNI ISO 6150 B-12**  
**SERIE 220**

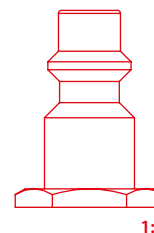

1:1

**DN**  
**5.5 mm**

Pag. 15.17



**CARATTERISTICHE TECNICHE**  
 TECHNICAL CHARACTERISTICS  
 TECHNISCHE ANGABEN  
 CARACTÉRISTIQUES TECHNIQUES  
 CARACTERÍSTICAS TÉCNICAS  
 CARACTERÍSTICAS TÉCNICAS



**Norma di Riferimento**  
 Reference standard  
 Entspricht der Norm  
 Norme de référence  
 Normativa de referencia  
 Norma de referència

1907/2006 <b>REACH</b> ✓	2011/65/CE ✓ <b>RoHS</b>
PED 2014/68/UE	SILICON FREE

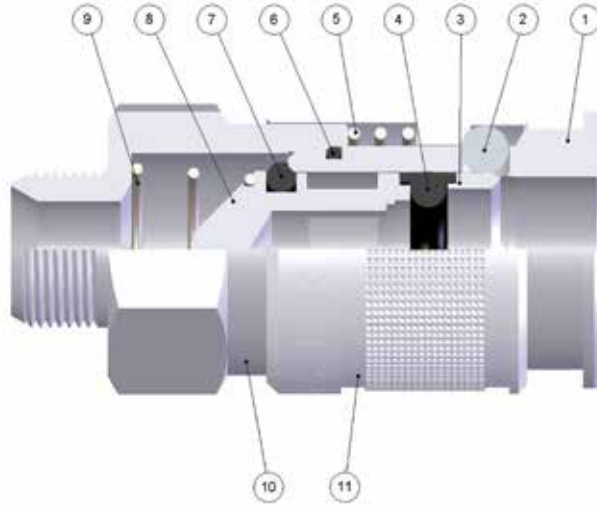

**FKM A RICHIESTA**  
 IF REQUESTED FKM  
 FKM AUF ANFRAGE  
 FKM SUR DEMANDE  
 FKM BAJO DEMANDA  
 FKM SOB ENCOMENDA

Materiali e Componenti	IT	Component Parts and Materials	GB	Komponenten und Materialien	DE
1 Corpo in Ottone Nichelato		1 Nickel-Plated Brass Body		1 Körper Messing Vernickelt	
2 Sfera in Acciaio AISI 420		2 Stainless Steel AISI 420 Balls		2 Kugel Edelstahl AISI 420	
3 Anello Guida Innesto in Ottone Nichelato		3 Nickel-Plated Brass Guide Ring Coupling		3 Ring Aus Messing	
4 Guarnizione O-Ring in NBR		4 NBR O-Ring Seals		4 O-Ring NBR	
5 Molla Ghiera in Acciaio AISI 302		5 Stainless Steel AISI 302 Ring Nut Spring		5 Entriegelungsfeder Edelstahl AISI 302	
6 Guarnizione O-Ring in NBR		6 NBR O-Ring Seals		6 O-Ring NBR	
7 Guarnizione O-Ring in NBR		7 NBR O-Ring Seals		7 O-Ring NBR	
8 Otturatore in Ottone Nichelato		8 Nickel-Plated Brass Shutter		8 Verschluss Messing Vernickelt	
9 Molla Otturatore in Acciaio AISI 302		9 Stainless Steel AISI 302 Shutter Spring		9 Verschlussfeder Edelstahl AISI 302	
10 Attacco Terminale in Ottone Nichelato		10 Nickel-Plated Brass Coupling Back Part		10 Einschraubkörper Messing Vernickelt	
11 Ghiera in Ottone Nichelato		11 Nickel-Plated Brass Sleeve		11 Entriegelungshülse Messing Vernickelt	

Matériaux et Composants	FR	Materialies y Componentes	ES	Materialis e Componentes	PT
1 Corps: Laiton Nickelé		1 Cuerpo en latón niquelado		1 Corpo em latão niquelado	
2 Bille: Acier Inoxydable AISI 420		2 Esfera en acero AISI 420		2 Esfera em aço AISI 420	
3 Bague en Laiton		3 Anillo guía enchufe en latón niquelado		3 Anel guia do plug em latão niquelado	
4 Joint Torique en NBR		4 Junta tórica en NBR		4 Vedação O-Ring em NBR	
5 Ressort de Bague: Acier Inoxydable AISI 302		5 Muelle tuerca en acero AISI 302		5 Mola de porca em aço AISI 302	
6 Joint Torique en NBR		6 Junta tórica en NBR		6 Vedação O-Ring em NBR	
7 Joint Torique en NBR		7 Junta tórica en NBR		7 Vedação O-Ring em NBR	
8 Clapet en Laiton Nickelé		8 Obturador en latón niquelado		8 Obturador em latão niquelado	
9 Ressort de Clapet: Acier Inoxydable AISI 302		9 Muelle obturador en acero AISI 302		9 Mola do obturador em aço AISI 302	
10 Corps: Laiton Nickelé		10 Conexión terminal en latón niquelado		10 Conexão terminal em latão niquelado	
11 Bague: Laiton Nickelé		11 Tuerca en latón niquelado		11 Porca em latão niquelado	



**Temperature**  
 Temperatures  
 Temperatur  
 Températures  
 Temperaturas  
 Temperaturas

**- 20 °C**  
**+ 80 °C**

Con O-ring in FKM  
 With FKM O-ring  
 Mit O-ring in FKM  
 Avec Joints en FKM  
 Con Junta tórica en FKM  
 Com O-ring em FKM

**- 10 °C**  
**+ 200 °C**



**Fluidi compatibili**  
 Aria compressa

**Fluids**  
 Compressed air

**Geeignete Medien**  
 Druckluft

**Fluides compatibles**  
 Air comprimé

**Fluidos compatibles**  
 Aire comprimido

**Fluidos compatíveis**  
 Ar comprimido

**Per altri fluidi, consultare l'ufficio tecnico Aignep.**  
 For other fluids, consult the technical department Aignep.  
 Für andere Flüssigkeiten, kontaktieren Sie uns.  
 Pour d'autres fluides, veuillez nous consulter.  
 Para otros fluidos póngase en contacto con el departamento técnico Aignep.  
 Para outros fluidos consulte o departamento técnico da Aignep.



### Pressione d'esercizio

Working Pressures

Betriebsdruck

Pression de service

Presión de Ejercicio

Pressão de Trabalho

**0 bar**

**16 bar**



### Max pressione statica (no pulsazioni)

Maximum static pressure (no pulsations)

Maximaler statischer Betriebsdruck (ohne pulsations)

Pression statique maximale (sans pulsation)

Presión estática máxima (sin pulsaciones)

Pressão estática máxima (sem pulsações)

**35 bar**



### Portata

NI/min

Flow Rate

Durchflusswerte

Débit

Caudal de Flujo

Vazão

Innesto Plug Stecker Embout Adaptador Plug	6 bar Δ 1	6 bar Δ 0.5	6 bar *
220	900	700	1450
250	800	700	1300
260 (7.5)	1350	1000	2150
260 (7.8)	1510	1200	2250
270	1100	750	1600

\* Scarico libero - Exhaust Free - Kostenlose Auspuff - Échappement libre - Escape Libre - Descarga livre.



### Filettatura

IT

### Threads

GB

### Gewindearten

DE

Gas cilindrica conforme ISO 228 Classe A.

Parallel gas in conformity with ISO 228 Class A.

Zylindrisches Gewinde nach Norm ISO 228 Classe A.

### Filetages

FR

### Roscas

ES

### Roscas

PT

Filetage cylindrique conforme: ISO 228 Class A.

Gas cilíndrica conforme ISO 228 Clase A.

Gas paralela conforme ISO 228 Classe A.

## 191

### PRESA MASCHIO

MALE SOCKET

VERSCHLUSS-KUPPLUNG MIT AUSSENGEWINDE

COUPLEUR MÂLE

ENCHUFE MACHO

SOQUETE COM ROSCA MACHO

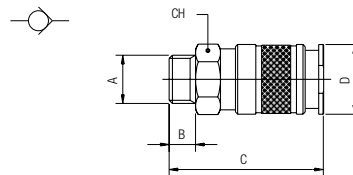

Code	A	B	C	D	CH	Pack.
00191 00 001	1/4	8	49	24	21	10
00191 00 002	3/8	9	50	24	21	10
00191 00 003	1/2	10	51	24	24	10

## 192

### PRESA FEMMINA

FEMALE SOCKET

VERSCHLUSS-KUPPLUNG MIT INNENGEWINDE

COUPLEUR FEMELLE

ENCHUFE HEMBRA

SOQUETE COM ROSCA FÊMEA

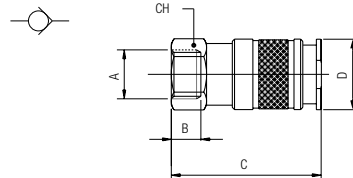

Code	A	B	C	D	CH	Pack.
00192 00 001	1/4	11	51	24	21	10
00192 00 002	3/8	11.5	51	24	21	10
00192 00 003	1/2	14	55	24	24	10

## 193

### PRESA A CALZAMENTO CON MOLLA

COMPRESSION SOCKET WITH SPRING  
 VERSCHLUSS-KUPPLUNG MIT KNICKSCHUTZFEDER  
 COUPLEUR AVEC RESSORT DE PROTECTION  
 ENCHUFE TUBO CON MUELLE  
 SOQUETE COM CONEXÃO PUSH-ON COM MOLA

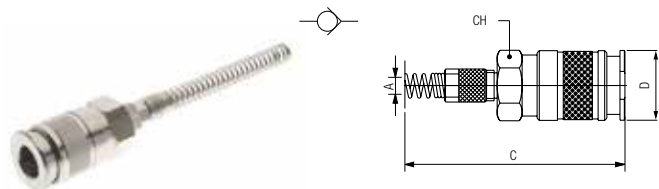

Code	A	C	D	CH	Pack.
00193 00 001	6/4	138	24	21	10
00193 00 002	8/6	144.5	24	21	10
00193 00 004	10/6.5	153.5	24	21	10
00193 00 003	10/8	153.5	24	21	10
00193 00 005	12/10	159	24	21	10

Molla Acciaio Inox AISI 304 - EN 1.4301  
 Stainless Steel Spring AISI 304 - EN 1.4301  
 Edelfeder AISI 304 - EN 1.4301  
 Ressort Acier Inoxydable AISI 304 - EN 1.4301  
 Muelle Acero Inoxidable AISI 304 - EN 1.4301  
 Mola Aço Inoxidável AISI 304 - EN 1.4301

## 194

### PRESA A CALZAMENTO

COMPRESSION SOCKET  
 VERSCHLUSS-KUPPLUNG MIT ÜBERWURFVERSCHRAUBUNG  
 COUPLEUR RACCORD À COIFFE  
 ENCHUFE TUBO  
 SOQUETE COM CONEXÃO PUSH-ON

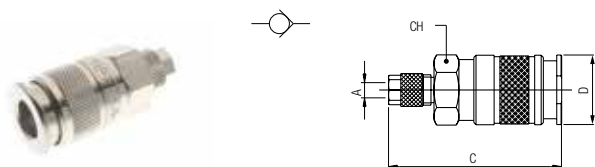

Code	A	C	D	CH	Pack.
00194 00 001	6/4	55	24	21	10
00194 00 002	8/6	55	24	21	10
00194 00 003	10/8	55	24	21	10
00194 00 007	12/10	57.5	24	21	10

## 195

### PRESA CON PORTAGOMMA A RESCA

SOCKET WITH REST FOR RUBBER HOSE  
 VERSCHLUSS-KUPPLUNG MIT SCHLAUCHTÜLLE  
 COUPLEUR À DOUILLE ANNELÉE POUR TUBE  
 ENCHUFE ESPIGA  
 SOQUETE COM ESPIGÃO PARA MANGUEIRA DE BORRACHA

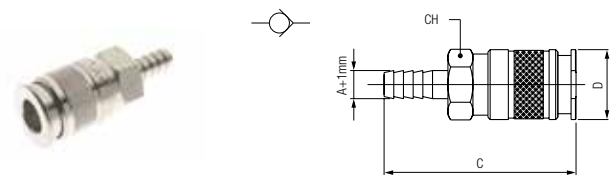

Code	A	C	D	CH	Pack.
00195 00 001	6	61	24	21	10
00195 00 002	8	61	24	21	10
00195 00 003	10	61	24	21	10
00195 00 004	12	61	24	21	10

## 196

### PRESA CON PORTAGOMMA

SOCKET FOR RUBBER HOSE  
 VERSCHLUSS-KUPPLUNG FÜR GUMMISCHLAUCH  
 COUPLEUR À DOUILLE ANNELÉE POUR TUBE  
 ENCHUFE COM PORTAGOMA  
 SOQUETE COM ESPIGÃO PARA TUBO DE BORRACHA

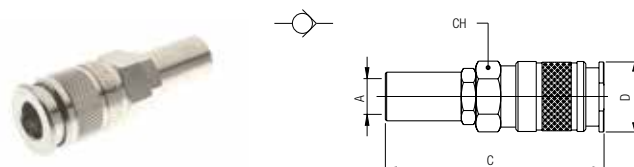

Code	A	C	D	CH	Pack.
00196 00 001	14/6	71	24	21	10
00196 00 002	17/8	71	24	21	10
00196 00 003	19/10	71	24	21	10