

**RACCORDI A COMPRESSIONE, RACCORDI A BICONO E RACCORDI UNIVERSALI**

*COMPRESSION FITTINGS, DOUBLE CONE FITTINGS AND UNIVERSAL FITTINGS*

*KLEMMRING VERSCHRAUBUNGEN, DOPPELKEGEL VERSCHRAUBUNGEN, UNIVERSAL VERSCHRAUBUNGEN*

*RACCORDS À COMPRESSION, RACCORDS À BICONE, RACCORDS UNIVERSELS LAITON*

*RACORDAJE A COMPRESIÓN, RACORDAJE UNIVERSAL A BICONO, RACORDAJE UNIVERSAL*

*CONEXÕES DE COMPRESSÃO, CONEXÕES UNIVERSAIS DE CONE DUPLO, CONEXÕES UNIVERSAIS*



**Serie Compression Fittings**

## Serie 9000



## Serie 10000



## Serie 13000



9000  
10000  
13000

**RACCORDI UNIVERSALI A BICONO***UNIVERSAL DOUBLE CONE FITTINGS**DOPPELKEGEL VERSCHRAUBUNGEN**RACCORDS UNIVERSELS A DOUBLE CONE**RACORDAJE UNIVERSAL A BICONO**CONEXÕES UNIVERSAIS DE CONE DUPLO*



**CARATTERISTICHE TECNICHE**  
 TECHNICAL CHARACTERISTICS  
 TECHNISCHE ANGABEN  
 CARACTÉRISTIQUES TECHNIQUES  
 CARACTERÍSTICAS TÉCNICAS  
 CARACTERÍSTICAS TÉCNICAS



**Norma di Riferimento**  
 Reference standard  
 Entspricht der Norm  
 Norme de référence  
 Normativa de referencia  
 Norma de referência

1907/2006

REACH ✓

2011/65/CE

RoHS ✓

PED

2014/68/UE

SILICON

FREE

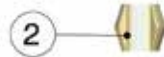

Sede e bicono a norma DIN 3862.  
 Seat and olive in conformity with  
 DIN Standards 3862.  
 Ein Registriert unter DIN 3862 Bicone.  
 Un enregistré en application DIN 3862 bicone.  
 Sede y bicono a norma DIN 3861.  
 Sede e bucha conforme Norma DIN 3862.



Rinforzo Art. 10770.  
 Internal support bush Art. 10770.  
 Verstärkung Art. 10770.  
 Renforcement Art. 10770.  
 Refuerzo Art. 10770.  
 Bucha de reforço interno Cód. 10770.

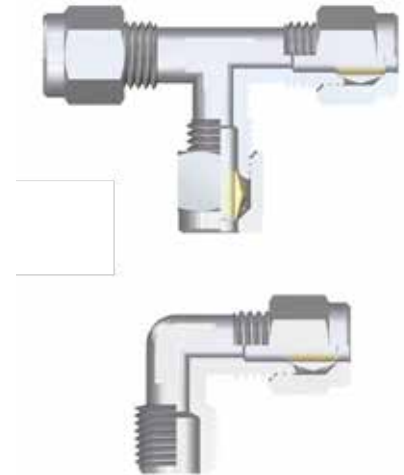

Materiali e Componenti	IT	Component Parts and Materials	GB	Komponenten und Materialien	DE
1 Dado in Ottone Nichelato		1 Nickel-plated Brass Nut		1 Überwurfmutter Messing vernickelt	
2 Ogiva in Ottone (PTFE a richiesta)		2 Brass Olive (If requested PTFE)		2 Klemmring Messing (PTFE auf Anfrage)	
3 Corpo in Ottone Nichelato		3 Nickel-plated Brass Body		3 Körper Messing vernickelt	
4 Bussolina di rinforzo		4 Internal support bush		4 Stützhülse Messing	

Matériaux et Composants	FR	Materiales y Componentes	ES	Materiais e Componentes	PT
1 Ecrou: laiton nickelé		1 Tuerca en Latón Niquelado		1 Porca em Latão niquelado	
2 Ague: laiton (sur demande en PTFE)		2 Bicono en Latón (PTFE a demanda)		2 Bucha em Latão (PTFE sob encomenda)	
3 Corps: laiton nickelé		3 Cuerpo en Latón Niquelado		3 Corpo em Latão niquelado	
4 Fourrure intérieure: laiton		4 Refuerzo		4 Bucha de reforço interna	



Tubi di Collegamento	IT	Connection Tubes	GB	Geeignete Rohre	DE
Tubi in rame, ferro, acciaio, alluminio, ottone, ecc. Con apposito rinforzo interno (art. 10770), possono essere utilizzati anche tubi in PA11, PA6, ecc.		Tubes made in copper, steel, iron, aluminium, brass, etc. With an inside support bush (art. 10770), can be used also for plastic material such as PA11, PA6, etc.		Rohre in Kupfer, Eisen, Stahl, Aluminium, Messing, usw. Mit einer internen Stützhülse (Art. 10770), können auch Rohre aus PA11, PA6, usw. verwendet werden.	

Tubes Conseillés	FR	Tubos de Conexión	ES	Tubos de Conexão	PT
Tubes en cuivre, acier, aluminium, laiton, etc. Avec une fourrure intérieure (art. 10770), les tubes plastiques PA11, PA6, etc. peuvent être utilisés.		Tubos en cobre, hierro, acero, aluminio, latón, etc. Con el correspondiente refuerzo interno (art. 10770), pueden utilizarse también con tubo en PA11, PA6, etc.		Tubos de cobre, ferro, aço, alumínio, latão, etc. Com bucha de reforço interna (cód. 10770), podem ser utilizados também com tubos em PA11, PA6, etc.	



Filettatura	IT	Threads	GB	Gewindearten	DE
Gas conica conforme ISO 7.1, BS 21, DIN 2999. Gas cilindrica conforme ISO 228 Classe A. Metrica conforme ISO R/262.		Tapered gas in conformity with ISO7.1, BS 21, DIN 2999. Parallel gas in conformity with ISO 228 Class A. Metric in conformity with ISO R/262.		Konisches Gewinde nach Norm ISO 7.1, BS 21, DIN 2999. Zylindrisches Gewinde nach Norm ISO 228 Classe A. Metrisches Gewinde nach Norm ISO R/262.	

Filetages	FR	Roscas	ES	Roscas	PT
Filetage conique conforme: ISO7.1, BS 21, DIN 2999. Filetage cylindrique conforme: ISO 228 Classe A. Filetage métrique conforme: ISO R/262.		Gas cónica conforme ISO 7.1, BS 21, DIN 2999. Gas cilíndrica conforme ISO 228 Clase A. Métrica conforme ISO R/262.		Gas cônica conforme ISO 7.1, BS 21, DIN 2999. Gas paralela conforme ISO 228 Classe A. Métrica conforme ISO R/262.	



## Pressioni e Temperature

IT

Pressioni e temperature vengono determinate dal tipo di tubo impiegato, pertanto tali valori sono da definirsi in base alle caratteristiche del tubo stesso.

Riportiamo di seguito i valori delle pressioni massime consigliate per l'utilizzo dei raccordi con tubi di rame dallo spessore di 1 mm a 20° C.

I valori delle pressioni consigliate, riportate in tabella, sono stati ottenuti dai valori di prova adottando un Coefficiente di Sicurezza 4.

Sono disponibili i certificati delle prove rilasciati dai vari laboratori che le hanno eseguite.

## Pressures and Temperatures

GB

The working pressures and working temperatures depend on which type of tube is used, for this reason, the values must be determined in accordance with the tube's features.

Hereunder, we specify the values of the maximum pressure advised for the fittings at a temperature of 20° C connected with copper tube, which has a thickness of 1 mm.

The values of working pressures advised, specified in table have been obtained from the test values using a Safety Factor 4.

It is available the test report made by the external laboratory test.

## Druckbereich und Temperatur

DE

Drücke und Temperaturen sind definiert durch die verwendete Ausführung der Leitung, d.h. die Werte der eingesetzten Rohre sind zu beachten.

Nachfolgend geben wir die Werte des maximalen Druckes für den Einsatz der Verschraubungen mit Kupferrohren an, deren Wandstärke min. 1mm beträgt und bei einer Temperatur von 20° C.

Es muss berücksichtigt werden, dass die angegebenen Druckwerte in der Tabelle mit einem Sicherheitsfaktors von 4 berechnet wurden.

Es stehen Prüfberichte zur Verfügung, die von verschiedenen, externen Labors gemacht wurden.

## Pressions et Températures

FR

Les pressions et températures de service dépendent du type de tube utilisé. Pour cette raison, les valeurs doivent être déterminées en conformité avec les caractéristiques du tube. Ci-dessous, nous indiquons les valeurs de la pression maximale recommandée pour une connexion avec un tube en cuivre de 1 mm d'épaisseur à une température de 20° C.

Les pressions de service indiquées ont été calculées avec un coefficient de sécurité de 4.

Des rapports externes de tests sont disponibles sur demande pour attester ces valeurs.

## Presiones y Temperaturas

ES

Presión y temperatura vienen determinadas según el tipo de tubo empleado, por lo tanto estos valores se definen en base a las características del mismo tubo. Representamos a continuación los valores de las presiones máximas aconsejadas para la utilización de los racores con tubo de cobre espesor 1 mm a 20° C.

Los valores de las presiones aconsejadas, representadas en la tabla, han sido obtenidas de valores de prueba adoptando un coeficiente de seguridad 4.

Están disponibles los certificados de las pruebas realizadas en distintos laboratorios especializados.

## Pressões e Temperaturas

PT

Pressões e temperaturas dependem do tipo de tubo aplicado, portanto tais valores devem ser definidos com base nas características do tubo em questão.

A seguir apresentamos os valores das pressões máximas aconselhadas para a utilização das conexões com tubos de cobre de espessura de 1 mm a 20° C.

Os valores das pressões aconselhadas, reportados na tabela, foram obtidas dos valores de teste adotando-se um Coeficiente de Segurança 4.

Os certificados de teste executados por laboratórios externos estão disponíveis.



## Temperature

Temperatures

Temperatur

Températures

Temperaturas

Temperaturas

- 60 °C  
+ 300 °C

Misura Size Größe Dimensions Tamaño Tamanho	Pressione massima consigliata - 20 °C Maximum pressure advised - 20 °C Maximal empfohlener Druck - 20 °C Pression maximum conseillée - 20 °C Presión máxima aconsejada - 20 °C Pressão máxima aconselhada - 20 °C	
	Ø	kg/cm <sup>2</sup>
4	150	148.4
6	150	148.4
8	130	128.6
10	180	178.1
12	150	148.4
14	115	113.3
15	75	74.2
16	75	74.2
18	60	59.4
22	40	39.6



## Fluidi compatibili

Acqua / Olio / Aria compressa

Fluidi in genere per l'impiantistica idraulica, oleodinamica, idropneumatica, ecc.

### Fluids

Water / Oils / Compressed air

Fluids in general for the hydraulic, pneumatic and oildynamic plants etc.

### Geeignete Medien

Wasser / Öl / Druckluft

Medien im Allgemeinen für hydraulische-, hydropneumatische- und pneumatische Anlagen, usw.

### Fluides compatibles

Eau / Huile / Air comprimé

Fluides courants utilisés en hydraulique et pneumatique, etc.

### Fluidos compatibles

Agua / Aceite / Aire comprimido

Fluidos en general para los campos hidráulicos, neumáticos y oleodinámicos, etc.

### Fluidos compatíveis

Água / Óleo / Ar comprimido

Fluidos em geral para aplicações hidráulicas, oleodinâmicas, hidropneumáticas, etc.



## Coppia di serraggio

Torque specifications

Angaben Drehmoment

Couple de serrage

Par de apriete

Especificações de Torque

Ø	COPPIE DI SERRAGGIO DADO SU OGIVA TORQUE FORCE ON OLIVE NUT ANZUGSDREHMOMENT ZWISCHEN MUTTER UND KLEMMRING COUPLE DE SERRAGE DE L'ÉCROU SUR LA BAGUE OLIVE PAR DE APRIETE DE LA TUERCA DE OJIVA TORQUE DE APERTO PARA PORCA EM BUCHA		
	N° Giri chiave N° Key turns N° Schlüssel Umdrehungen N° de tours N° Giro de la tuerca N° Rotação da porca	Forza Force Drehmoment Couple Fuerza Força	Forza Force Drehmoment Couple Fuerza Força
mm	Nm	kgf	
4	1 1/4 + 1/4	15	1.55
6	1 1/4 + 1/4	18	1.85
8	1 1/4 + 1/4	22	2.25
10	1 1/4 + 1/4	40	4
12	1 1/4 + 1/4	50	5
14	1 1/4 + 1/4	70	7.1
15	1 + 1/4	90	9.1
16	1 + 1/4	90	9.1
18	1 + 1/4	130	13.25
22	1 + 1/4	130	13.25

Forze di serraggio, minime consigliate, e n° di giri utili, per garantire un montaggio corretto.  
Torque force, minimum recommended, and useful turn, to ensure a correct installation.  
Empfohlenes anzugsdrehmoment und mindest umdrehungsanzahl für eine korrekte montage.  
Couple de serrage minimum recommandé et nombre de tours pour assurer une installation correcte.  
Par de apriete mínimo recomendado y n. giros necesarios para garantizar un montaje correcto.  
Torque de aperto mínimo garantido, n. rotações necessário para garantir a correcta instalação.

## 10200

### RACCORDO A T INTERMEDIO

TEE CONNECTOR

T-ANSCHLUSS

RACCORD TÉ

RACOR A T INTERMEDIO

CONEXÃO EM "T" TUBO-TUBO

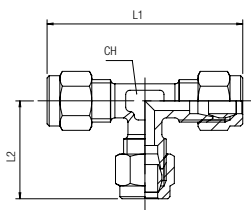

Code	Tube	L1	L2	CH	Pack.
10200 00 001	4	41	20.5	8	10
10200 00 002	6	46	23	9	10
10200 00 003	8	53	26.5	12	10
10200 00 004	10	62	31	13	10
10200 00 005	12	67	33.5	14	10
10200 00 006	14	72	36	18	10
10200 00 007	15	78	39	18	10
10200 00 008	16	78	39	17	10
10200 00 009	18	83	41.5	20	10
10200 00 010	22	86	43	27	10

## 10220

### RACCORDO A T MASCHIO CENTRALE

TEE MALE ADAPTOR CENTRE LEG

T-EINSCHRAUBVERSCHRAUBUNG KONISCH

TÉ À PIQUAGE MÂLE CENTRAL, CONIQUE

RACOR A T MACHO CENTRAL

CONEXÃO EM "T" COM ROSCA MACHO CENTRAL

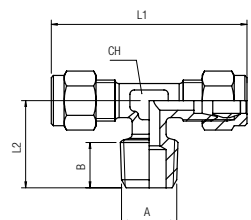

Code	Tube	A	L1	L2	CH	Pack.
10220 00 001	4	1/8	41	15	8	10
10220 00 002	6	1/8	46	16.5	9	10
10220 00 003	6	1/4	46	20.5	9	10
10220 00 004	8	1/8	53	16.5	12	10
10220 00 005	8	1/4	53	20.5	12	10
10220 00 006	8	3/8	57	23	13	10
10220 00 007	10	1/4	62	22.5	13	10
10220 00 008	10	3/8	62	23.5	13	10
10220 00 009	10	1/2	64	27	14	10
10220 00 010	12	1/4	66	24.5	14	10
10220 00 011	12	3/8	66	25	14	10
10220 00 012	12	1/2	67	26.5	14	10
10220 00 013	14	3/8	75	26	16	10
10220 00 014	14	1/2	78	31	18	10
10220 00 015	15	1/2	80	31	18	10
10220 00 016	16	1/2	79	29	17	10
10220 00 017	18	1/2	84	29.5	20	10
10220 00 018	18	3/4	82	32.5	20	10
10220 00 019	22	3/4	86	34	27	10

## 10230

### RACCORDO A T MASCHIO LATERALE

TEE MALE ADAPTOR OFF SET LEG

L-EINSCHRAUBVERSCHRAUBUNG KONISCH

TÉ À PIQUAGE LATÉRAL, CONIQUE

RACOR A T MACHO LATERAL

CONEXÃO EM "T" COM ROSCA MACHO LATERAL

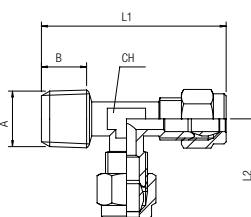

Code	Tube	A	L1	L2	CH	Pack.
10230 00 001	4	1/8	35	21	8	10
10230 00 002	6	1/8	39	24	9	10
10230 00 003	6	1/4	43	23	9	10
10230 00 004	8	1/8	43	26	12	10
10230 00 005	8	1/4	46	26	12	10
10230 00 006	8	3/8	49	26	13	10
10230 00 007	10	1/4	55	31	13	10
10230 00 008	10	3/8	54	31	13	10
10230 00 009	12	3/8	58	33	14	10
10230 00 010	12	1/2	59	34	15	10
10230 00 011	14	1/2	67	39	18	10

## 10240

### RACCORDO A T FEMMINA CENTRALE

TEE FEMALE CENTRE LEG

T-EINSCHRAUBVERSCHRAUBUNG INNENGEWINDE

TÉ FEMELLE CENTRAL

RACOR A T HEMBRA CENTRAL

CONEXÃO EM "T" COM ROSCA FÊMEA CENTRAL

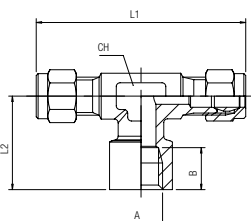

Code	Tube	A	B	L1	L2	CH	Pack.
10240 00 001	4	1/8	8.5	42	18	8	10
10240 00 002	6	1/8	8.5	46.5	19.5	9	10
10240 00 003	6	1/4	11	54	24.5	13	10
10240 00 004	8	1/8	8.5	53	19.5	12	10
10240 00 005	8	1/4	11	55	24.5	13	10
10240 00 007	10	1/4	11	63	24.5	13	10
10240 00 008	10	3/8	10.5	65	26	14	10
10240 00 009	10	1/2	10.5	66	26	15	10
10240 00 010	12	1/4	11	66	25.5	14	10
10240 00 011	12	3/8	10.5	66	26	14	10
10240 00 012	12	1/2	10.5	66	26	15	10
10240 00 013	14	1/2	10.5	67	30	18	10
10240 00 014	15	1/2	10.5	77	30	18	10
10240 00 015	16	1/2	10.5	77	28.5	17	10
10240 00 016	18	1/2	10.5	84	28	20	10
10240 00 017	18	3/4	14	83	34	20	10

## 10260

### RACCORDO A L INTERMEDIO

ELBOW CONNECTOR  
WINKELVERSCHRAUBUNG  
RACCORD EQUERRE  
RACOR A L INTERMEDIO  
CONEXÃO EM "L" TUBO-TUBO

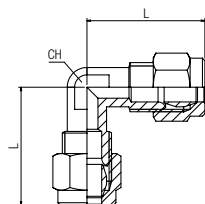

Code	Tube	L	CH	Pack.
10260 00 001	4	20	8	10
10260 00 002	6	24	9	10
10260 00 003	8	28	11	10
10260 00 004	10	32	13	10
10260 00 005	12	34	14	10
10260 00 006	14	36.5	17	10
10260 00 007	15	38	17	10
10260 00 008	16	39	17	10
10260 00 009	18	41.5	20	10
10260 00 010	22	43	27	10

## 10280

### RACCORDO A L MASCHIO

ELBOW MALE ADAPTOR  
WINKELVERSCHRAUBUNG KONISCH  
EQUERRE MÂLE, CONIQUE  
RACOR A L MACHO  
CONEXÃO EM "L" COM ROSCA MACHO

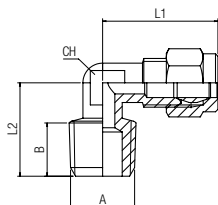

Code	Tube	A	L1	L2	CH	Pack.
10280 00 001	4	1/8	20.5	15	8	10
10280 00 002	6	1/8	23.5	17	9	10
10280 00 003	6	1/4	23.5	19	9	10
10280 00 004	8	1/8	28	18	11	10
10280 00 005	8	1/4	28	21.5	11	10
10280 00 006	8	3/8	28.5	24	13	10
10280 00 007	10	1/4	32	23.5	13	10
10280 00 008	10	3/8	32	24.5	13	10
10280 00 009	10	1/2	34	25	14	10
10280 00 010	12	1/4	34	24	14	10
10280 00 011	12	3/8	34	26	14	10
10280 00 012	12	1/2	34	25	14	10
10280 00 013	14	3/8	38	26	17	10
10280 00 014	14	1/2	38	28.5	17	10
10280 00 015	15	1/2	39	28.5	17	10
10280 00 016	16	1/2	40	28	17	10
10280 00 017	18	1/2	42	29.5	20	10
10280 00 018	18	3/4	42	32	20	10
10280 00 019	22	3/4	42.5	34	27	10

## 10290

### RACCORDO A L FEMMINA

ELBOW FEMALE ADAPTOR  
WINKELVERSCHRAUBUNG INNENGEWINDE  
EQUERRE FEMELLE  
RACOR A L HEMBRA  
CONEXÃO EM "L" COM ROSCA FÊMEA

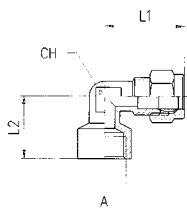

Code	Tube	A	B	L1	L2	CH	Pack.
10290 00 001	4	1/8	8.5	22	18	8	10
10290 00 002	6	1/8	8.5	23.5	18	9	10
10290 00 003	6	1/4	10.5	24	22.5	11	10
10290 00 004	8	1/8	8.5	28	21	11	10
10290 00 005	8	1/4	11	28.5	25.5	13	10
10290 00 006	8	3/8	10.5	29	25	14	10
10290 00 007	10	1/4	11	34	25	13	10
10290 00 008	10	3/8	10.5	33	25	14	10
10290 00 009	10	1/2	10.5	33	27	15	10
10290 00 010	12	1/4	11	34	26	14	10
10290 00 011	12	3/8	10.5	34	26	14	10
10290 00 012	12	1/2	10.5	33	27	15	10
10290 00 013	14	1/2	10.5	38.5	30	18	10
10290 00 014	15	1/2	10.5	39	30	18	10
10290 00 015	16	1/2	10.5	40	30	18	10
10290 00 016	18	1/2	10.5	42	29	20	10
10290 00 017	18	3/4	14	42	33.5	20	10

## 10460

### RACCORDO DIRITTO INTERMEDIO

STRAIGHT CONNECTOR  
VERBINDUNGSVERSCHRAUBUNG  
RACCORD UNION DOUBLE  
RACOR RECTO INTERMEDIO  
CONEXÃO RETA TUBO-TUBO

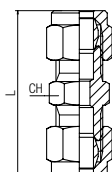

Code	Tube	L	CH	Pack.
10460 00 001	4	30.5	10	10
10460 00 002	6	35	11	10
10460 00 003	8	36	13	10
10460 00 004	10	43.5	16	10
10460 00 005	12	44	18	10
10460 00 006	14	47	21	10
10460 00 007	15	52	21	10
10460 00 008	16	52.5	22	10
10460 00 009	18	56.5	26	10
10460 00 010	22	55	30	10

## 10465

### RACCORDO DRITTO INTERMEDIO DI ATTRAVERSAMENTO

STRAIGHT BULKHEAD CONNECTOR  
 SCHOTTVERSCHRAUBUNG  
 RACCORD DROIT TRAVERSÉE DE CLOISON  
 RACOR RECTO INTERMEDIO PASATABIQUES  
 CONEXÃO RETA PASSAMURO TUBO-TUBO

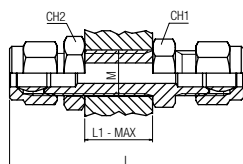

Code	Tube	L	L1 max	CH1	CH2	M	Pack.
10465 00 001	4	46.5	15	10	13	M8x1	10
10465 00 002	6	51.5	15	14	14	M10x1	10
10465 00 003	8	53	15	14	17	M12x1	10
10465 00 004	10	61.5	16	19	21	M16x1,5	10
10465 00 005	12	67.5	20	22	24	M18x1,5	10
10465 00 006	14	72	20	24	24	M20x1,5	10

## 10480

### RACCORDO DIRITTO MASCHIO CONICO

STRAIGHT MALE ADAPTOR (TAPER)  
 GERADE EINSCHRAUBVERSCHRAUBUNG KONISCH  
 RACCORD DROIT MÂLE CONIQUE  
 RACOR RECTO MACHO  
 CONEXÃO RETA COM ROSCA MACHO

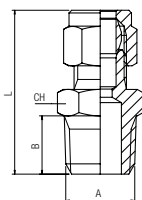

Code	Tube	A	L	CH	Pack.
10480 00 001	4	1/8	25.5	11	10
10480 00 002	4	1/4	28.5	14	10
10480 00 003	6	1/8	27.5	11	10
10480 00 004	6	1/4	31	14	10
10480 00 005	6	3/8	31.5	17	10
10480 00 006	8	1/8	28	13	10
10480 00 007	8	1/4	31.5	14	10
10480 00 008	8	3/8	32	17	10
10480 00 009	10	1/4	35	16	10
10480 00 010	10	3/8	35.5	17	10
10480 00 011	10	1/2	37	21	10
10480 00 012	12	1/4	36	18	10
10480 00 013	12	3/8	37	18	10
10480 00 014	12	1/2	37	21	10
10480 00 015	14	3/8	37	20	10
10480 00 016	14	1/2	39.5	21	10
10480 00 017	15	1/2	40	21	10
10480 00 018	16	1/2	42.5	22	10
10480 00 019	16	3/4	44	27	10
10480 00 020	18	1/2	44	24	10
10480 00 021	18	3/4	45.5	27	10
10480 00 022	22	1/2	44	30	10
10480 00 023	22	3/4	45.5	30	10

## 10485

### RACCORDO DIRITTO MASCHIO CILINDRICO

STRAIGHT MALE ADAPTOR (PARALLEL)  
 GERADE EINSCHRAUBVERSCHRAUBUNG ZYLINDRISCH  
 RACCORD DROIT MÂLE CYLINDRIQUE  
 RACOR RECTO MACHO CILÍNDRICO  
 CONEXÃO RETA COM ROSCA MACHO PARALELA

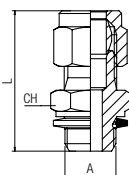

Code	Tube	A	L	CH	Pack.
10485 00 001	4	1/8	25	13	10
10485 00 002	6	1/8	26.5	13	10
10485 00 003	6	1/4	30	17	10
10485 00 004	8	1/8	28.5	13	10
10485 00 005	8	1/4	31	17	10
10485 00 006	8	3/8	34.5	22	10
10485 00 007	10	1/4	34.5	17	10
10485 00 008	10	3/8	38	22	10
10485 00 009	14	3/8	39.5	22	10
10485 00 010	14	1/2	42	27	10
10485 00 011	22	3/4	47	32	10
10485 00 012	22	1"	50	40	10



Temperature

<b>min</b>	<b>max</b>
- 20 °C	+ 80 °C



## 10500

### RACCORDO DIRITTO FEMMINA

STRAIGHT FEMALE ADAPTOR  
 AUFSCRAUBVERSCHRAUBUNG  
 RACCORD DROIT TARAUEE  
 RACOR RECTO HEMBRA  
 CONEXÃO RETA COM ROSCA FÊMEA

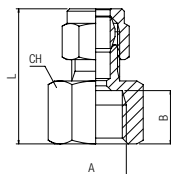

Code	Tube	A	B	L	CH	Pack.
10500 00 001	4	1/8	8.5	24	14	10
10500 00 002	4	1/4	11	26.5	17	10
10500 00 003	6	1/8	8.5	25.5	14	10
10500 00 004	6	1/4	11	28	17	10
10500 00 005	8	1/8	8.5	26	14	10
10500 00 006	8	1/4	11	28.5	17	10
10500 00 007	8	3/8	11.5	29.5	20	10
10500 00 008	10	1/4	11	32	17	10
10500 00 009	10	3/8	11.5	32.5	20	10
10500 00 010	10	1/2	13.5	34.5	24	10
10500 00 011	12	1/4	14.5	32	18	10
10500 00 012	12	3/8	11.5	32.5	20	10
10500 00 013	12	1/2	13.5	34.5	24	10
10500 00 014	14	3/8	11.5	34	20	10
10500 00 015	14	1/2	13.5	36.5	24	10
10500 00 016	15	1/2	13.5	36.5	24	10
10500 00 017	16	1/2	13.5	39	24	10
10500 00 018	16	3/4	14.5	40.5	30	10
10500 00 019	18	1/2	13.5	40	24	10
10500 00 020	18	3/4	14.5	41	30	10
10500 00 021	22	3/4	14.5	40	30	10

## 10510

### RACCORDO A CROCE

EQUAL CROSS  
 KREUZVERSCHRAUBUNG  
 RACCORD EN CROIX  
 RACOR A CRUZ  
 CONEXÃO TIPO CRUZETA TUBO-TUBO

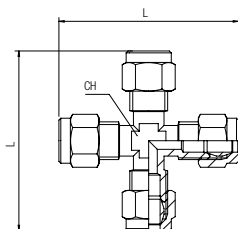

Code	Tube	L	CH	Pack.
10510 00 001	4	45	8	10
10510 00 002	6	47	9	10
10510 00 003	8	54	11	10
10510 00 004	10	64	13	10
10510 00 005	12	70	17	10
10510 00 006	14	74.5	17	10

## 13530

### ADATTATORE ORIENTABILE MASCHIO CILINDRICO

ORIENTING MALE ADAPTOR PARALLEL  
 EINSCHRAUBSTECKVERSCHRAUBUNG ZYLINDRISCH  
 ADAPTATEUR D'ORIENTATION CYLINDRIQUE  
 ADAPTADOR ORIENTABLE MACHO CILÍNDRICO  
 ADAPTADOR ORIENTÁVEL COM ROSCA MACHO PARALELA

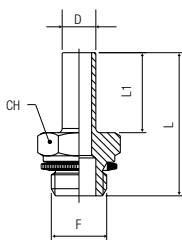

Code	D	F	L	L1	CH	Pack.
13530 00 001	6	1/8	27.5	16	13	10
13530 00 002	6	1/4	31	16	17	10
13530 00 003	8	1/8	31.5	19	13	10
13530 00 004	8	1/4	34	19	17	10
13530 00 005	8	3/8	38	19	22	10
13530 00 006	10	1/4	35	20	17	10
13530 00 007	10	3/8	39	20	22	10
13530 00 008	14	3/8	40	21	22	10
13530 00 009	14	1/2	42	21	27	10



Temperature

<b>min</b>	<b>max</b>
- 20 °C	+ 80 °C

## 13540

### MANICOTTO PORTAGOMMA PER TUBO CAUCCIÙ

SLEEVE HOSE ADAPTER FOR CAOUTCHOUC TUBES  
 SCHLAUCHTÜLLE FÜR GUMMISCHLAUCH  
 DOUILLE ANNELÉE POUR TUBE CAOUTCHOUC  
 MANGUITO PORTAGOMA PARA TUBO DE CAUCHO  
 ESPIGÃO PARA ENGATE DE MANGUEIRAS

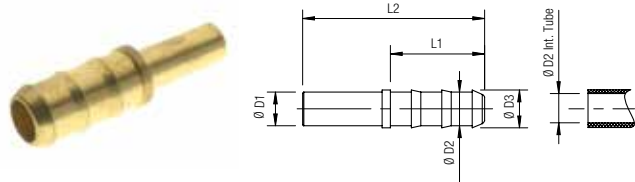

Code	D1	D2	D3	L1	L	Pack.
13540 00 01 GG 00	6	7	9	22.5	40.5	10
13540 00 01 GH 00	8	7	9	22.5	43.5	10
13540 00 01 GP 00	8	10	12	22.5	43.5	10
13540 00 01 GI 00	10	7	9	22.5	44.5	10
13540 00 01 FR 00	10	10	12	22.5	44.5	10
13540 00 01 FS 00	12	10	12	22.5	45	10
13540 00 01 GM 00	12	13	15.5	29.5	52	10
13540 00 01 GN 00	14	13	15.5	29.5	52.5	10

## 10550

### RACCORDO ORIENTABILE A L CON VITE

SINGLE BANJO BODY WITH STEM  
 WINKELSCHWENKVERSCHRÄUBUNG (DREHBAR)  
 EQUERRE MÂLE BANJO, ORIENTABLE  
 RACOR ORIENTABLE A L CON TORNILLO  
 CONEXÃO EM "L" ORIENTÁVEL TIPO BANJO

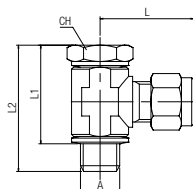

Code	Tube	A	L	L2	L1	CH	Pack.
10550 00 001	4	1/8	21.5	31	23	14	10
10550 00 002	6	1/8	23	31	23	14	10
10550 00 003	6	1/4	26	32	23.5	17	10
10550 00 004	8	1/8	26.5	31	23	14	10
10550 00 005	8	1/4	27	32	23.5	17	10
10550 00 006	8	3/8	28	36	26.5	19	10
10550 00 007	10	1/4	31.5	32	23.5	17	10
10550 00 008	10	3/8	32.5	36	26.5	19	10
10550 00 009	14	1/4	36.5	44	36.5	17	10
10550 00 010	14	3/8	36.5	46	37	22	10
10550 00 011	14	1/2	36.5	49	38	24	10
10550 00 012	22	3/4	45.5	64	52	32	10

	min	max
Temperature	- 20 °C	+ 80 °C

## 10680

### DADO

NUT  
 ÜBERWURFMUTTER  
 ECROU  
 TUERCA  
 PORCA

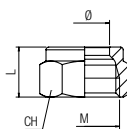

Code	Tube	L	CH	M	Pack.
10680 00 01 X1 NB	4	9.5	10	M 8x1	50
10680 00 01 X4 NB	6	10.5	12	M 10x1	50
10680 00 01 X7 NB	8	11.5	14	M 12x1	50
10680 00 01 X9 NB	10	13.5	19	M 16x1.5	50
10680 00 01 Y1 NB	12	13.5	21	M 18x1.5	50
10680 00 01 Y3 NB	14	14.5	23	M 20x1.5	20
10680 00 01 Y4 NB	15	16	23	M 20x1.5	20
10680 00 01 Y5 NB	16	17	25	M 22x1.5	20
10680 00 01 Y7 NB	18	18	28	M 24x1.5	20
10680 00 01 J1 NB	22	18	34	M 30x1.5	10

## 10740

### OGIVA OTTONE

BRASS OLIVE  
 KLEMMRING MESSING  
 OLIVE LAITON  
 BICONO LATÓN  
 BUCHA DE LATÃO

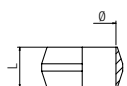

Code	Tube	L	Pack.
10740 00 02 X1 00	4	5.5	50
10740 00 02 X4 00	6	6.5	50
10740 00 02 X7 00	8	6.5	50
10740 00 02 X9 00	10	7.5	50
10740 00 02 Y1 00	12	8	50
10740 00 02 Y3 00	14	8.5	20
10740 00 02 Y4 00	15	9	20
10740 00 02 Y5 00	16	9.5	20
10740 00 02 Y7 00	18	10	20
10740 00 02 J1 00	22	10	10

## 10760

### OGIVA PTFE

PTFE OLIVE  
KLEMMRING PTFE  
OLIVE PTFE  
BICONO PTFE  
BUCHA EM PTFE

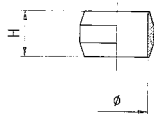

Code	Tube	H	Pack.
10760 00 28 X1 00	4	5.5	50
10760 00 28 X4 00	6	6.5	50
10760 00 28 X7 00	8	6.5	50
10760 00 28 X9 00	10	7.5	50
10760 00 28 Y1 00	12	8	50
10760 00 28 Y3 00	14	8.5	50
10760 00 28 Y4 00	15	9	50
10760 00 28 Y5 00	16	9.5	50
10760 00 28 Y7 00	18	10	50
10760 00 28 J1 00	22	10	50

## 10770

### BUSSOLA DI RINFORZO

INTERNAL SUPPORT BUSH  
STÜTZHÜLSE MESSING  
FOURRURE INTÉRIEURE  
REFUERZO  
BUCHA DE REFORÇO INTERNA

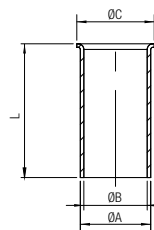

Code	Tube	A	B	C	L	Pack.
10770 00 01 1D 00	4/2.7	2.7	2.1	3.7	13	10
10770 00 01 3D 00	6/4	4	3.2	5	13	10
10770 00 01 4D 00	8/6	6	5	7	16.5	10
10770 00 01 5D 00	10/8	8	7	9	17	10
10770 00 01 7D 00	12/9	9	8	11	19	10
10770 00 01 8D 00	12/10	10	9	11	19	10
10770 00 01 0E 00	14/12	12	11	13.5	21	10
10770 00 01 1E 00	15/12.5	12.5	11.6	14	21	10
10770 00 01 3E 00	16/13	13	12	15.5	22	10
10770 00 01 7E 00	18/15	15	14	17.5	23	10
10770 00 01 8E 00	18/16	16	15	17.5	23	10
10770 00 01 0F 00	22/18	18	17	21	25	10

## 13780

### TAPPO PER RACCORDI UNIVERSALI

PLUG FOR UNIVERSAL FITTINGS  
STOPFEN FÜR DOPPELKEGEL VERSCHRAUBUNGEN  
BOUCHON POUR RACCORDS UNIVERSELS  
TAPÓN PARA RACORES UNIVERSALES  
TAMPÃO PARA CONEXÃO UNIVERSAIS

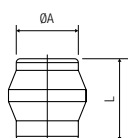

Code	Tube	L	Pack.
13780 00 01 X1 00	4	10	50
13780 00 01 X4 00	6	10.5	50
13780 00 01 X7 00	8	10.5	50
13780 00 01 X9 00	10	11.5	50
13780 00 01 Y1 00	12	12	50
13780 00 01 Y3 00	14	14	20
13780 00 01 Y4 00	15	14	20
13780 00 01 Y5 00	16	14	20
13780 00 01 Y7 00	18	16	20
13780 00 01 J1 00	22	15	20

## 1612

### RONDELLA BIMATERIALE IN ACCIAIO E NBR

STEEL AND NBR BIMATERIAL WASHER  
VERBUNDDICHTRINGE AUS STAHL UND NBR  
RONDELLE-JOINT BI-MATIÈRE (NBR - ACIER)  
ARANDELA BIMATERIAL EN ACERO Y NBR  
ARRUELA BI-MATERIAL EM AÇO E NBR

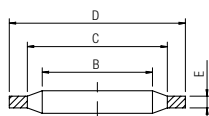

Code	Size	B	C	D	E	Pack.
01612 00 001	1/8	10.4	12	14.7	1.25	20
01612 00 002	1/4	13.85	15.75	18.7	1.25	20
01612 00 003	3/8	17.35	19.25	22.7	1.25	20
01612 00 004	1/2	21.65	23.55	26.7	1.25	20
01612 00 005	3/4	27.3	29.2	32.5	1.25	20
01612 00 006	1"	34.2	36.1	39.5	2	20



Temperature

min

- 30 °C

max

+ 100 °C

## 1613

### RONDELLA AUTOCENTRANTE BIMATERIALE IN ACCIAIO E NBR

STEEL AND NBR CENTERING BIMATERIAL WASHER  
BI-MATERIAL STAHL SCHEIBE UND NBR  
RONDELLE JOINT BI-MATIÈRE - ACIER/NBR  
ARANDELA BIMATERIAL EN ACERO Y NBR  
ARRUELA BI-MATERIAL EM AÇO E NBR

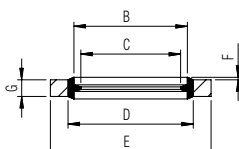

Code	Size	B	C	D	E	G	F	Pack.
01613 00 001	1/8	10,37	8,56	11,84	14	2	0,3	20
01613 00 002	1/4	13,74	11,45	15,21	17	2	0,3	20
01613 00 003	3/8	17,28	14,96	18,75	22	2	0,3	20
01613 00 004	1/2	21,54	18,64	23,01	26	2,5	0,4	20
01613 00 005	3/4	27,05	24,13	28,53	32	2,5	0,4	20
01613 00 006	1"	33,89	30,30	36,88	41	3,2	0,5	20



Temperature

min

- 30 °C

max

+ 100 °C