

Serie 40000V

 40005V Pag. 4.7	 40010V Pag. 4.7	 40020V Pag. 4.7	 40030V Pag. 4.8	 40040V Pag. 4.8	New  40050V Pag. 4.8	 40060V Pag. 4.9	 40106V Pag. 4.9	 40111V Pag. 4.9
 40116V Pag. 4.10	 40126V Pag. 4.10	 40130V Pag. 4.10	 40216V Pag. 4.11	 40226V Pag. 4.11	 40230V Pag. 4.11	 40310V Pag. 4.12	 40550V Pag. 4.12	 50600V Pag. 4.12
 CH028 Pag. 4.13	 50625 Pag. 4.13	 40700V Pag. 4.13	 57610 Pag. 4.14	 50980 Pag. 4.14				



CARATTERISTICHE TECNICHE
 TECHNICAL CHARACTERISTICS
 TECHNISCHE ANGABEN
 CARACTÉRISTIQUES TECHNIQUES
 CARACTERÍSTICAS TÉCNICAS
 CARACTERÍSTICAS TÉCNICAS



Norma di Riferimento
 Reference standard
 Entspricht der Norm
 Norme de référence
 Normativa de referencia
 Norma de referència

1907/2006
REACH ✓

2011/65/CE
RoHS ✓

PED
 2014/68/UE

ISO
 14743:2004

**SILICON
 FREE**

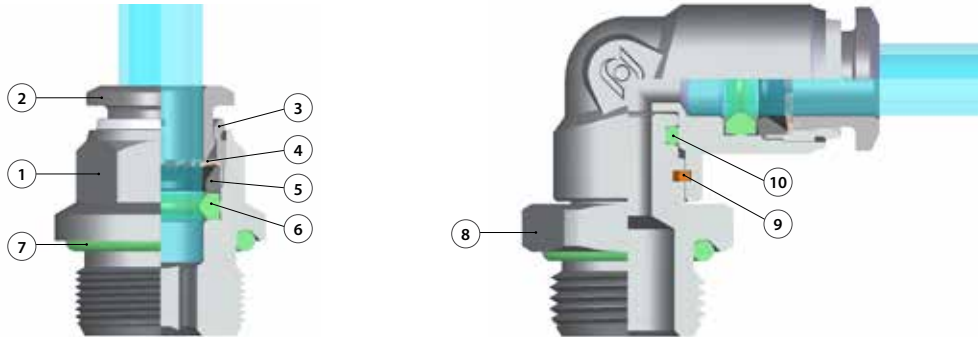

Materiali e Componenti	IT	Component Parts and Materials	GB	Komponenten und Materialien	DE
1 Corpo in ottone nichelato		1 Nickel-plated brass Body		1 Körper Messing vernickelt	
2 Spintore sgancio tubo in Ottone nichelato		2 Nickel-plated brass Collet		2 Druckring Messing vernickelt	
3 Capsula in ottone nichelato		3 Nickel-plated brass Capsule		3 Haltering Messing vernickelt	
4 Pinza d'aggraffaggio in acciaio inox AISI 301		4 Steel AISI 301 Clamping washer		4 Doppel-Zahnscheibe Edelstahl AISI 301	
5 Anello di posizionamento in tecnopolimero		5 Technopolymeric positioning ring		5 Positionierring Technopolymer	
6 Guarnizione sagomata in FKM		6 FKM Molded seal		6 Lippendichtung FKM	
7 Guarnizione filetto in FKM		7 FKM Thread packing		7 Gewindeabdichtung FKM	
8 Basetta Filettata in Ottone Nichelato		8 Base Threaded Nickel Plated Brass		8 Gewindebasis Messing vernickelt	
9 Seeger		9 Seeger		9 Seeger	
10 Guarnizione in FKM		10 FKM seal		10 O-Ringdichtung FKM	

Matériaux et Composants	FR	Materiales y Componentes	ES	Materiais e Componentes	PT
1 Corps: Laiton nickelé		1 Cuerpo en latón niquelado		1 Corpo em latão niquelado	
2 Poussoir: Laiton nickelé		2 Anillo de extracción tubo en latón niquelado		2 Anilha de liberação em latão niquelado	
3 Capsule de retenue: Laiton nickelé		3 Cápsula en latón niquelado		3 Cápsula de latão niquelado	
4 Rondelle d'accrochage: AISI 301		4 Doble pinza de agarre en acero inox AISI 301		4 Pinça de travamento em aço-inox AISI 301	
5 Anneau de positionnement: Technopolymère		5 Anillo de posicionamiento en tecnopolímero		5 Anel de posicionamento em tecnopolímero	
6 Joint à lèvres: FKM		6 Junta de forma en FKM		6 Vedação em FKM	
7 Joint d'étanchéité du filetage: FKM		7 Junta de la rosca en FKM		7 Vedação da rosca em FKM	
8 Bague de sécurité en laiton nickelé		8 Base roscada en latón niquelado		8 Base roscada em latão niquelado	
9 Seeger		9 Seeger		9 Seeger	
10 Joint en FKM		10 Junta tórica en FKM		10 Vedação em FKM	



Pressioni

Pressures
 Druckbereich
 Pressions
 Presiones
 Pressões

- 0.99 bar (-0.099 MPa)
30 bar (3.0 MPa)



Temperature

Temperatures
 Temperatur
 Températures
 Temperaturas
 Temperaturas

- 15 °C
+ 130 °C



Fluidi compatibili

Aria compressa / Vuoto / Acqua / Vapore

Fluids
 Compressed air / Vacuum / Water / Steam

Geeignete Medien
 Druckluft / Vakuum / Wasser / Dampf

Fluides compatibles
 Air comprimé / Vide / Eau / Vapeur

Fluidos compatibles
 Aire comprimido / Vacío / Agua / Vapor

Fluidos compatíveis
 Ar comprimido / Vácuo / Água / Vapor



Tubi di Collegamento	IT	Connection Tubes	GB	Geeignete Rohre	DE
Tubi in materiale plastico: PA6, PA11, PA12, Polietilene, *Poliuretano, PTFE, FEP. *Per tubi in Poliuretano è consigliata una durezza di 98 shore.		Plastic tubes: PA6, PA11, PA12, Polyethylene, *Polyurethane, PTFE, FEP. *For Polyurethane hoses it is required a minimum hardness of 98 shore.		Kunststoffrohre: PA6, PA11, PA 12, Polyethylene, *Polyurethan, PTFE, FEP. *Für Polyurethan Rohre ist eine Härte von 98 Shore empfohlen.	

Tubes Conseillés	FR	Tubos de Conexión	ES	Tubos de Conexão	PT
Tubes plastiques: PA6, PA11, PA12, Polyéthylène, *Polyuréthane, PTFE, FEP. *Pour les tubes en polyuréthane, il est conseillé une dureté de 98 Shore.		Tubos en material plástico: PA6, PA11, PA 12, Polietileno, *Poliuretano, PTFE, FEP. *Para tubos en poliuretano é aconsejada una dureza de 98 shore.		Tubos em material plástico: PA6, PA11, PA12, Polietileno, *Poliuretano, PTFE, FEP. *Para tubos em Poliuretano é requerida uma dureza de 98 shore.	



Filettatura IT Gas conica "UNIVERSAL SHORT". Gas cilindrica conforme ISO 228 Classe A. Metrica conforme ISO R/262.	Threads GB "UNIVERSAL SHORT" Tapered thread. Parallel gas in conformity with ISO 228 Class A. Metric in conformity with ISO R/262.	Gewindearten DE Konisches Gewinde "UNIVERSAL SHORT". Zylindrisches Gewinde nach Norm ISO 228 Classe A. Metrisches Gewinde nach Norm ISO R/262.
Filetages FR Filetage conique "UNIVERSAL SHORT". Filetage cylindrique conforme: ISO 228 Class A. Filetage métrique conforme: ISO R/262.	Roscas ES Gas cónica "UNIVERSAL SHORT". Gas cilíndrica conforme ISO 228 Clase A. Métrica conforme ISO R/262.	Roscas PT Gas cônica "UNIVERSAL SHORT". Gas paralela conforme ISO 228 Classe A. Métrica conforme ISO R/262.



UNIVERSAL SHORT

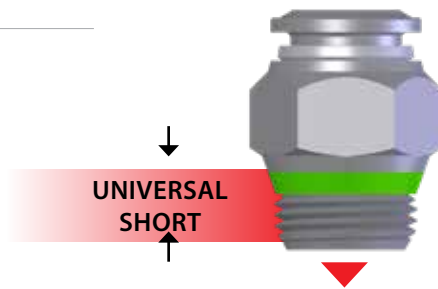

<p>NPT NPTF</p> <p>Conica Tapered Konisch Conique Cónica Cônica</p>	<p>ISO 7 BSPP</p> <p>Cilindrica Paralell Zylindrisch Cylindrique Cilíndrica Paralela</p>	<p>ISO 7 BSPT PT</p> <p>Conica Tapered Konisch Conique Cónica Cônica</p>	<p>ISO 228 BSP PF</p> <p>Cilindrica Paralell Zylindrisch Cylindrique Cilíndrica Paralela</p>
---	--	---	---

<p>"UNIVERSAL SHORT" IT</p> <p>La filettatura conica "UNIVERSAL SHORT" è progettata per soddisfare le seguenti caratteristiche:</p> <ul style="list-style-type: none"> • ridurre la lunghezza d'ingombro; • ridurre la chiave rispetto ad alcuni raccordi con filettature cilindriche; • consentire l'accoppiamento con diversi standard di filettature femmina sia coniche che cilindriche. 	<p>"UNIVERSAL SHORT" GB</p> <p>The "UNIVERSAL SHORT" tapered thread has been designed to offer the following advantages to the users:</p> <ul style="list-style-type: none"> • reduced overall length; • smaller hex dimensions compared to the parallel threads; • to allow the assembly with different female threads both taper as well as parallel. 	<p>"UNIVERSAL SHORT" DE</p> <p>Das konische Gewinde "UNIVERSAL SHORT" ist so konzipiert, dass folgende Vorteile erzielt werden:</p> <ul style="list-style-type: none"> • Reduzierung der Länge des Gewindes - kürzere Montagezeit; • Reduzierung der Schlüsselweite im Vergleich von Verschraubungen mit zylindrischen Gewinden - geringerer Lochabstand; • Ermöglicht den Einsatz in verschiedene Gewindearten, sowie in konische- und zylindrische Innengewinde.
---	--	---

<p>"UNIVERSAL SHORT" FR</p> <p>Le filetage conique "UNIVERSAL SHORT" a été conçu pour satisfaire les exigences suivantes:</p> <ul style="list-style-type: none"> • réduire la longueur d'encombrement; • réduire les dimensions hexagonales par rapport au filetage cylindrique; • permettre le montage avec divers taraudages standards soit coniques soit cylindriques. 	<p>"UNIVERSAL SHORT" ES</p> <p>La rosca cónica "UNIVERSAL SHORT" ha sido proyectada para satisfacer las siguientes características:</p> <ul style="list-style-type: none"> • reducir la longitud; • reducir la llave respecto a algunos racores con rosca cilíndrica; • consentir el acoplamiento con diferentes standard de roscas hembra sean cónicas o cilíndricas. 	<p>"UNIVERSAL SHORT" PT</p> <p>A rosca cônica "UNIVERSAL SHORT" é projetada para satisfazer às seguintes características:</p> <ul style="list-style-type: none"> • reduzir o comprimento da conexão; • reduzir o dimensional com relação às roscas paralelas; • permitir o acoplamento da conexão a diferentes tipos de rosca fêmea, sejam elas cónicas ou paralelas.
--	---	--



<p>IT</p> <p>Consentire una completa tenuta anche su superfici non perfettamente piane, concave, convesse o inclinate, con diversi smussi o raggi.</p>	<p>GB</p> <p>To ensure the right tightening also with surfaces not perfectly flat, without spot-facing, concave convex and with different kinds of chamfers or radius.</p>	<p>DE</p> <p>Eine vollständige Abdichtung ist auch auf unebenen Flächen, wie geneigt, konkav oder konvex und mit unterschiedlichen Radien oder Fasen gewährleistet.</p>
<p>FR</p> <p>Pour permettre une parfaite étanchéité même sur des surfaces non planes, concaves, convexas ou inclinées et avec différents chanfreins ou rayons.</p>	<p>ES</p> <p>Consentir una completa estanqueidad incluso en superficies no perfectamente planas, cóncavas, convexas o inclinadas, con diferentes ángulos o radios.</p>	<p>PT</p> <p>Permite um aperto correto em superfícies não perfeitamente planas, côncavas, convexas ou inclinadas, com diferentes chanfros ou raios.</p>



Coppia di serraggio

Torque specifications

Angaben Drehmoment

Couple de serrage

Par de apriete

Especificações de Torque



ISO 228



"UNIVERSAL SHORT"

I valori di rottura possono variare in base all'articolo
Breaking values may vary according to the item
 Die maximal werte dienen nur zu Informationszwecken
 Les valeurs maximales sont présentées à titre indicatif
 Los valores de rotura pueden variar en función del artículo
 Os valores de ruptura podem variar em função do item

MISURA MEASURE GRÖSSE DIMENSIONS MEDIDA MEDIDA	COPPIA CONSIGLIATA Nm RECOMMENDED TORQUE Nm EMPFOHLENES DREHMOMENT Nm COUPLE DE SERRAGE Nm PAR ACONSEJADO Nm TORQUE RECOMENDADO Nm	COPPIA DI ROTTURA Nm BREAKING TORQUE Nm ABSCHERDREHMOMENT Nm COUPLE DE RUPTURE Nm PAR DE ROTURA Nm TORQUE DE RUPTURA Nm
M5	0,8	3,2
1/8	3	8
1/4	9	30
3/8	10	60
1/2	12	50

MISURA MEASURE GRÖSSE DIMENSIONS MEDIDA MEDIDA	COPPIA MINIMA CONSIGLIATA Nm RECOMMENDED MINIMUM TORQUE Nm EMPFOHLENES DREHMOMENT Nm COUPLE DE SERRAGE Nm PAR MÍNIMO ACONSEJADO Nm TORQUE MÍNIMO RECOMENDADO Nm	COPPIA MASSIMA CONSIGLIATA Nm RECOMMENDED MAX TORQUE Nm ABSCHERDREHMOMENT Nm COUPLE DE RUPTURE Nm PAR MÁXIMO ACONSEJADO Nm TORQUE MÁXIMA RECOMENDADO Nm
1/8	5	7
1/4	5	7
3/8	5	7
1/2	5	7

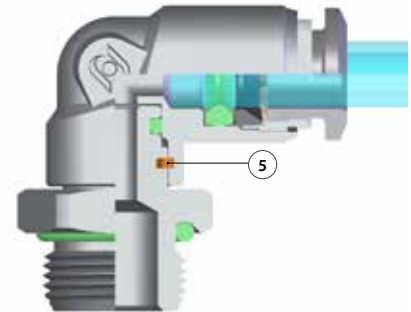
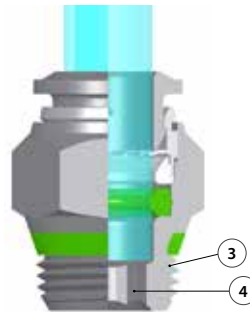
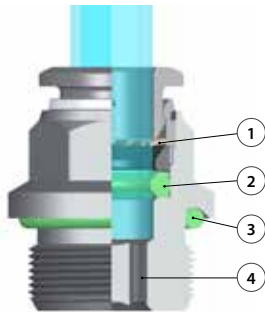

Vantaggi

IT

- 1 La pinza in acciaio inox garantisce il perfetto aggraffaggio di tubi di qualsiasi materiale senza danneggiarne la superficie. Il collegamento tra tubo e raccordo assicura una tenuta totale anche in condizioni di urti e vibrazioni.
- 2 La particolare geometria della guarnizione permette inoltre l'utilizzo dei raccordi anche con il vuoto.
- 3 Tutte le filettature di questa serie sono state dotate di elementi di tenuta che permettono l'immediato utilizzo dei raccordi riducendo notevolmente i tempi di installazione.
- 4 Tutti i raccordi dritti possono essere montati anche con chiave esagonale ed è possibile utilizzarli anche in spazi molto ridotti.
- 5 Raccordo orientabile con anello di sicurezza interno. Garantisce maggiore durata alla rotazione e trazione.

Advantages

GB

- 1 The washer is made in stainless steel ensures the perfect tube clamping with every kinds of materials without damage the surface. The connection between the tube and the fitting ensure a total tightness even in severe conditions such as impact and vibrations.
- 2 The particular geometric shape of the seal ensure the perfect tightness even with vacuum.
- 3 All of threads from this range have been equipped with tightening parts which allow the direct assembly of the fittings, reducing the installation time.
- 4 All the straight fittings can be assembled also with Allen wrench and it is possible to use them in reduced spaces.
- 5 Orienting fitting with safety ring inside. Improved durability to the rotation and traction.

Vorteile

DE

- 1 Konisches Gewinde "kurz" Die Zahnscheibe sorgt für eine perfekte Halterung des Rohres ohne die Oberfläche zu beschädigen. Die Dichtheit zwischen Rohr und Verschraubung ist auch bei Erschütterungen und Vibrationen gewährleistet.
- 2 Die besondere Geometrie der Dichtung ermöglicht auch die Anwendung der Verschraubungen in Verbindung mit Vakuum.
- 3 Alle Verschraubungen in dieser Serie sind mit Gewindeabdichtungen ausgestattet, die den sofortigen Einsatz ermöglichen und daher die Montagezeit stark reduzieren.
- 4 Alle geraden Verschraubungen können auch mit Inbusschlüsseln montiert werden, daher kleiner Lochabstand möglich.
- 5 Flexible Montage mit Sicherungsring innen. Verbesserte Beständigkeit gegenüber der Drehung und Traktions.

Avantages

FR

- 1 La rondelle en acier inoxydable garantit la parfaite tenue du tube quelle que soit la matière et sans l'endommager. La connexion entre le tube et le raccord assure une étanchéité totale même dans des conditions d'impact ou de vibrations.
- 2 La spécificité géométrique du joint permet l'utilisation des raccords avec le vide.
- 3 Tous les filetages de cette série sont équipés d'éléments d'étanchéité qui permettent l'utilisation immédiate des raccords réduisant ainsi le temps d'installation.
- 4 Tous les raccords droits peuvent être aussi montés avec une clé hexagonale pour permettre une utilisation dans des espaces réduits.
- 5 Accessoire de fixation réglable avec anneau de sécurité à l'intérieur. Amélioration de la durée de la rotation et de traction.

Ventajas

ES

- 1 La pinza en acero inox garantiza el perfecto agarre del tubo de cualquier material sin perjudicar la superficie. La conexión entre tubo y racor asegura una estanqueidad total aun en condiciones de impacto o vibración.
- 2 La particular geometría de la junta garantiza una perfecta estanqueidad incluso en vacío.
- 3 Todas las rosas de esta serie están fabricadas con junta de cierre que permite la inmediata utilización del racor reduciendo notablemente el tiempo de instalación.
- 4 Todos los racores rectos pueden montarse también con llave hexagonal y es posible utilizarlos incluso en espacios muy reducidos.
- 5 Montaje ajustable con sistema de seguridad interior. La mejora de la durabilidad a la rotación y tracción.

Vantagens

PT

- 1 A pinça em aço-inox garante o perfeito travamento do tubo de qualquer material sem danificar a superfície do mesmo. A conexão entre o tubo e a conexão assegura uma vedação total também em condições de impactos e vibrações.
- 2 A geometria particular da vedação permite a utilização da conexão também para aplicações com vácuo.
- 3 Todas as rosas desta série são dotadas de elementos de vedação, o que permite a imediata utilização das conexões, reduzindo notavelmente o tempo de instalação.
- 4 Todas as conexões retas podem ser montadas também com chave allenando possível montagem das mesmas em espaços bem reduzidos.
- 5 Montagem ajustável com anel de segurança dentro. A durabilidade melhorada para a rotação e tração.

40005V

RACCORDO DIRITTO MASCHIO "UNIVERSAL SHORT"

STRAIGHT MALE ADAPTOR "UNIVERSAL SHORT"
 GERADE EINSCHRAUBVERSCHRAUBUNG KONISCH "UNIVERSAL SHORT"
 RACCORD DROIT MÂLE, CONIQUE "UNIVERSAL SHORT"
 RACOR RECTO MACHO CÓNICO "UNIVERSAL SHORT"
 CONEXÃO RETA COM ROSCA "UNIVERSAL SHORT"

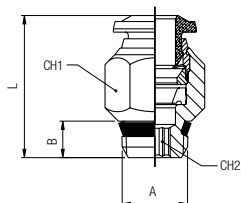

Code	Tube	A	B	L	CH1	CH2	Pack.
40005 V0 002	6	1/8	5.5	21.5	13	4	10
40005 V0 004	8	1/8	5.5	24.5	14	5	10
40005 V0 005	8	1/4	7	22	14	6	10
40005 V0 007	10	1/4	7	28	17	7	10
40005 V0 017	10	1/2	9	26	21	8	10
40005 V0 009	12	1/4	7	31.5	20	7	10
40005 V0 010	12	3/8	7.5	29.5	20	9	10

40010V

RACCORDO DIRITTO MASCHIO CILINDRICO ESAGONO INCASSATO

STRAIGHT MALE ADAPTOR (PARALLEL) WITH EXAGON EMBEDDED
 GERADE EINSCHRAUBVERSCHRAUBUNG MIT INNENSECHSKANT ZYLINDRISCH
 RACCORD DROIT MÂLE, CYLINDRIQUE, 6-PANS INTERIEUR
 RACOR RECTO MACHO CILÍNDRICO HEXÁGONO INTERIOR
 CONEXÃO RETA COM SEXTAVADO INTERNO E ROSCA MÉTRICA

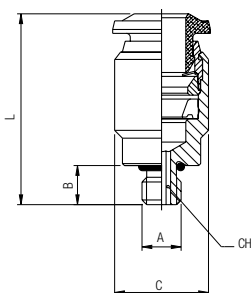

Code	Tube	A	B	C	L	CH	Pack.
40010 V0 001	4	M5	4	10	21	2.5	10
40010 V0 007	6	M5	4	12	24.5	2.5	10

40020V

RACCORDO DIRITTO MASCHIO CILINDRICO

STRAIGHT MALE ADAPTOR (PARALLEL)
 GERADE EINSCHRAUBVERSCHRAUBUNG ZYLINDRISCH
 RACCORD DROIT MÂLE, CYLINDRIQUE
 RACOR RECTO MACHO CILÍNDRICO CON TÓRICA
 CONEXÃO RETA COM ROSCA PARALELA

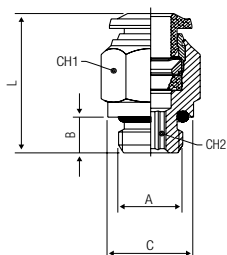

Code	Tube	A	B	C	L	CH1	CH2	Pack.
40020 V0 001	4	M5	3.6	8	20	10	2	10
40020 V0 037	4	M6X1	4.8	10	20	10	2.5	10
40020 V0 033	4	M8X1	5.4	12	18.5	10	3	10
40020 V0 002	4	1/8	5.4	13	20	10	3	10
40020 V0 022	4	1/4	7.1	16	19.5	16	3	10
40020 V0 020	6	M5	3.6	10	26.5	13	2	10
40020 V0 003	6	1/8	5.4	13	23.5	13	4	10
40020 V0 004	6	1/4	7.1	16	23.5	13	4	10
40020 V0 027	6	3/8	8.1	20	25	13	4	10
40020 V0 028	6	1/2	9.6	25	27	13	4	10
40020 V0 005	8	1/8	5.4	13	25	14	5	10
40020 V0 006	8	1/4	7.1	16	23	14	6	10
40020 V0 007	8	3/8	8.1	20	24	14	6	10
40020 V0 029	8	1/2	9.6	25	26.5	14	6	10
40020 V0 008	10	1/4	7.1	16	30.5	17	6	10
40020 V0 009	10	3/8	8.1	20	27.5	17	8	10
40020 V0 031	10	1/2	9.6	25	27	17	8	10
40020 V0 032	12	1/4	7.1	16	34.5	20	6	10
40020 V0 011	12	3/8	8.1	20	34	20	8	10
40020 V0 023	12	1/2	9.6	25	31	22	10	10
40020 V0 024	14	3/8	8.1	20	35	21	10	10
40020 V0 025	14	1/2	9.6	25	32	22	11	10

40030V

RACCORDO DIRITTO FEMMINA

STRAIGHT FEMALE ADAPTOR
 AUFSCHRAUBVERSCHRAUBUNG
 RACCORD DROIT, TARAUDE
 RACOR RECTO HEMBRA
 CONEXÃO RETA COM ROSCA FÊMEA

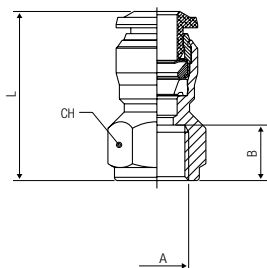

Code	Tube	A	B	L	CH	Pack.
40030 V0 008	4	M5	5.5	21	11	10
40030 V0 001	4	1/8	8.5	24	13	10
40030 V0 009	4	1/4	11	27.5	16	10
40030 V0 002	6	1/8	8.5	26	13	10
40030 V0 007	6	1/4	11	29.5	16	10
40030 V0 004	8	1/8	8.5	27	15	10
40030 V0 005	8	1/4	11	29.5	17	10
40030 V0 010	8	3/8	12	32	19	10
40030 V0 011	10	1/4	11	32	18	10
40030 V0 012	10	3/8	12	33.5	19	10
40030 V0 013	10	1/2	15	39	24	10
40030 V0 014	12	3/8	12	36	21	10
40030 V0 015	12	1/2	15	41	24	10

40040V

RACCORDO DIRITTO INTERMEDIO

STRAIGHT CONNECTOR
 VERBINDUNGSVERSCHRAUBUNG
 RACCORD UNION DOUBLE
 RACOR RECTO INTERMEDIO
 CONEXÃO RETA TUBO-TUBO

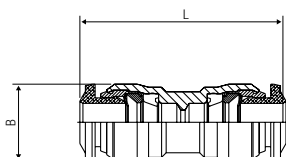

Code	Tube	Tube	L	B	Pack.
40040 V0 001	4 (5/32)	4 (5/32)	30.5	10.5	10
40040 V0 002	6	4	32	12.5	10
40040 V0 003	6	6	34	12.5	10
40040 V0 004	8	6	35	14.5	10
40040 V0 005	8 (5/16)	8 (5/16)	36	14.5	10
40040 V0 011	10	8	40.5	17.5	10
40040 V0 006	10	10	42	17.5	10
40040 V0 012	12	10	45.5	20.5	10
40040 V0 007	12	12	47	20.5	10
40040 V0 010	14	14	49	21.5	10

40050V

New

RACCORDO DIRITTO INTERMEDIO DI ATTRAVERSAMENTO

BULKHEAD CONNECTOR
 SCHOTTVERSCHRAUBUNG
 RACCORD TRAVERSÉE DE CLOISON
 RACOR RECTO INTERMEDIO PASATABIQUES
 CONEXÃO PASSA-MURO RETA TUBO-TUBO

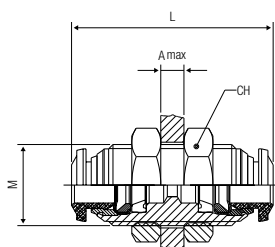

Code	Tube	M	L	CH	A _{max}	Pack.
40050 V0 001	4 (5/32)	M12x1	31.5	17	7	10
40050 V0 002	6	M14x1	35	17	9.5	10
40050 V0 009	8(5/16)-6	M16x1	37	19	10.5	10
40050 V0 003	8(5/16)	M16x1	37	19	10.5	10
40050 V0 010	10-6	M20x1	43	24	11.5	10
40050 V0 011	10-8	M20x1	43	24	12.5	10
40050 V0 004	10	M20x1	43	24	12.5	10
40050 V0 005	12	M22x1	48	26	16.5	10

40060V

RACCORDO A L ORIENTABILE INTERMEDIO DI ATTRAVERSAMENTO

BULKHEAD ORIENTING ELBOW

WINKEL-SCHOTTVERSCHRAUBUNG (DREHBAR)

RACCORD EQUERRE ORIENTABLE A TRAVERSEE DE CLOISON

RACOR A L ORIENTABLE INTERMEDIO PASATABIQUES

CONEXÃO PASSA-MURO EM "L" ORIENTÁVEL

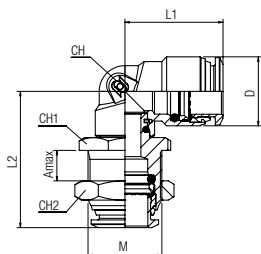

Code	Tube	M	L1	L2	D	CH	CH1	CH2	Amax	Pack.
40060 V0 003	4	M12x1	17.5	26	10	9	14	17	6	10
40060 V0 004	6	M14x1	21.5	31	12.5	11	16	17	6.5	10
40060 V0 005	8	M16x1	22	34	14.5	12	18	19	6.5	10
40060 V0 006	10	M20x1	26.5	36	17.5	14	22	24	7.5	10
40060 V0 007	12	M22x1	30.5	43	21.5	16	24	26	9	10
40060 V0 008	14	M23x1	30.5	43	21.5	16	25	27	9.5	10

40106V

RACCORDO A L ORIENTABILE FEMMINA

ORIENTING ELBOW FEMALE ADAPTOR

AUFSCRAUB-WINKELSCHRAUBUNG (DREHBAR)

RACCORD EQUERRE ORIENTABLE TARAUDE

RACOR A L ORIENTABLE HEMBRA

CONEXÃO EM "L" ORIENTÁVEL COM ROSCA FÊMEA

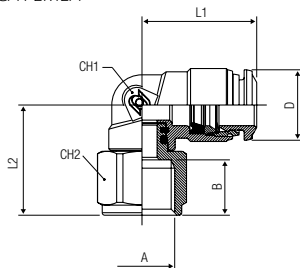

Code	Tube	A	B	L1	L2	CH1	CH2	D	Pack.
40106 V0 001	4	1/8	8.5	18	20	9	13	10	10
40106 V0 002	4	1/4	11	18	21.5	9	16	10	10
40106 V0 003	6	1/8	8.5	21	20.5	11	13	12.5	10
40106 V0 004	6	1/4	11	21	23	11	16	12.5	10
40106 V0 005	8	1/8	8.5	22.5	20.5	12	13	14.5	10
40106 V0 006	8	1/4	11	22.5	23	12	16	14.5	10

40111V

RACCORDO A L ORIENTABILE MASCHIO "UNIVERSAL SHORT"

ORIENTING ELBOW MALE ADAPTOR "UNIVERSAL SHORT"

WINKELVERSCHRAUBUNG KONISCH (DREHBAR) "UNIVERSAL SHORT"

EQUERRE ORIENTABLE MÂLE, CONIQUE "UNIVERSAL SHORT"

RACOR A L ORIENTABLE MACHO "UNIVERSAL SHORT"

CONEXÃO MACHO EM "L" ORIENTÁVEL COM ROSCA "UNIVERSAL SHORT"

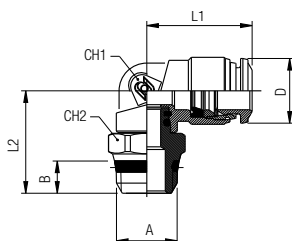

Code	Tube	A	B	L1	L2	CH1	CH2	D	Pack.
40111 V0 003	4	1/8	5.5	18	19.5	9	13	10	10
40111 V0 002	4	1/4	7	18	21	9	15	10	10
40111 V0 004	6	1/8	5.5	21	21.5	11	13	12.5	10
40111 V0 005	6	1/4	7	21	23	11	15	12.5	10
40111 V0 006	8	1/8	5.5	22.5	22.5	12	13	14.5	10
40111 V0 007	8	1/4	7	22.5	22.5	12	15	14.5	10
40111 V0 008	8	3/8	7.5	22.5	23	12	17	14.5	10
40111 V0 009	8	1/2	9	22.5	25.5	12	21	14.5	10
40111 V0 010	10	1/4	7	26.5	26.5	14	16	17.5	10
40111 V0 011	10	3/8	7.5	26.5	24.5	14	17	17.5	10
40111 V0 012	10	1/2	9	26.5	27	14	21	17.5	10
40111 V0 013	12	3/8	7.5	31.5	26.5	16	20	21.5	10
40111 V0 014	12	1/2	9	31.5	29	16	21	21.5	10
40111 V0 015	14	3/8	7.5	31.5	27	16	20	21.5	10
40111 V0 016	14	1/2	9	31.5	29.5	16	21	21.5	10