

Serie 40000V

 40005V Pag. 4.7	 40010V Pag. 4.7	 40020V Pag. 4.7	 40030V Pag. 4.8	 40040V Pag. 4.8	 40050V Pag. 4.8	 40060V Pag. 4.9	 40106V Pag. 4.9	 40111V Pag. 4.9
 40116V Pag. 4.10	 40126V Pag. 4.10	 40130V Pag. 4.10	 40216V Pag. 4.11	 40226V Pag. 4.11	 40230V Pag. 4.11	 40310V Pag. 4.12	 40550V Pag. 4.12	 50600V Pag. 4.12
 CH028 Pag. 4.13	 50625 Pag. 4.13	 40700V Pag. 4.13	 57610 Pag. 4.14	 50980 Pag. 4.14				

RACCORDI AUTOMATICI METALLICI CON GUARNIZIONI FKM

METALLIC PUSH-IN FITTINGS WITH FKM SEAL

VOLLMETALL STECKVERSCHRAUBUNGEN MIT FKM DICHTUNGEN

RACCORDS INSTANTANÉS TOUT LAITON NICKELÉ JOINT FKM

RACORDAJE AUTOMÁTICO METÁLICO CON JUNTAS FKM

CONEXÕES PUSH-IN METÁLICAS COM VEDAÇÕES EM FKM

Bar  30 Bar



Serie 40000V

40000V

La serie 40000V, risponde alle esigenze del mercato dove si rende necessario un componente "High Performance". Un sistema di aggraffaggio del tubo altamente performante che consente di lavorare a pressioni elevate e sotto sforzo. Questa gamma deriva dallo sviluppo di applicazioni alta temperatura con PN 30 bar. Completamente in ottone nichelato, con tenute in FKM, in caso di presenza di vibrazioni, questa gamma garantisce la migliore tenuta, sia in pressione che con vuoto.

Principali vantaggi

- Utilizzabile con gas inerti e liquidi compatibili con i materiali costituenti
- Connessione e sconnessione istantanea
- Pieno passaggio e tenuta al vuoto grazie alle guarnizioni sagomate
- Due tipologie di filettature, BSPP e Metrica
- Alta Resistenza alle temperatura e pressione
- Silicon Free

Applicazioni

- Aria, acqua di raffreddamento, vuoto e vapore
- Automazione pneumatica in ambienti alta temperatura
- Automotive e Saldatura
- Industria Pesante, applicazioni gravose
- Presenza forti vibrazioni

The 40000V serie is considered an "High Performance" line in terms of pressure and temperature. Ideal for application with high temperature and pressure up to 30 bar.

Seals are FKM and clamping washers are double-performant to withstand to high pressure and traction.

Better sealing is guaranteed in case of strong vibrations and vacuum.

Main advantages

- Inert gases and Liquids compatible
- Quick connection and disconnection
- Full Flow and Vacuum resistant tank to special shaped seals
- 2 threads available, BSPP & Metric
- High resistance to temperature and pressure
- Silicon Free

Applications

- Compressed Air, Cooling Water, Vacuum, Steam
- Pneumatic automation with high temperature
- Automotive & Welding
- Heavy Duty Industry
- Vibrations environment

Die 40000V Serie ist eine "High Performance" Linie in Bezug auf Druck und Temperatur.

Ideal für Anwendungen mit hoher Temperatur und Druck bis zu 30 bar.

Die Dichtungen sind aus FKM und Spanscheiben sind doppelt-performant, um gegen hohen Druck und Zug zu bestehen.

Bessere Abdichtung bei starken Vibrationen und Vakuum wird garantiert.

Hauptvorteile

- Kompatibel für Inertgase und Flüssigkeiten
- Schnelle Verbindung und Trennung
- Voller Durchfluss und Vakuumfestigkeit, dank spezieller Formdichtungen
- Zwei Gewindearten, BSPP und metrisch
- Sehr temperatur- und druckbeständig
- Silikonfrei

Anwendungen

- Druckluft, Kühlwasser, Vakuum, Dampf
- Pneumatische Automation mit hohen Temperaturen
- Automobil-Industrie und Schweißen
- Schwerindustrie
- Umgebung mit Vibrationen

La série 40000V est considérée comme la gamme "Haute Performance" en termes de pression et de température. Idéale pour les températures élevées et une Pression Nominale de 30 bar maxi. En laiton nickelé avec joints FKM en standard, la série dispose d'un système de maintien à haute performance qui vous permet de travailler à des pressions élevées. En présence de vibrations, cette gamme assure également une parfaite étanchéité, sous pression et sous vide.

Principaux avantages

- Peut être utilisé avec des gaz inertes et liquides compatibles avec les matériaux
- Connexion et déconnexion instantanée
- Plein débit et tenue au vide grâce à des joints de forme
- Deux types de filetages, BSPP et métrique
- Haute résistance à la température et pression
- Sans Silicone

Applications

- Air, eau de refroidissement, vide
- Automatisme pneumatique avec des températures élevées
- Automobile et soudage (ferrage)
- Industries lourdes
- Bonne tenue aux vibrations

La serie 40000V Aignep, responde a las exigencias del mercado donde se requiere un componente "High Performance" ya sea en términos de presión que de temperatura. Esta gama deriva del desarrollo de aplicaciones en alta temperatura con PN de 30 bar. Completamente en latón niquelado, con juntas de FKM de serie, la serie tiene un sistema de agarre del tubo de alto rendimiento que consiente trabajar en altas presiones y bajo esfuerzo. En caso de presencia de vibraciones, esta gama garantiza la mejor estanqueidad, ya sea en presión como en vacío.

Principales ventajas

- Utilizable con gases inertes y líquidos compatibles con el material constituyente
- Conexión y desconexión instantánea
- Paso total y estanqueidad al vacío gracias a las juntas moldeadas
- Dos tipos de roscas, BSPP y métrica
- Alta resistencia a la temperatura y presión
- Libre de silicona

Aplicaciones

- Aire, agua de refrigeración, vacío y vapor
- Automatización neumática en ambientes de alta temperatura
- Automoción y soldadura
- Industria pesada, aplicaciones gravosas
- Presencia de fuertes vibraciones

A série 40000V é considerada uma linha de "Alta Performance" em termos de pressão e temperatura. Ideal para aplicações com alta temperatura e pressões até 30 bar. As vedações são em FKM e as garras de travamento do tubo possuem alta performance tanto em altas pressões como em aplicações envolvendo tração. Vedações diferenciadas garantem performances mesmo em casos de fortes vibrações e vácuo.

Principais vantagens

- Gases inertes e líquidos compatíveis
- Rápida conexão e desconexão
- Vazão Total e resistência ao vácuo graças ao design de suas vedações
- 2 roscas disponíveis, BSPP e MÉTRICA
- Alta resistência a temperatura e pressão
- Livre de Silicone

Aplicações

- Ar Comprimido, Água de Resfriamento, Vácuo, Vapor
- Pneumática Automação com Alta Temperatura
- Automotiva & Solda
- Indústria Pesada
- Ambientes com Vibração



CARATTERISTICHE TECNICHE

TECHNICAL CHARACTERISTICS
TECHNISCHE ANGABEN
CARACTÉRISTIQUES TECHNIQUES
CARACTERÍSTICAS TÉCNICAS
CARACTERÍSTICAS TÉCNICAS



Norma di Riferimento

Reference standard

Entspricht der Norm

Norme de référence

Normativa de referencia

Norma de referència

1907/2006

REACH ✓

2011/65/CE

RoHS ✓

PED
2014/68/UE

ISO
14743:2020

SILICON
FREE

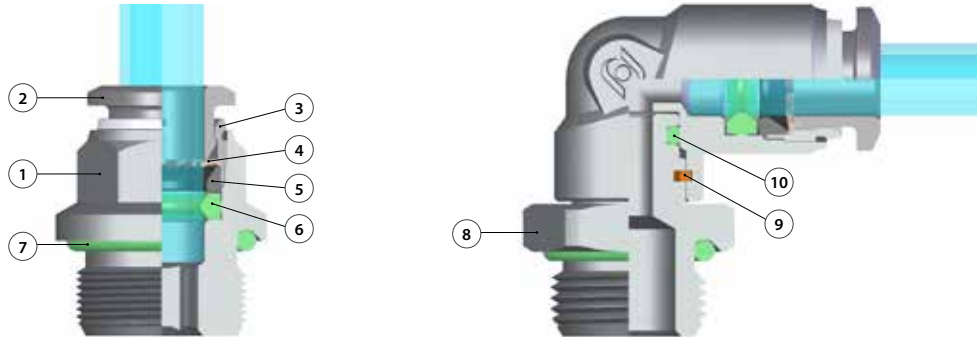

Materiali e Componenti

IT

- 1 Corpo in ottone nichelato
- 2 Spintore sgancio tubo in Ottone nichelato
- 3 Capsula in ottone nichelato
- 4 Pinza d'aggraffaggio in acciaio inox AISI 301
- 5 Anello di posizionamento in tecnopolimero
- 6 Guarnizione sagomata in FKM
- 7 Guarnizione filetto in FKM
- 8 Basetta Filettata in Ottone Nichelato
- 9 Seeger
- 10 Guarnizione in FKM

Component Parts and Materials

GB

- 1 Nickel-plated brass Body
- 2 Nickel-plated brass Collet
- 3 Nickel-plated brass Capsule
- 4 Steel AISI 301 Clamping washer
- 5 Technopolymeric positioning ring
- 6 FKM Molded seal
- 7 FKM Thread packing
- 8 Base Threaded Nickel Plated Brass
- 9 Seeger
- 10 FKM seal

Komponenten und Materialien

DE

- 1 Körper Messing vernickelt
- 2 Druckring Messing vernickelt
- 3 Haltering Messing vernickelt
- 4 Doppel-Zahnscheibe Edelstahl AISI 301
- 5 Positionierring Technopolymer
- 6 Lippendichtung FKM
- 7 Gewindeabdichtung FKM
- 8 Gewindebasis Messing vernickelt
- 9 Seeger
- 10 O-Ringdichtung FKM

Matériaux et Composants

FR

- 1 Corps: Laiton nickelé
- 2 Poussoir: Laiton nickelé
- 3 Capsule de retenue: Laiton nickelé
- 4 Rondelle d'accrochage: AISI 301
- 5 Anneau de positionnement: Technopolymère
- 6 Joint à lèvres: FKM
- 7 Joint d'étanchéité du filetage: FKM
- 8 Bague de sécurité en laiton nickelé
- 9 Seeger
- 10 Joint en FKM

Materiales y Componentes

ES

- 1 Cuerpo en latón niquelado
- 2 Anillo de extracción tubo en latón niquelado
- 3 Cápsula en latón niquelado
- 4 Doble pinza de agarre en acero inox AISI 301
- 5 Anillo de posicionamiento en tecnopolímero
- 6 Junta de forma en FKM
- 7 Junta de la rosca en FKM
- 8 Base roscada en latón niquelado
- 9 Seeger
- 10 Junta tórica en FKM

Materiais e Componentes

PT

- 1 Corpo em latão niquelado
- 2 Anilha de liberação em latão niquelado
- 3 Cápsula de latão niquelado
- 4 Pinça de travamento em aço-inox AISI 301
- 5 Anel de posicionamento em tecnopolímero
- 6 Vedação em FKM
- 7 Vedação da rosca em FKM
- 8 Base roscada em latão niquelado
- 9 Seeger
- 10 Vedação em FKM



Pressioni

Pressures

Druckbereich

Pressions

Presiones

Pressões

- 0.99 bar (-0.099 MPa)

30 bar (3.0 MPa)



Temperature

Temperatures

Temperatur

Températures

Temperaturas

Temperaturas

- 15 °C

+ 130 °C



Fluidi compatibili

Aria compressa / Vuoto / Acqua

Fluids

Compressed air / Vacuum / Water

Geeignete Medien

Druckluft / Vakuum / Wasser

Fluides compatibles

Air comprimé / Vide / Eau

Fluidos compatibles

Aire comprimido / Vacío / Agua

Fluidos compatíveis

Ar comprimido / Vácuo / Água



Tubi di Collegamento

IT

Tubi in materiale plastico:

PA6, PA11, PA12, Polietilene, *Poliuretano, PTFE, FEP.

*Utilizzo da 90 a 98 Shore, per la massima prestazione è consigliato 98 Shore A.

Connection Tubes

GB

Plastic tubes:

PA6, PA11, PA12, Polyethylene, *Polyurethane, PTFE, FEP.

*Use from 90 to 98 Shore, for maximum performance is recommended 98 Shore A.

Geeignete Rohre

DE

Kunststoffrohre:

PA6, PA11, PA12, Polyethylene, *Polyurethan, PTFE, FEP.

*Verwenden Sie 90 bis 98 Shore, für maximale Leistung wird 98 Shore A empfohlen.

Tubes Conseillés

FR

Tubes plastiques:

PA6, PA11, PA12, Polyéthylène, *Polyuréthane, PTFE, FEP.

*Utilisation de 90 à 98 Shore, pour une performance maximale recommandée 98 Shore A.

Tubos de Conexión

ES

Tubos en material plástico:

PA6, PA11, PA12, Polietileno, *Poliuretano, PTFE, FEP.

*Uso de 90 a 98 Shore, para un máximo rendimiento se recomienda 98 Shore A.

Tubos de Conexão

PT

Tubos em material plástico:

PA6, PA11, PA12, Polietileno, *Poliuretano, PTFE, FEP.

*Uso de 90 a 98 Shore, para o desempenho máximo é recomendado 98 Shore A.



Filettatura Gas conica "UNIVERSAL SHORT". Gas cilindrica conforme ISO 228 Classe A. Metrica conforme ISO R/262.	IT	Threads "UNIVERSAL SHORT" Tapered thread. Parallel gas in conformity with ISO 228 Class A. Metric in conformity with ISO R/262.	GB	Gewindearten Konisches Gewinde "UNIVERSAL SHORT". Zylindrisches Gewinde nach Norm ISO 228 Classe A. Metrisches Gewinde nach Norm ISO R/262.	DE
Filetages Filetage conique "UNIVERSAL SHORT". Filetage cylindrique conforme: ISO 228 Classe A. Filetage métrique conforme: ISO R/262.	FR	Roscas Gas cónica "UNIVERSAL SHORT". Gas cilíndrica conforme ISO 228 Clase A. Métrica conforme ISO R/262.	ES	Roscas Gas cónica "UNIVERSAL SHORT". Gas paralela conforme ISO 228 Classe A. Métrica conforme ISO R/262.	PT



UNIVERSAL SHORT

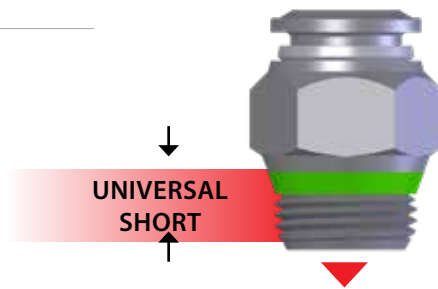

<p>NPT NPTF</p>	Conica Tapered Konisch Conique Cónica Cônica	<p>ISO 7 BSPP</p>	Cilindrica Parallell Zylindrisch Cylindrique Cilíndrica Paralela	<p>ISO 7 BSPT PT</p>	Conica Tapered Konisch Conique Cónica Cônica	<p>ISO 228 BSP PF</p>	Cilindrica Parallell Zylindrisch Cylindrique Cilíndrica Paralela
-----------------------------------	---	-------------------------------------	---	---	---	--	---

"UNIVERSAL SHORT" La filettatura conica "UNIVERSAL SHORT" è progettata per soddisfare le seguenti caratteristiche: <ul style="list-style-type: none"> • ridurre la lunghezza d'ingombro; • ridurre la chiave rispetto ad alcuni raccordi con filettature cilindriche; • consentire l'accoppiamento con diversi standard di filettature femmina sia coniche che cilindriche. 	IT	"UNIVERSAL SHORT" The "UNIVERSAL SHORT" tapered thread has been designed to offer the following advantages to the users: <ul style="list-style-type: none"> • reduced overall length; • smaller hex dimensions compared to the parallel threads; • to allow the assembly with different female threads both taper as well as parallel. 	GB	"UNIVERSAL SHORT" Das konische Gewinde "UNIVERSAL SHORT" ist so konzipiert, dass folgende Vorteile erzielt werden: <ul style="list-style-type: none"> • Reduzierung der Länge des Gewindes - kürzere Montagezeit; • Reduzierung der Schlüsselweite im Vergleich von Verschraubungen mit zylindrischen Gewinden - geringerer Lochabstand; • Ermöglicht den Einsatz in verschiedene Gewindearten, sowie in konische- und zylindrische Innengewinde. 	DE
"UNIVERSAL SHORT" Le filetage conique "UNIVERSAL SHORT" a été conçu pour satisfaire les exigences suivantes: <ul style="list-style-type: none"> • réduire la longueur d'encombrement; • réduire les dimensions hexagonales par rapport au filetage cylindrique; • permettre le montage avec divers taraudages standards soit coniques soit cylindriques. 	FR	"UNIVERSAL SHORT" La rosca cónica "UNIVERSAL SHORT" ha sido proyectada para satisfacer las siguientes características: <ul style="list-style-type: none"> • reducir la longitud; • reducir la llave respecto a algunos racores con rosca cilíndrica; • consentir el acoplamiento con diferentes standard de roscas hembra sean cónicas o cilíndricas. 	ES	"UNIVERSAL SHORT" A rosca cónica "UNIVERSAL SHORT" é projetada para satisfazer às seguintes características: <ul style="list-style-type: none"> • reduzir o comprimento da conexão; • reduzir o dimensional com relação às roscas paralelas; • permitir o acoplamento da conexão a diferentes tipos de rosca fêmea, sejam elas cónicas ou paralelas. 	PT



Consentire una completa tenuta anche su superfici non perfettamente piane, concave, convesse o inclinate, con diversi smussi o raggi.	IT	To ensure the right tightening also with surfaces not perfectly flat, without spot-facing, concave convex and with different kinds of chamfers or radius.	GB	Eine vollständige Abdichtung ist auch auf unebenen Flächen, wie geneigt, konkav oder konvex und mit unterschiedlichen Radien oder Fasen gewährleistet.	DE
Pour permettre une parfaite étanchéité même sur des surfaces non planes, concaves, convexas ou inclinées et avec différents chanfreins ou rayons.	FR	Consentir una completa estanqueidad incluso en superficies no perfectamente planas, cóncavas, convexas o inclinadas, con diferentes ángulos o radios.	ES	Permite um aperto correto em superfícies não perfeitamente planas, côncavas, convexas ou inclinadas, com diferentes chanfros ou raios.	PT



Coppia di serraggio

Torque specifications

Angaben Drehmoment

Couple de serrage

Par de apriete

Especificações de Torque



ISO 228

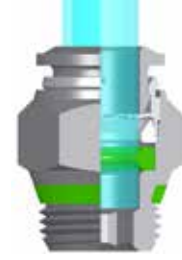

"UNIVERSAL SHORT"

I valori di rottura possono variare in base all'articolo
 Breaking values may vary according to the item
 Die maximal werte dienen nur zu Informationszwecken
 Les valeurs maximales sont présentées à titre indicatif
 Los valores de rotura pueden variar en función del artículo
 Os valores de ruptura podem variar em função do item

MISURA MEASURE GRÖSSE DIMENSIONS MEDIDA MEDIDA	COPPIA CONSIGLIATA Nm RECOMMENDED TORQUE Nm EMPFOHLENES DREHMOMENT Nm COUPLE DE SERRAGE Nm PAR ACONSEJADO Nm TORQUE RECOMENDADO Nm	COPPIA DI ROTTURA Nm BREAKING TORQUE Nm ABSCHERDREHMOMENT Nm COUPLE DE RUPTURE Nm PAR DE ROTURA Nm TORQUE DE RUPTURA Nm
M5	0,8	3,2
M7	3	8
M8	3	8
1/8	3	8
1/4	9	30
3/8	10	60
1/2	12	50

MISURA MEASURE GRÖSSE DIMENSIONS MEDIDA MEDIDA	COPPIA MINIMA CONSIGLIATA Nm RECOMMENDED MINIMUM TORQUE Nm EMPFOHLENES DREHMOMENT Nm COUPLE DE SERRAGE Nm PAR MÍNIMO ACONSEJADO Nm TORQUE MÍNIMO RECOMENDADO Nm	COPPIA MASSIMA CONSIGLIATA Nm RECOMMENDED MAX TORQUE Nm ABSCHERDREHMOMENT Nm COUPLE DE RUPTURE Nm PAR MÁXIMO ACONSEJADO Nm TORQUE MÁXIMA RECOMENDADO Nm
1/8	5	7
1/4	5	7
3/8	5	7
1/2	5	7

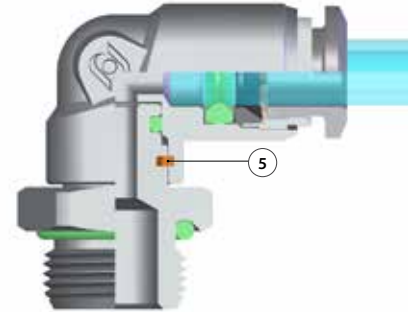
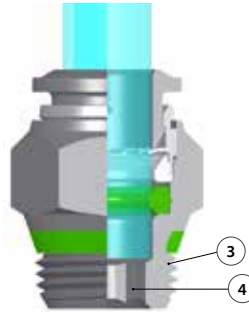
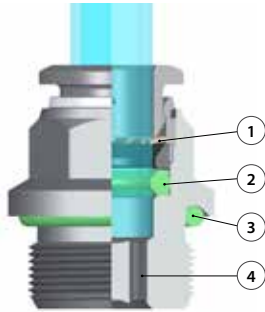

Vantaggi

IT

- 1 La pinza in acciaio inox garantisce il perfetto aggraffaggio di tubi di qualsiasi materiale senza danneggiarne la superficie. Il collegamento tra tubo e raccordo assicura una tenuta totale anche in condizioni di urti e vibrazioni.
- 2 La particolare geometria della guarnizione permette inoltre l'utilizzo dei raccordi anche con il vuoto.
- 3 Tutte le filettature di questa serie sono state dotate di elementi di tenuta che permettono l'immediato utilizzo dei raccordi riducendo notevolmente i tempi di installazione.
- 4 Tutti i raccordi dritti possono essere montati anche con chiave esagonale ed è possibile utilizzarli anche in spazi molto ridotti.
- 5 Raccordo orientabile con anello di sicurezza interno. Garantisce maggiore durata alla rotazione e trazione.

Advantages

GB

- 1 The washer is made in stainless steel ensures the perfect tube clamping with every kinds of materials without damage the surface. The connection between the tube and the fitting ensure a total tightness even in severe conditions such as impact and vibrations.
- 2 The particular geometric shape of the seal ensure the perfect tightness even with vacuum.
- 3 All of threads from this range have been equipped with tightening parts which allow the direct assembly of the fittings, reducing the installation time.
- 4 All the straight fittings can be assembled also with Allen wrench and it is possible to use them in reduced spaces.
- 5 Orienting fitting with safety ring inside. Improved durability to the rotation and traction.

Vorteile

DE

- 1 Konisches Gewinde "kurz" Die Zahnscheibe sorgt für eine perfekte Halterung des Rohres ohne die Oberfläche zu beschädigen. Die Dichtheit zwischen Rohr und Verschraubung ist auch bei Erschütterungen und Vibrationen gewährleistet.
- 2 Die besondere Geometrie der Dichtung ermöglicht auch die Anwendung der Verschraubungen in Verbindung mit Vakuum.
- 3 Alle Verschraubungen in dieser Serie sind mit Gewindeabdichtungen ausgestattet, die den sofortigen Einsatz ermöglichen und daher die Montagezeit stark reduzieren.
- 4 Alle geraden Verschraubungen können auch mit Inbusschlüsseln montiert werden, daher kleiner Lochabstand möglich.
- 5 Flexible Montage mit Sicherungsring innen. Verbesserte Beständigkeit gegenüber der Drehung und Traktions.

Avantages

FR

- 1 La rondelle en acier inoxydable garantit la parfaite tenue du tube quelle que soit la matière et sans l'endommager. La connexion entre le tube et le raccord assure une étanchéité totale même dans des conditions d'impact ou de vibrations.
- 2 La spécificité géométrique du joint permet l'utilisation des raccords avec le vide.
- 3 Tous les filetages de cette série sont équipés d'éléments d'étanchéité qui permettent l'utilisation immédiate des raccords réduisant ainsi le temps d'installation.
- 4 Tous les raccords droits peuvent être aussi montés avec une clé hexagonale pour permettre une utilisation dans des espaces réduits.
- 5 Accessoire de fixation réglable avec anneau de sécurité à l'intérieur. Amélioration de la durée de la rotation et de traction.

Ventajas

ES

- 1 La pinza en acero inoxidable garantiza el perfecto agarre del tubo de cualquier material sin perjudicar la superficie. La conexión entre tubo y racor asegura una estanqueidad total aun en condiciones de impacto o vibración.
- 2 La particular geometría de la junta garantiza una perfecta estanqueidad incluso en vacío.
- 3 Todas las roscas de esta serie están fabricadas con junta de cierre que permite la inmediata utilización del racor reduciendo notablemente el tiempo de instalación.
- 4 Todos los racores rectos pueden montarse también con llave hexagonal y es posible utilizarlos incluso en espacios muy reducidos.
- 5 Montaje ajustable con sistema de seguridad interior. La mejora de la durabilidad a la rotación y tracción.

Vantagens

PT

- 1 A pinça em aço-inox garante o perfeito travamento do tubo de qualquer material sem danificar a superfície do mesmo. A conexão entre o tubo e a conexão assegura uma vedação total também em condições de impactos e vibrações.
- 2 A geometria particular da vedação permite a utilização da conexão também para aplicações com vácuo.
- 3 Todas as roscas desta série são dotadas de elementos de vedação, o que permite a imediata utilização das conexões, reduzindo notavelmente o tempo de instalação.
- 4 Todas as conexões retas podem ser montadas também com chave allenando possível montagem das mesmas em espaços bem reduzidos.
- 5 Montagem ajustável com anel de segurança dentro. A durabilidade melhorada para a rotação e tração.

40005V

RACCORDO DIRITTO MASCHIO "UNIVERSAL SHORT"

STRAIGHT MALE ADAPTOR "UNIVERSAL SHORT"

GERADE EINSCHRAUBVERSCHRAUBUNG KONISCH "UNIVERSAL SHORT"

RACCORD DROIT MÂLE, CONIQUE "UNIVERSAL SHORT"

RACOR RECTO MACHO CÓNICO "UNIVERSAL SHORT"

CONEXÃO RETA COM ROSCA "UNIVERSAL SHORT"

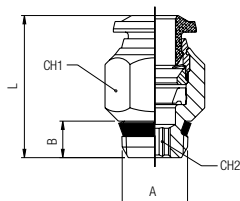

Code	Tube	A	B	L	CH1	CH2	Pack.
40005 V0 002	6	1/8	5.5	21.5	13	4	10
40005 V0 004	8	1/8	5.5	24.5	14	5	10
40005 V0 005	8	1/4	7	22	14	6	10
40005 V0 007	10	1/4	7	28	17	7	10
40005 V0 017	10	1/2	9	26	21	8	10
40005 V0 009	12	1/4	7	31.5	20	7	10
40005 V0 010	12	3/8	7.5	29.5	20	9	10

40010V

RACCORDO DIRITTO MASCHIO CILINDRICO ESAGONO INCASSATO

STRAIGHT MALE ADAPTOR (PARALLEL) WITH HEXAGON EMBEDDED

GERADE EINSCHRAUBVERSCHRAUBUNG MIT INNENSECHSKANT ZYLINDRISCH

RACCORD DROIT MÂLE, CYLINDRIQUE, 6-PANS INTERIEUR

RACOR RECTO MACHO CILÍNDRICO HEXÁGONO INTERIOR

CONEXÃO RETA COM SEXTAVADO INTERNO E ROSCA MÉTRICA

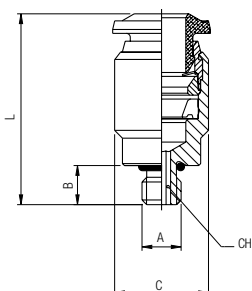

Code	Tube	A	B	C	L	CH	Pack.
40010 V0 001	4	M5	3.6	10	21	2.5	10
40010 V0 007	6	M5	3.6	12	24.5	2.5	10

40020V

RACCORDO DIRITTO MASCHIO CILINDRICO

STRAIGHT MALE ADAPTOR (PARALLEL)

GERADE EINSCHRAUBVERSCHRAUBUNG ZYLINDRISCH

RACCORD DROIT MÂLE, CYLINDRIQUE

RACOR RECTO MACHO CILÍNDRICO CON TÓRICA

CONEXÃO RETA COM ROSCA PARALELA

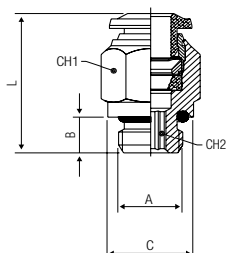

Code	Tube	A	B	C	L	CH1	CH2	Pack.
40020 V0 001	4	M5	3.6	8	20	10	2	10
40020 V0 037	4	M6X1	3.6	10	20	10	2.5	10
40020 V0 033	4	M8X1	5.4	12	18.5	10	3	10
40020 V0 002	4	1/8	5.4	13	20	10	3	10
40020 V0 022	4	1/4	7.1	16	19.5	16	3	10
40020 V0 020	6	M5	3.6	10	26.5	13	2	10
40020 V0 003	6	1/8	5.4	13	23.5	13	4	10
40020 V0 004	6	1/4	7.1	16	23.5	13	4	10
40020 V0 027	6	3/8	8.1	20	25	13	4	10
40020 V0 028	6	1/2	9.6	25	27	13	4	10
40020 V0 005	8	1/8	5.4	13	25	14	5	10
40020 V0 006	8	1/4	7.1	16	23	14	6	10
40020 V0 007	8	3/8	8.1	20	24	14	6	10
40020 V0 029	8	1/2	9.6	25	26.5	14	6	10
40020 V0 008	10	1/4	7.1	16	30.5	17	6	10
40020 V0 009	10	3/8	8.1	20	27.5	17	8	10
40020 V0 031	10	1/2	9.6	25	27	17	8	10
40020 V0 032	12	1/4	7.1	16	34.5	20	6	10
40020 V0 011	12	3/8	8.1	20	34	20	8	10
40020 V0 023	12	1/2	9.6	25	31	22	10	10
40020 V0 024	14	3/8	8.1	20	35	21	10	10
40020 V0 025	14	1/2	9.6	25	32	22	11	10

40030V

RACCORDO DIRITTO FEMMINA

STRAIGHT FEMALE ADAPTOR
 AUFSCHRAUBVERSCHRAUBUNG
 RACCORD DROIT, TARAUDE
 RACOR RECTO HEMBRA
 CONEXÃO RETA COM ROSCA FÊMEA

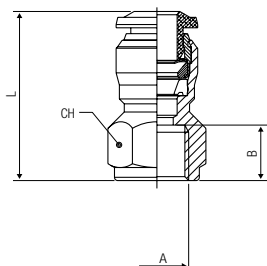

Code	Tube	A	B	L	CH	Pack.
40030 V0 008	4	M5	5.5	21	11	10
40030 V0 001	4	1/8	8.5	24	13	10
40030 V0 009	4	1/4	11	27.5	16	10
40030 V0 002	6	1/8	8.5	26	13	10
40030 V0 007	6	1/4	11	29.5	16	10
40030 V0 004	8	1/8	8.5	27	15	10
40030 V0 005	8	1/4	11	29.5	17	10
40030 V0 010	8	3/8	12	32	19	10
40030 V0 011	10	1/4	11	32	18	10
40030 V0 012	10	3/8	12	33.5	19	10
40030 V0 013	10	1/2	15	39	24	10
40030 V0 014	12	3/8	12	36	21	10
40030 V0 015	12	1/2	15	41	24	10

40040V

RACCORDO DIRITTO INTERMEDIO

STRAIGHT CONNECTOR
 VERBINDUNGSVERSCHRAUBUNG
 RACCORD UNION DOUBLE
 RACOR RECTO INTERMEDIO
 CONEXÃO RETA TUBO-TUBO

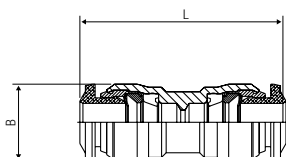

Code	Tube	Tube	L	B	Pack.
40040 V0 001	4 (5/32)	4 (5/32)	30.5	10.5	10
40040 V0 002	6	4	32	12.5	10
40040 V0 003	6	6	34	12.5	10
40040 V0 004	8	6	35	14.5	10
40040 V0 005	8 (5/16)	8 (5/16)	36	14.5	10
40040 V0 011	10	8	40.5	17.5	10
40040 V0 006	10	10	42	17.5	10
40040 V0 012	12	10	45.5	20.5	10
40040 V0 007	12	12	47	20.5	10
40040 V0 010	14	14	49	21.5	10

40050V

RACCORDO DIRITTO INTERMEDIO DI ATTRAVERSAMENTO

BULKHEAD CONNECTOR
 SCHOTTVERSCHRAUBUNG
 RACCORD TRAVERSÉE DE CLOISON
 RACOR RECTO INTERMEDIO PASATABIQUES
 CONEXÃO PASSA-MURO RETA TUBO-TUBO

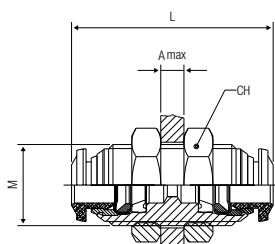

Code	Tube	M	L	CH	Amax	Pack.
40050 V0 001	4 (5/32)	M12x1	31.5	17	7	10
40050 V0 002	6	M14x1	35	17	9.5	10
40050 V0 009	8(5/16)-6	M16x1	37	19	10.5	10
40050 V0 003	8(5/16)	M16x1	37	19	10.5	10
40050 V0 010	10-6	M20x1	43	24	11.5	10
40050 V0 011	10-8	M20x1	43	24	12.5	10
40050 V0 004	10	M20x1	43	24	12.5	10
40050 V0 005	12	M22x1	48	26	16.5	10

40060V

RACCORDO A L ORIENTABILE INTERMEDIO DI ATTRAVERSAMENTO

BULKHEAD ORIENTING ELBOW

WINKEL-SCHOTTVERSCHRAUBUNG (DREHBAR)

RACCORD EQUERRE ORIENTABLE A TRAVERSEE DE CLOISON

RACOR A L ORIENTABLE INTERMEDIO PASATABIQUES

CONEXÃO PASSA-MURO EM "L" ORIENTÁVEL

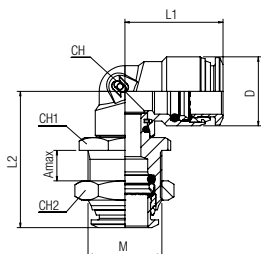

Code	Tube	M	L1	L2	D	CH	CH1	CH2	Amax	Pack.
40060 V0 003	4	M12x1	17.5	26	10	9	14	17	6	10
40060 V0 004	6	M14x1	21.5	31	12.5	11	16	17	6.5	10
40060 V0 005	8	M16x1	22	34	14.5	12	18	19	6.5	10
40060 V0 006	10	M20x1	26.5	36	17.5	14	22	24	7.5	10
40060 V0 007	12	M22x1	30.5	43	21.5	16	24	26	9	10
40060 V0 008	14	M23x1	30.5	43	21.5	16	25	27	9.5	10

40106V

RACCORDO A L ORIENTABILE FEMMINA

ORIENTING ELBOW FEMALE ADAPTOR

AUFSCRAUB-WINKELSCHRAUBUNG (DREHBAR)

RACCORD EQUERRE ORIENTABLE TARAUDE

RACOR A L ORIENTABLE HEMBRA

CONEXÃO EM "L" ORIENTÁVEL COM ROSCA FÊMEA

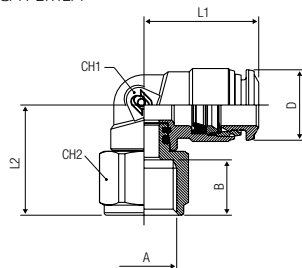

Code	Tube	A	B	L1	L2	CH1	CH2	D	Pack.
40106 V0 001	4	1/8	8.5	18	20	9	13	10	10
40106 V0 002	4	1/4	11	18	21.5	9	16	10	10
40106 V0 003	6	1/8	8.5	21	20.5	11	13	12.5	10
40106 V0 004	6	1/4	11	21	23	11	16	12.5	10
40106 V0 005	8	1/8	8.5	22.5	20.5	12	13	14.5	10
40106 V0 006	8	1/4	11	22.5	23	12	16	14.5	10

40111V

RACCORDO A L ORIENTABILE MASCHIO "UNIVERSAL SHORT"

ORIENTING ELBOW MALE ADAPTOR "UNIVERSAL SHORT"

WINKELVERSCHRAUBUNG KONISCH (DREHBAR) "UNIVERSAL SHORT"

EQUERRE ORIENTABLE MÂLE, CONIQUE "UNIVERSAL SHORT"

RACOR A L ORIENTABLE MACHO "UNIVERSAL SHORT"

CONEXÃO MACHO EM "L" ORIENTÁVEL COM ROSCA "UNIVERSAL SHORT"

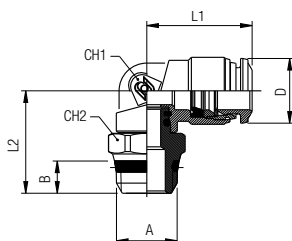

Code	Tube	A	B	L1	L2	CH1	CH2	D	Pack.
40111 V0 003	4	1/8	5.5	18	19.5	9	13	10	10
40111 V0 002	4	1/4	7	18	21	9	15	10	10
40111 V0 004	6	1/8	5.5	21	21.5	11	13	12.5	10
40111 V0 005	6	1/4	7	21	23	11	15	12.5	10
40111 V0 006	8	1/8	5.5	22.5	22.5	12	13	14.5	10
40111 V0 007	8	1/4	7	22.5	22.5	12	15	14.5	10
40111 V0 008	8	3/8	7.5	22.5	23	12	17	14.5	10
40111 V0 009	8	1/2	9	22.5	25.5	12	21	14.5	10
40111 V0 010	10	1/4	7	26.5	26.5	14	16	17.5	10
40111 V0 011	10	3/8	7.5	26.5	24.5	14	17	17.5	10
40111 V0 012	10	1/2	9	26.5	27	14	21	17.5	10
40111 V0 013	12	3/8	7.5	31.5	26.5	16	20	21.5	10
40111 V0 014	12	1/2	9	31.5	29	16	21	21.5	10
40111 V0 015	14	3/8	7.5	31.5	27	16	20	21.5	10
40111 V0 016	14	1/2	9	31.5	29.5	16	21	21.5	10

40116V

RACCORDO A L ORIENTABILE MASCHIO CILINDRICO

ORIENTING ELBOW MALE ADAPTOR (PARALLEL)

WINKELVERSCHRAUBUNG ZYLINDRISCH (DREHBAR)

EQUERRE ORIENTABLE MÂLE, CYLINDRIQUE

RACOR A L ORIENTABLE MACHO CILÍNDRICO CON TÓRICA

CONEXÃO MACHO EM "L" ORIENTÁVEL COM ROSCA PARALELA

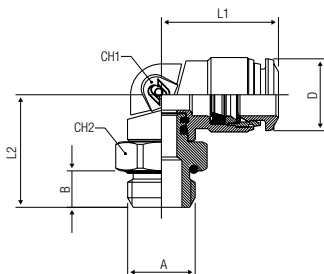

Code	Tube	A	B	L1	L2	CH1	CH2	D	Pack.
40116 V0 002	4	M5	3.6	17.5	18	9	8	10	10
40116 V0 026	4	M6X1	3.6	17.5	18	9	8	10	10
40116 V0 027	4	M8X1	5.4	17.5	18	9	12	10	10
40116 V0 003	4	1/8	5.4	18	18	9	13	10	10
40116 V0 004	4	1/4	7.1	18	18	9	16	10	10
40116 V0 007	6	M5	3.6	21	20	11	11	12.5	10
40116 V0 028	6	M10X1	5.4	21	20	11	13	12.5	10
40116 V0 008	6	1/8	5.4	21	20	11	13	12.5	10
40116 V0 009	6	1/4	7.1	21	21.5	11	16	12.5	10
40116 V0 010	8	1/8	5.4	22.5	21	12	13	14.5	10
40116 V0 011	8	1/4	7.1	22.5	21.5	12	16	14.5	10
40116 V0 012	8	3/8	8.1	22.5	23.5	12	20	14.5	10
40116 V0 013	8	1/2	9.6	22.5	25	12	25	14.5	10
40116 V0 014	10	1/4	7.1	26.5	25.5	14	16	17.5	10
40116 V0 015	10	3/8	8.1	26.5	25	14	20	17.5	10
40116 V0 016	10	1/2	9.6	26.5	26.5	14	25	17.5	10
40116 V0 025	12	1/4	7.1	31.5	27.5	16	20	21.5	10
40116 V0 017	12	3/8	8.1	30.5	28.5	16	20	21.5	10
40116 V0 018	12	1/2	9.6	30.5	30	16	25	21.5	10
40116 V0 019	14	3/8	8.1	30.5	35.5	19	20	21.5	10
40116 V0 020	14	1/2	9.6	30.5	35.5	19	25	21.5	10

40126V

RACCORDO A L ORIENTABILE PROLUNGATO MASCHIO CILINDRICO

EXTENDED ORIENTING ELBOW MALE ADAPTOR (PARALLEL)

VERLÄNGERTE WINKELVERSCHRAUBUNG ZYLINDRISCH (DREHBAR)

EQUERRE PROLONGÉE ORIENTABLE MÂLE, CYLINDRIQUE

RACOR A L ORIENTABLE PROLONGADO MACHO CILÍNDRICO CON TÓRICA

CONEXÃO MACHO EM "L" PROLONGADO COM ROSCA PARALELA

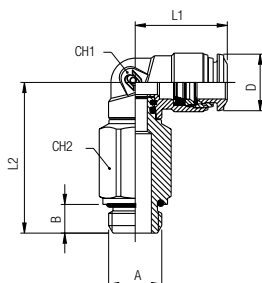

Code	Tube	A	B	L1	L2	CH1	CH2	D	Pack.
40126 V0 004	6	1/8	5.4	21	34.5	11	12	12.5	10
40126 V0 006	8	1/8	5.4	22.8	37.5	12	12	14.5	10
40126 V0 007	8	1/4	7.1	22.5	38	12	15	14.5	10
40126 V0 009	10	1/4	7.1	26.5	45	14	16	17.5	10

40130V

RACCORDO A L INTERMEDIO

ELBOW CONNECTOR

WINKELVERSCHRAUBUNG

RACCORD EQUERRE

RACOR A L INTERMEDIO

CONEXÃO EM "L" TUBO-TUBO

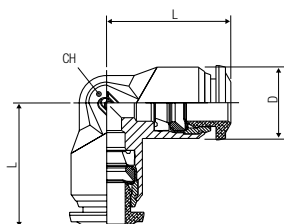

Code	Tube	L	CH	D	Pack.
40130 V0 001	4 (5/32)	17	9	10	10
40130 V0 002	6	21	11	12.5	10
40130 V0 003	8 (5/16)	22.5	13	14	10
40130 V0 004	10	26.5	16	17	10
40130 V0 005	12	30.5	19	21.5	10
40130 V0 008	14	32.5	19	21.5	10

40216V

RACCORDO A T ORIENTABILE MASCHIO CILINDRICO

ORIENTING TEE MALE ADAPTOR (PARALLEL) CENTRE LEG
 T-EINSCHRAUBVERSCHRAUBUNG ZYLINDRISCH (DREHBAR)
 TÉ ORIENTABLE À PIQUAGE MÂLE CENTRAL, CYLINDRIQUE
 RACOR A T ORIENTABLE MACHO CENTRAL CILÍNDRICO CON TÓRICA
 CONEXÃO MACHO EM "T" ORIENTÁVEL COM ROSCA PARALELA

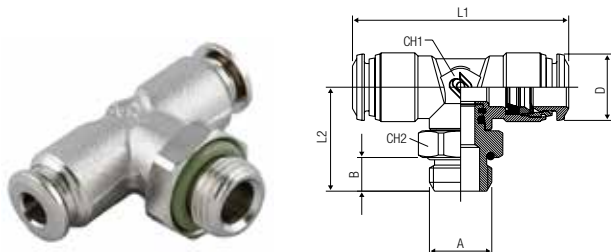

Code	Tube	A	B	L1	L2	CH1	CH2	D	Pack.
40216 V0 002	4	M5	3.6	34	18	9	8	10	10
40216 V0 003	4	1/8	5.4	34	18.5	9	13	10	10
40216 V0 004	4	1/4	7.1	34	20	9	16	10	10
40216 V0 007	6	M5	3.6	42	20.5	11	11	12.5	10
40216 V0 008	6	1/8	5.4	42	20.5	11	13	12.5	10
40216 V0 009	6	1/4	7.1	42	22	11	16	12.5	10
40216 V0 010	8	1/8	5.4	45	23.5	13	13	14.5	10
40216 V0 011	8	1/4	7.1	45	24	13	16	14.5	10
40216 V0 012	8	3/8	8.1	45	26	13	20	14.5	10
40216 V0 013	8	1/2	9.6	45	27.5	13	25	14.5	10
40216 V0 014	10	1/4	7.1	53	27.5	14	16	17.5	10
40216 V0 015	10	3/8	8.1	53	27	14	20	17.5	10
40216 V0 016	10	1/2	9.6	53	28.5	14	25	17.5	10
40216 V0 017	12	3/8	8.1	62.5	29.5	16	20	21.5	10
40216 V0 018	12	1/2	9.6	62.5	31	16	25	21.5	10
40216 V0 019	14	3/8	8.1	62.5	29.5	16	20	21.5	10
40216 V0 020	14	1/2	9.6	62.5	31	16	25	21.5	10

40226V

RACCORDO A T ORIENTABILE MASCHIO LATERALE CILINDRICO

ORIENTING TEE MALE ADAPTOR (PARALLEL) OFF - SET LEG
 L-EINSCHRAUBVERSCHRAUBUNG ZYLINDRISCH (DREHBAR)
 TÉ ORIENTABLE À PIQUAGE LATÉRAL, CYLINDRIQUE
 RACOR A T ORIENTABLE MACHO LATERAL CILÍNDRICO CON TÓRICA
 CONEXÃO MACHO EM "T" LATERAL ORIENTÁVEL COM ROSCA PARALELA

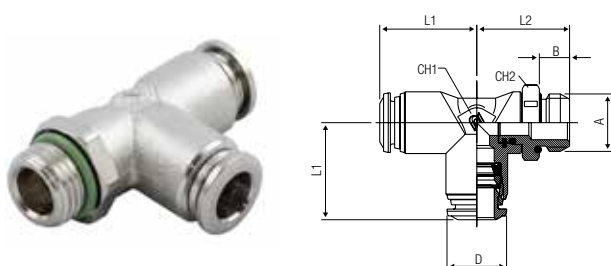

Code	Tube	A	B	L1	L2	CH1	CH2	D	Pack.
40226 V0 002	4	M5	3.6	17	18	9	8	10	10
40226 V0 003	4	1/8	5.4	17	18.5	9	13	10	10
40226 V0 004	4	1/4	7.1	17	20	9	16	10	10
40226 V0 007	6	M5	3.6	21	20.5	11	11	12.5	10
40226 V0 008	6	1/8	5.4	21	20.5	11	13	12.5	10
40226 V0 009	6	1/4	7.1	21	22	11	16	12.5	10
40226 V0 010	8	1/8	5.4	22.5	22.5	13	13	14.5	10
40226 V0 011	8	1/4	7.1	22.5	23	13	16	14.5	10
40226 V0 012	8	3/8	8.1	22.5	25	13	20	14.5	10
40226 V0 013	8	1/2	9.6	22.5	26.5	13	25	14.5	10
40226 V0 014	10	1/4	7.1	26.5	27	14	16	17.5	10
40226 V0 015	10	3/8	8.1	26.5	26.5	14	20	17.5	10
40226 V0 016	10	1/2	9.6	26.5	28	14	25	17.5	10
40226 V0 017	12	3/8	8.1	31.5	29.5	16	20	21.5	10
40226 V0 018	12	1/2	9.6	31.5	31	16	25	21.5	10

40230V

RACCORDO A T INTERMEDIO

TEE CONNECTOR
 T-ANSCHLUSS
 RACCORD TÉ
 RACOR A T INTERMEDIO
 CONEXÃO EM "T" TUBO-TUBO

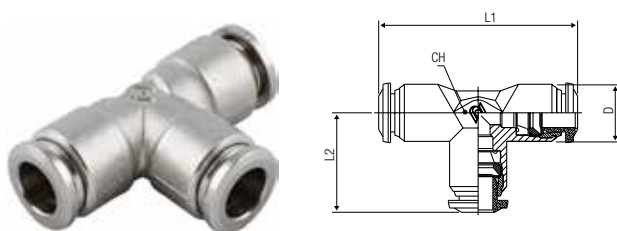

Code	Tube	L1	L2	CH	D	Pack.
40230 V0 001	4 (5/32)	34	17	9	10	10
40230 V0 002	6	42	21	11	12.5	10
40230 V0 003	8 (5/16)	45	22.5	13	14	10
40230 V0 004	10	53	26.5	16	17	10
40230 V0 005	12	61	30.5	19	21.5	10
40230 V0 008	14	65.5	32.5	19	21.5	10

40310V

RACCORDO A Y INTERMEDIO

Y CONNECTOR

Y-ANSCHLUSS

RACCORD Y SIMPLE

RACOR A Y INTERMEDIO

CONEXÃO EM "Y" TUBO-TUBO

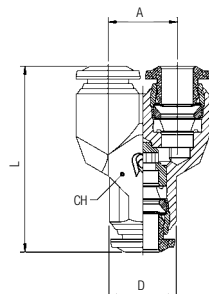

Code	Tube	A	L	CH	D	Pack.
40310 V0 001	4 (5/32)	11	32	11	10	10
40310 V0 002	6	13.5	36.5	13	12.5	10
40310 V0 003	8 (5/16)	15.5	41	15	14	10
40310 V0 008	10	18.5	48	18	17	10

40550V

RACCORDO A L ORIENTABILE MASCHIO CILINDRICO

ORIENTING SINGLE BANJO BODY MALE

WINKELVERSCHRAUBUNG ZYLINDRISCH (DREHBAR)

EQUERRE ORIENTABLE MÂLE, CYLINDRIQUE

RACOR A L ORIENTABLE MACHO CILÍNDRICO CON TÓRICA

CONEXÃO MACHO EM "L" ORIENTÁVEL COM ROSCA PARALELA

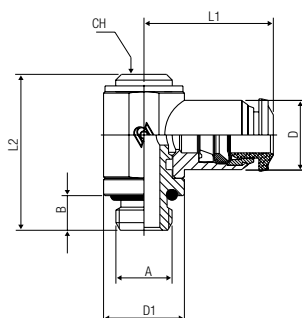

Code	Tube	A	B	L1	L2	CH	D1	D	Pack.
40550 V0 001	4	M5	3.6	19	24.5	-	9	10	10
40550 V0 002	4	1/8	5.4	21	28	5	14	10	10
40550 V0 015	6	M5	3.6	20.5	24.5	-	9	12.5	10
40550 V0 003	6	1/8	5.4	22.5	28	5	14	12.5	10
40550 V0 004	6	1/4	7.1	25	31	6	18	12.5	10
40550 V0 005	8	1/8	5.4	24	28	5	14	14	10
40550 V0 006	8	1/4	7.1	26	31	6	18	14	10
40550 V0 007	8	3/8	8.1	28	35.5	7	21	14	10
40550 V0 008	10	1/4	7.1	29	31	6	18	17	10
40550 V0 009	10	3/8	8.1	30.5	35.5	7	21	17	10
40550 V0 011	12	3/8	8.1	32.5	35.5	7	21	21.5	10

50600V

ADATTATORE MASCHIO CILINDRICO

MALE ADAPTOR PARALLEL

EINSCHRAUBSTECKVERSCHRAUBUNG ZYLINDRISCH

ADAPTATEUR ENCLIQUETABLE MÂLE, CYLINDRIQUE

ADAPTADOR MACHO CILÍNDRICO CON TÓRICA

ADAPTADOR MACHO COM ROSCA PARALELA

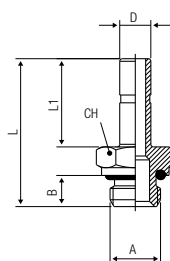

Code	D	A	B	L	L1	CH	Pack.
50600 V0 001	4	M5	3.6	24	15	8	10
50600 V0 002	4	1/8	5.4	26.5	15	13	10
50600 V0 015	6	M5	3.6	26	17	8	10
50600 V0 003	6	1/8	5.4	28.5	17	13	10
50600 V0 004	6	1/4	7.1	31	17	16	10
50600 V0 005	8	1/8	5.4	29.5	18	13	10
50600 V0 006	8	1/4	7.1	32	18	16	10
50600 V0 007	8	3/8	8.1	33.5	18	20	10
50600 V0 016	10	1/8	5.4	33.5	22	13	10
50600 V0 008	10	1/4	7.1	36	22	16	10
50600 V0 009	10	3/8	8.1	37.5	22	20	10
50600 V0 010	12	1/4	7.1	38.5	24.5	16	10
50600 V0 011	12	3/8	8.1	40	24.5	20	10
50600 V0 018	14	1/2	9.6	44	26.5	24	10

CH028

ADATTATORE MASCHIO CON ATTACCO PORTAGOMMA

MALE HOSE ADAPTER
 EINSTECK-SCHLAUCHTÜLLE
 DOUILLE CANNELEE ENCLIQUETABLE POUR TUYAU
 ADAPTADOR MACHO CON ESPIGA
 ADAPTADOR MACHO COM ESPIGÃO

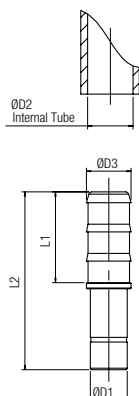

Code	D1	D3	D2	L1	L2	Pack.
CH028 00 01 FS NB	12	10	8	22.5	49	10
CH028 00 01 GP NB	8	10	8	22.5	42.5	10
CH028 00 01 GQ NB	12	14,5	12,5	29,5	56	10
CH028 00 01 WI NB	8	8,3	6,3	22,5	42,5	10
CH028 00 01 Y1 NB	12	12	10	27,5	56	10

50625

GIUNZIONE DOPPIA

DOUBLE JOINT
 DOPPELSTECKER
 JONCTION DOUBLE
 UNIÓN DOBLE
 JUNÇÃO DUPLA

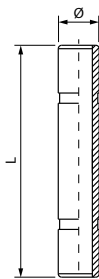

Code	Tube (Ø)	L	Pack.
50625 00 01 X1 NB	4	31	10
50625 00 01 X4 NB	6	34	10
50625 00 01 X7 NB	8	36	10
50625 00 01 X9 NB	10	45	10
50625 00 01 Y1 NB	12	50	10

40700V

RIDUZIONE

REDUCER
 REDUZIERUNG
 RÉDUCTION ENCLIQUETABLE
 REDUCCION
 REDUÇÃO

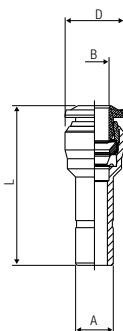

Code	A	B	L	D	Pack.
40700 V0 001	6	4	29,5	10,5	10
40700 V0 008	8	4	32	10,5	10
40700 V0 002	8	6	34	12,5	10
40700 V0 009	10	4	31	10,5	10
40700 V0 003	10	8	38	14,5	10
40700 V0 007	12	8	39	14,5	10
40700 V0 010	12	10	43	17,5	10

57610

TAPPO

PLUG
 VERSCHLUSSZAPFEN
 BOUCHON ENCLIQUETABLE
 TAPÓN
 TAMPÃO

Code	D	G	L	L1	Pack.
57610 00 01 X1 NB	4	8	25.5	18.5	10
57610 00 01 X4 NB	6	8	27.5	20.5	10
57610 00 01 X7 NB	8	12	29.5	21.5	10
57610 00 01 X9 NB	10	12	32.5	24.5	10
57610 00 01 Y1 NB	12	16	36.5	27.5	10
57610 00 01 Y3 NB	14	16	35.5	26.5	10

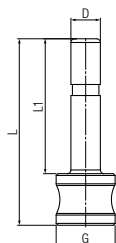

50980

CLIP DI SICUREZZA

SECURITY CLIPS
 SICHERHEITSClip
 CLIP DE SECURITÉ
 CLIP DE SEGURIDAD ROJO
 CLIP DE SEGURANÇA

Code	Tube	Pack.
50980 00 32 X1 RO	4-(5/32)	50
50980 00 32 X4 RO	6-(1/4)	50
50980 00 32 X7 RO	8-(5/16)	50
50980 00 32 X9 RO	10-(3/8)	50
50980 00 32 Y1 RO	12-(1/2)	50
50980 00 32 Y3 RO	14	50

