

AC-D Series Accessories (Spacer / Spacer with Bracket)

Spacer / Spacer with Bracket

Y **300** - D

① ②

	Symbol	Description	①				
			Body size [Applicable AC size]				
			200 [AC20]	300 [AC30]	400 [AC40]	500 [AC40-06]	600 [AC50/AC60]
② Bracket	—	Spacer	●	●	●	●	●
	T	Spacer with bracket	●	●	●	●	●

Spacer
(Y□-D)



Spacer with bracket
(Y□T-D)



Standard Specifications

Fluid	Air
Ambient and fluid temperatures	-5 to 60 °C (No freezing)
Proof pressure	1.5 MPa
Max. operating pressure	1.0 MPa

Replacement Parts

Description	Material	Part no.				
		Y200-D Y200T-D	Y300-D Y300T-D	Y400-D Y400T-D	Y500-D Y500T-D	Y600-D Y600T-D
Seal	HNBR	Y220P-050S	Y320P-050S	Y420P-050S	Y520P-050S	Y620P-050S

Dimensions

Spacer

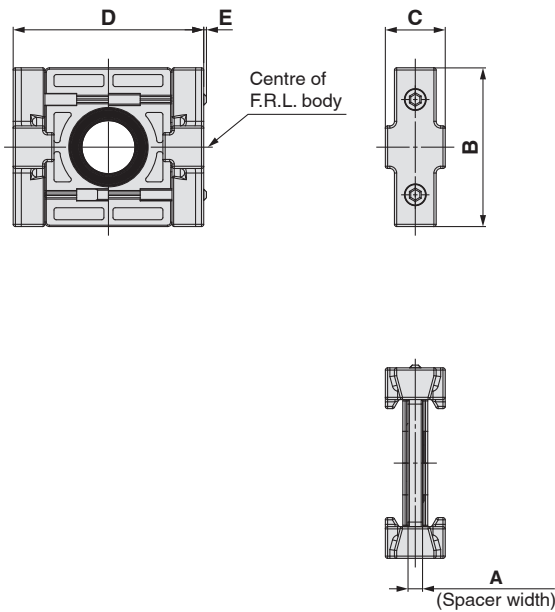

Spacer with bracket

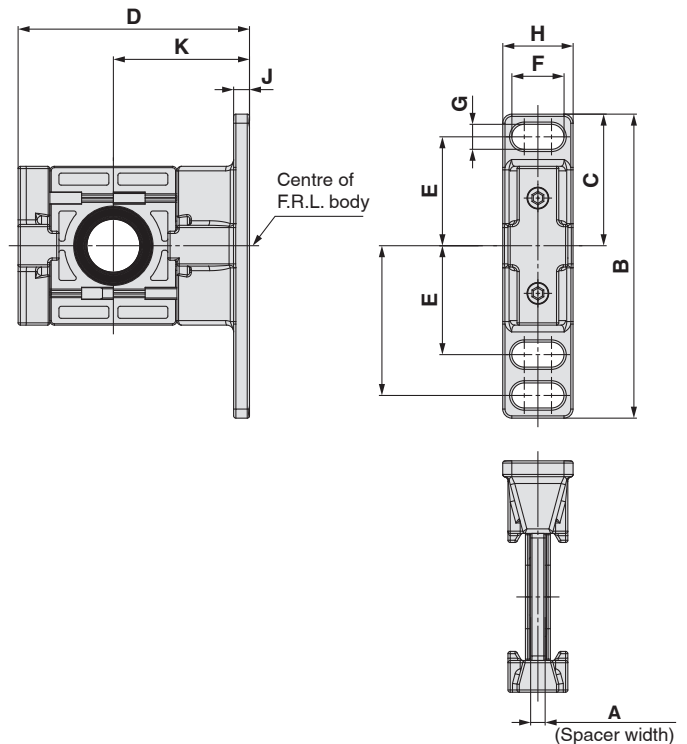

Model	A	B	C	D	E	L	Applicable size
Y200-D	3.2	35	13.2	42	0.6	2	AC20-D
Y300-D	4.2	43	16.2	53	—	3	AC30-D
Y400-D	5.2	51	19.2	71	—	3	AC40-D
Y500-D	5.2	54	21.2	71	—	3	AC40-06-D
Y600-D	6.2	64	27.2	90	—	4	AC50-D AC60-D

Model	A	B	C	D	E	EE	F	G	H	J	K	L	Applicable size
Y200T-D	3.2	67	29	51	24	33	11.5	5.5	15.5	3.5	30	2	AC20-D
Y300T-D	4.2	85	42.5	67.5	35	—	14	7	20	6	41	3	AC30-D
Y400T-D	5.2	115	50	85.5	40	55	18	9	26	7	50	3	AC40-D
Y500T-D	5.2	115	50	85.5	40	55	18	9	26	7	50	3	AC40-06-D
Y600T-D	6.2	140	60	115	50	70	20	11	31.2	8	70	4	AC50-D AC60-D

Modular F.R.L. Units

RoHS

Modular Design with Uniform Body Style

Better visibility & environmental resistance



The bowl is covered with a transparent bowl guard!

* Body sizes 30 and larger

- The inside is visible from 360°.
- The inner bowl is protected from the environment, allowing for improved safety.

- Inner bowl**
Material: Polycarbonate
- Transparent bowl guard**
Material: Polycarbonate



New A right angle square type pressure gauge and various attachments have been added.

Right Angle Square Type Pressure Gauge **p. 8**

Allows for pressure confirmation from the knob side

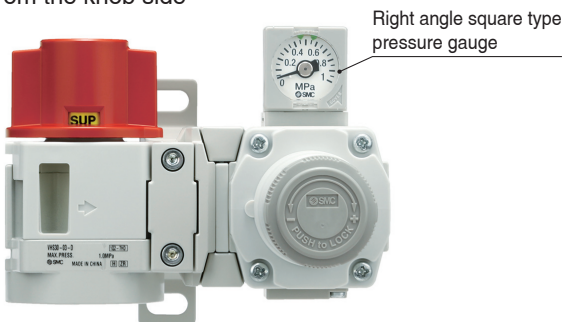

Cross Adapter **p. 9**

Allows for devices to be connected on the top, bottom, left, and right

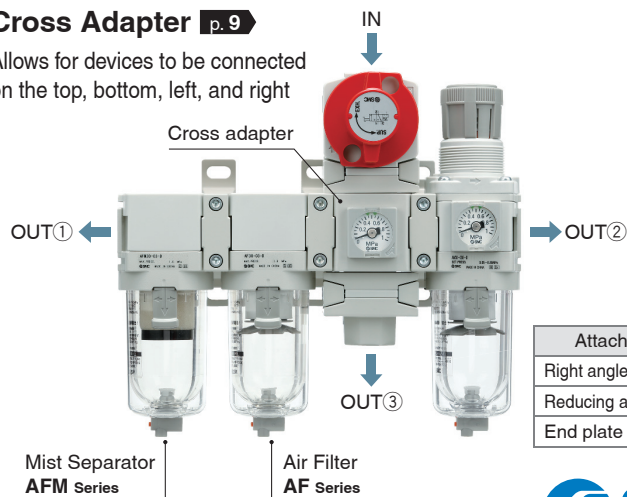

Attachment	Page
Right angle adapter	7
Reducing adapter	10
End plate	70

AC Series



CAT.EUS40-69D-UK

Transparent bowl guard

Better environmental resistance:

The transparent bowl guard protects the inner bowl!

The bowl guard with windows has been replaced with a **polycarbonate transparent bowl guard**. Now, even if the environment changes and the bowl is exposed to corrosive chemical or oil splash, **the foreign matter will not come into direct contact with the pressurized bowl**. This can reduce the risk of bowl breakage.

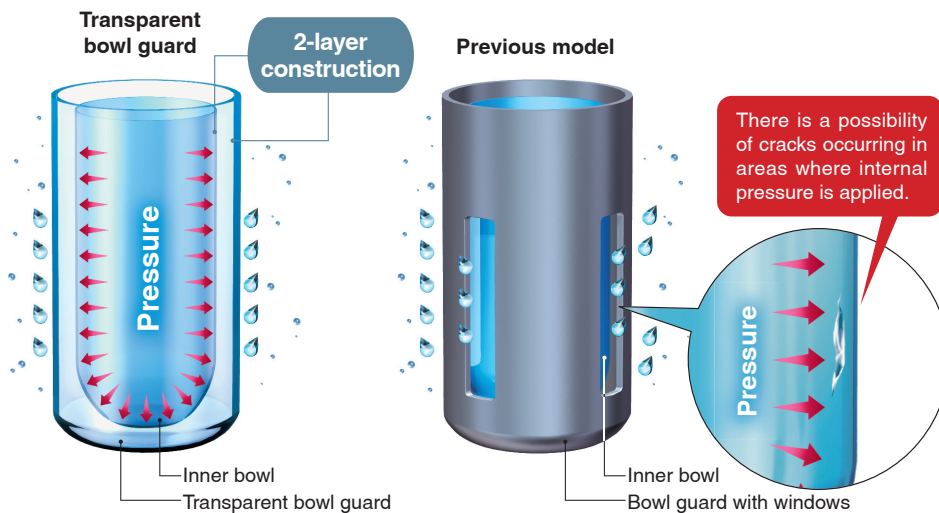

Better visibility: 360°

The transparent bowl guard allows for easy checking of the condensate level inside the filter bowl and the remaining oil amount in the lubricator from any direction.



Applicable model * Body sizes 30 and larger

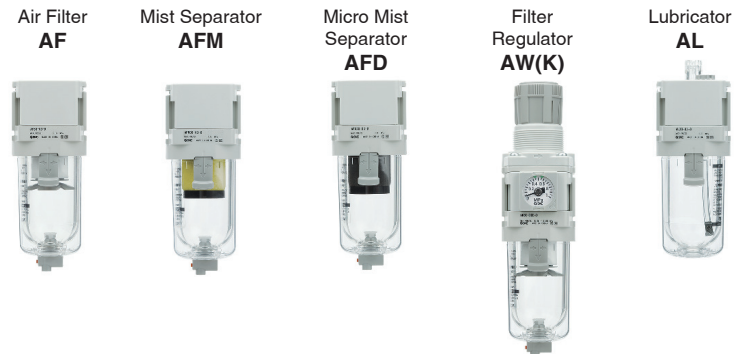

No tools are required.

Easier replacement of the element

* AF20-D to AF40-D only



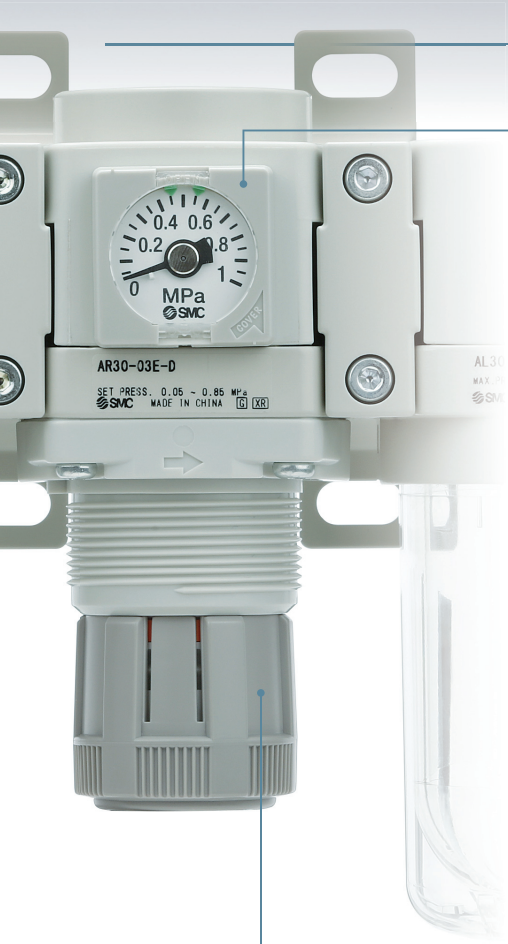

Selection of pressure gauges



(Right angle)
Square embedded
type pressure gauge



Round type
pressure gauge



Digital pressure switch

Open/close type gauge cover

- 1 Open the gauge cover.
- 2 Adjust the indicator to a specified position.
- 3 Close the gauge cover.

Open the gauge cover in the direction of the arrow with your fingertips.

Adjust the indicator using a flat blade screwdriver.

Close the gauge cover in the direction of the arrow and push it in until it clicks in place.

Easy to handle

Easy to hold when unlocked

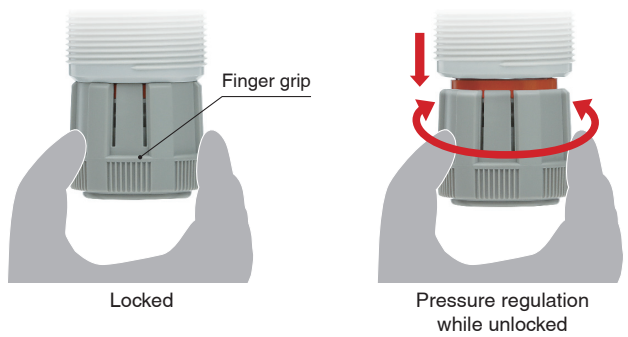

Mounting (Single unit)

The mounting pitch for panel mounting is interchangeable between the AR20(K)-D to AR40(K)-06-D and the AR(K)-B series and between the AW20(K)-D to AW40(K)-06-D and the AW(K)-B series. The brackets and set nuts are the same for both existing and new products.

Series	Body size					Details
	20	30	40	50	60	
AF						p. 75
AFM AFD						p. 86
AR(K)						p. 95
AW(K)						p. 116
AL						p. 107

Series Configuration

AC20 to AC60 Series

p. 17 Air Filter + Regulator + Lubricator
AF AR AL

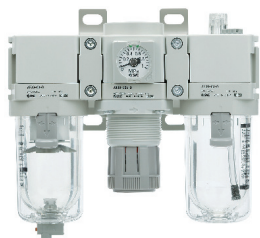

	Port size					
	1/8	1/4	3/8	1/2	3/4	1
Size 20	●	●				
Size 30		●	●			
Size 40		●	●	●		
Size 40-06					●	
Size 50					●	●
Size 60						●

AC20A to AC60A Series

p. 25 Filter Regulator + Lubricator
AW AL



	Port size					
	1/8	1/4	3/8	1/2	3/4	1
Size 20	●	●				
Size 30		●	●			
Size 40		●	●	●		
Size 40-06					●	
Size 50					●	●
Size 60						●

AC20B to AC60B Series

p. 31 Air Filter + Regulator
AF AR



	Port size					
	1/8	1/4	3/8	1/2	3/4	1
Size 20	●	●				
Size 30		●	●			
Size 40		●	●	●		
Size 40-06					●	
Size 50					●	●
Size 60						●

AC20C to AC40C Series

p. 39 Air Filter + Mist Separator + Regulator
AF AFM AR

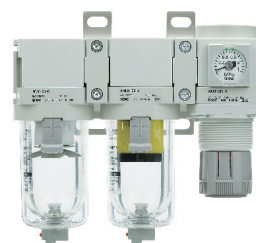

	Port size				
	1/8	1/4	3/8	1/2	3/4
Size 20	●	●			
Size 30		●	●		
Size 40		●	●	●	
Size 40-06					●

AC20D to AC40D Series

p. 47 Filter Regulator + Mist Separator
AW AFM



	Port size				
	1/8	1/4	3/8	1/2	3/4
Size 20	●	●			
Size 30		●	●		
Size 40		●	●	●	
Size 40-06					●

Table of Modular F.R.L. Unit Combinations for AC Assembly

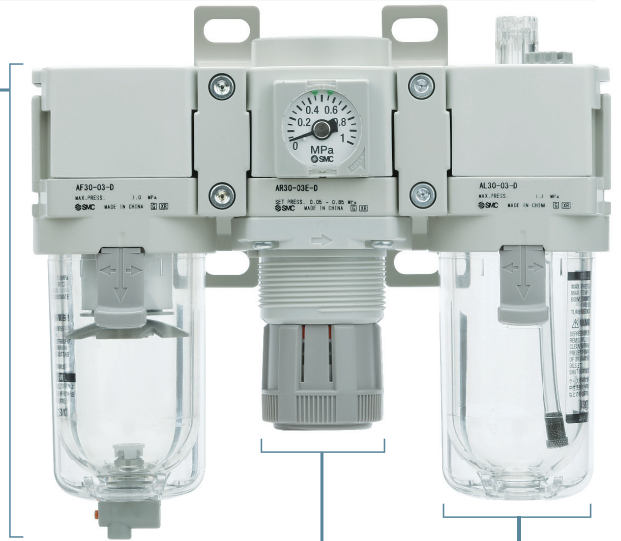

Air Filter
AF Series

p. 73



	Port size					
	1/8	1/4	3/8	1/2	3/4	1
Size 20	●	●				
Size 30		●	●			
Size 40		●	●	●		
Size 40-06					●	
Size 50					●	●
Size 60						●

Mist Separator
Micro Mist Separator
AFM/AFD Series

p. 84



	Port size				
	1/8	1/4	3/8	1/2	3/4
Size 20	●	●			
Size 30		●	●		
Size 40		●	●	●	
Size 40-06					●
Size 50					
Size 60					●

Regulator
AR Series

p. 92



	Port size					
	1/8	1/4	3/8	1/2	3/4	1
Size 20	●	●				
Size 30		●	●			
Size 40		●	●	●		
Size 40-06				●		
Size 50				●	●	
Size 60						●

Regulator with Backflow Function
AR□K Series

p. 92



	Port size					
	1/8	1/4	3/8	1/2	3/4	1
Size 20	●	●				
Size 30		●	●			
Size 40		●	●	●		
Size 40-06				●		
Size 50				●	●	
Size 60						●

Filter Regulator
AW Series

p. 112



	Port size					
	1/8	1/4	3/8	1/2	3/4	1
Size 20	●	●				
Size 30		●	●			
Size 40		●	●	●		
Size 40-06					●	
Size 50						●
Size 60						●

Filter Regulator with Backflow Function
AW□K Series

p. 112



	Port size					
	1/8	1/4	3/8	1/2	3/4	1
Size 20	●	●				
Size 30		●	●			
Size 40		●	●	●		
Size 40-06					●	
Size 50						●
Size 60						●

New Spacer p. 57



Interchangeable with the existing model

- The new spacer can be connected to the existing AF-A, AR-B, AL-A, and AW-B series.

Lubricator
AL Series

p. 105





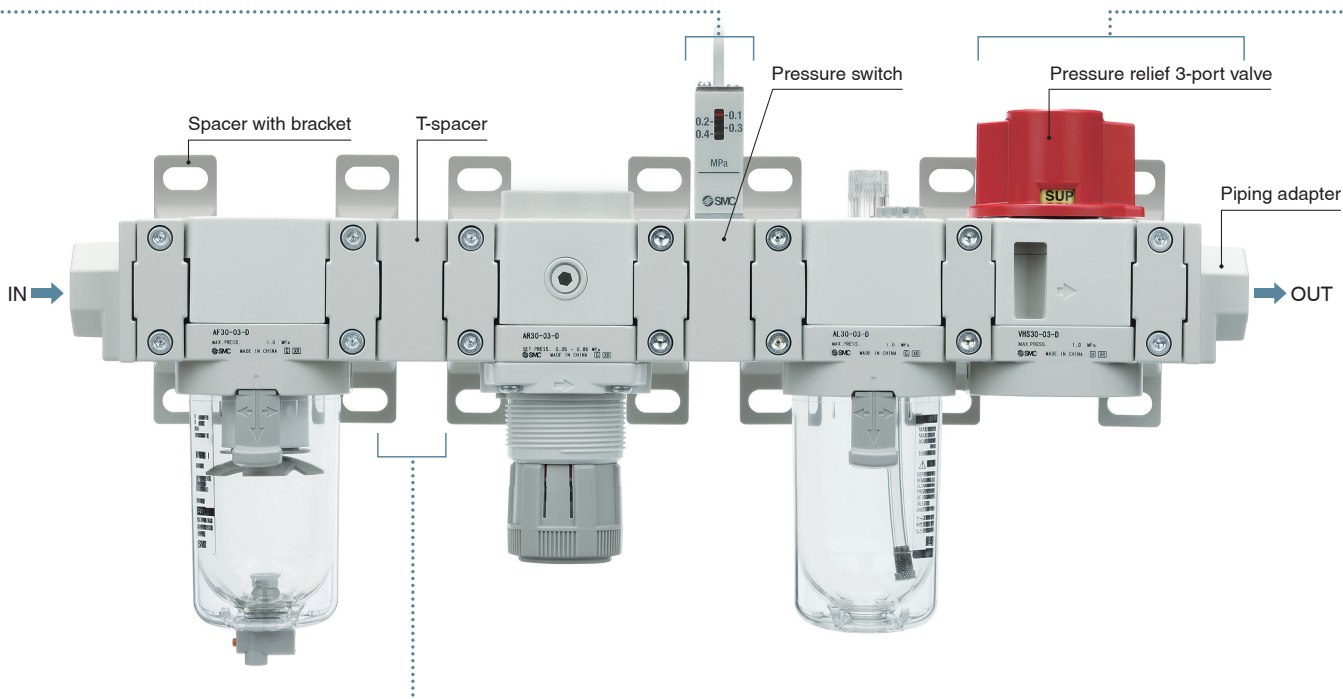

	Port size					
	1/8	1/4	3/8	1/2	3/4	1
Size 20	●	●				
Size 30		●	●			
Size 40		●	●	●		
Size 40-06					●	
Size 50					●	●
Size 60						●

Attachment List







Spacers

T-Spacer Y□10 Series	Cross Spacer Y□4 Series	Spacer Y□□ Series	Spacer with Bracket Y□□T Series
Piping in 2 directions is possible (upward or downward). p. 62	Piping in all 4 directions is possible. p. 63	p. 57	p. 57
 Slim type*1	 Front and back port selectable type*1		

*1 The mounting pitch is interchangeable with the existing attachment.







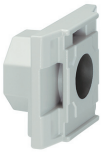

Pressure Switches

A compact, integrated pressure switch can be easily installed to facilitate the pressure detection of the line.

Pressure Switch with T-Spacer IS10T Series	Pressure Switch with L-Shaped Piping Adapter IS10L Series	Pressure Switch IS10M Series	Pressure Switch with Piping Adapter IS10E Series
The OUT side piping can be branched downward. p. 65	OUT side piping: Downward p. 66	p. 64	A piping adapter allows for the installation/removal of the component without removing the piping. p. 67
		 Slim type*1	

*1 The mounting pitch is interchangeable with the existing attachment.

Piping Adapters

<p>Piping Adapter E□00 Series</p> <p>A piping adapter allows for the installation/removal of the component without removing the piping.</p> <p>p. 59</p> 	<p>L-Shaped Piping Adapter E□00L Series</p> <p>Upward or downward piping is possible on the inlet side and the outlet side of F.R.L. units.</p> <p>p. 60</p> 	<p>T-Shaped Piping Adapter E□00T Series</p> <p>Both upward and downward piping are possible on the inlet and outlet sides of F.R.L. units.</p> <p>p. 61</p> 	<p>Pressure Relief 3-Port Valve VHS Series</p> <p>By using a pressure relief 3-port valve, pressure left in the line can be easily exhausted.</p> <p>p. 58</p> 
<p>New Right Angle Adapter E□10T Series</p> <p>Allows for modular connection with the product rotated 90 degrees</p> <p>p. 68</p> 	<p>New Reducing Adapter E□10R Series</p> <p>Allows for modular connection with products 1 body size larger or smaller</p> <p>p. 68</p> 	<p>New Cross Adapter Y□4M Series</p> <p>Allows for devices to be connected on the top, bottom, left, and right</p> <p>p. 69</p> 	<p>New End Plate E□00E Series</p> <p>For blocking the unused piping ports on sides without a modular connection</p> <p>p. 70</p> 

Space-saving design and reduced piping labour

Space-saving

Max. 16.4 %*1 reduction
Approx. 46 mm ← **Approx. 55 mm**
 *1 For size 30

Reduced piping labour

Number of screw-in connections
1 location ← **2 locations**

