

AC20A-D to AC60A-D

Symbol

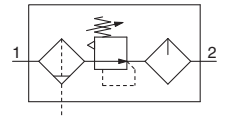

How to Order

AC **30** A- **03** **DE** - - - D

① ② ③ ④ ⑤ ⑥

Option and Semi-standard Symbol Selection

- Select one each for a to j.
- When more than one specification is required, indicate in alphanumeric order.
- Example) AC30A-F03DE1-16NR-D

	Symbol	Description	①							
			Body size							
			20	30	40	50	60			
②	—	Rc	●	●	●	●	●			
	N*1	NPT	●	●	●	●	●			
	F*2	G	●	●	●	●	●			
+										
③	01	1/8	●	—	—	—	—			
	02	1/4	●	●	●	—	—			
	03	3/8	—	●	●	—	—			
	04	1/2	—	—	●	—	—			
	06	3/4	—	—	●	●	—			
	10	1	—	—	—	●	●			
+										
④	a	—	Without auto drain		●	●	●	●	●	
		C*4	N.C. (Normally closed) Drain port is closed when pressure is not applied.		●	●	●	●	●	
		D*5	N.O. (Normally open) Drain port is open when pressure is not applied.		—	●	●	●	●	
	+									
	b	Pressure gauge*6	—	Without pressure gauge		●	●	●	●	●
			E	Square embedded type pressure gauge (with limit indicator)		●	●	●	●	●
			G	Round type pressure gauge (with limit indicator)		●	●	●	●	●
			M	Round type pressure gauge (with colour zone)		●	●	●	●	●
		Digital pressure switch	E1	Output: NPN output, Electrical entry: Wiring bottom entry		●	●	●	●	●
			E2	Output: NPN output, Electrical entry: Wiring top entry		●	●	●	●	●
			E3	Output: PNP output, Electrical entry: Wiring bottom entry		●	●	●	●	●
	E4	Output: PNP output, Electrical entry: Wiring top entry		●	●	●	●	●		
+										
⑤	c	—	Without attachment		●	●	●	●	●	
		V	Mounting position: AW + AL + V		●	●	●	●	—	
+										
⑥	d	—	0.05 to 0.85 MPa setting		●	●	●	●	●	
		1	0.02 to 0.2 MPa setting		●	●	●	●	●	
	+									
	e	Bowl*8	—	Polycarbonate bowl		●	●	●	●	●
			2	Metal bowl		●	●	●	●	●
			6	Nylon bowl		●	●	●	●	●
			8	Metal bowl with level gauge		—	●	●	●	●
			C	With bowl guard		●	—*9	—*9	—*9	—*9
			6C	With bowl guard (Nylon bowl)		●	—*10	—*10	—*10	—*10
	+									
	f	Filter regulator drain port*11	—	With drain cock		●	●	●	●	●
			J*12	Drain guide 1/8		●	—	—	—	—
			—	Drain guide 1/4		—	●	●	●	●
			W*13	Drain cock with barb fitting (for Ø 6 x Ø 4 nylon tube)		—	●	●	●	●
	+									
	g	Lubricator lubricant exhaust port	—	Without drain cock		●	●	●	●	●
			3*14	Lubricator with drain cock		●	●	●	●	●
	+									
	h	Exhaust mechanism	—	Relieving type		●	●	●	●	●
			N	Non-relieving type		●	●	●	●	●

Air Combination **AC20A-D to AC60A-D Series**

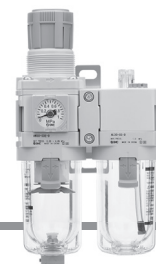

AC30A-D

		Symbol	Description	①				
				Body size				
				20	30	40	50	60
⑥	i	—	Flow direction: Left to right	●	●	●	●	●
		R	Flow direction: Right to left	●	●	●	●	●
	j	Unit	—	Unit on product label: MPa, °C, Pressure gauge in SI units: MPa	●	●	●	●
Z*15			Unit on product label: psi, °F, Pressure gauge: MPa/psi dual scale	○*17	○*17	○*17	○*17	○*17
ZA*16			Digital pressure switch: With unit selection function	△*18	△*18	△*18	△*18	△*18

- *1 Drain guide is NPT1/8 (applicable to the AC20A-D) and NPT1/4 (applicable to the AC30A-D to AC60A-D). The auto drain port comes with a $\text{O } 3/8$ " One-touch fitting (applicable to the AC30A-D to AC60A-D).
- *2 Drain guide is G1/8 (applicable to the AC20A-D) and G1/4 (applicable to the AC30A-D to AC60A-D).
- *3 Options G and M are not assembled and supplied loose at the time of shipment.
- *4 When pressure is not applied, condensate which does not start the auto drain mechanism will be left in the bowl. Releasing the residual condensate before ending operations for the day is recommended.
- *5 If the compressor is small (0.75 kW, discharge flow is less than 100 l/min (ANR)), air leakage from the drain cock may occur during the start of operations. N.C. type is recommended.
- *6 When the pressure gauge is attached, a 1.0 MPa pressure gauge will be fitted for standard (0.85 MPa) type. 0.4 MPa pressure gauge for 0.2 MPa type.
- *7 Pressure can be set higher than the specification pressure in some cases, but use pressure within the specification range.
- *8 Refer to chemical data on pages 111 and 129 for chemical resistance of the bowl.
- *9 A bowl guard is provided as standard equipment (polycarbonate).
- *10 A bowl guard is provided as standard equipment (nylon).
- *11 The combination of float type auto drain C and D is not available.
- *12 Without a valve function
- *13 The combination of metal bowl 2 and 8 is not available.
- *14 When choosing with W: Filter regulator drain port, the drain cock of a lubricator will be with barb fittings.
- *15 For the pipe thread type: NPT
This product is for overseas use only according to the New Measurement Act. (The SI unit type is provided for use in Japan.)
Cannot be used with M: Round type pressure gauge (with colour zone). Available by request for special. The digital pressure switch will be equipped with the unit selection function, setting to psi initially.
- *16 For options: E1, E2, E3, E4
This product is for overseas use only according to the New Measurement Act. (The SI unit is provided for use in Japan.)
- *17 ○: For the pipe thread type: NPT only
- *18 △: Select with options: E1, E2, E3, E4.

Standard Specifications

Model		AC20A-D	AC30A-D	AC40A-D	AC40A-06-D	AC50A-D	AC60A-D
Component	Filter Regulator [AW]	AW20-D	AW30-D	AW40-D	AW40-06-D	AW60-D	AW60-D
	Lubricator [AL]	AL20-D	AL30-D	AL40-D	AL40-06-D	AL50-D	AL60-D
Port size		1/8, 1/4	1/4, 3/8	1/4, 3/8, 1/2	3/4	3/4, 1	1
Pressure gauge port size*1 [AW]		1/8					
Fluid		Air					
Ambient and fluid temperatures*2		-5 to 60 °C (No freezing)					
Proof pressure		1.5 MPa					
Max. operating pressure		1.0 MPa					
Auto drain minimum operating pressure	N.C. [AW]	0.1 MPa	0.15 MPa				
	N.O. [AW]	—	0.1 MPa				
Set pressure range [AW]		0.05 to 0.85 MPa					
Nominal filtration rating*3 [AW]		5 μm					
Compressed air purity class*4		ISO 8573-1:2010 [6 : 4 : -]*5					
Drain capacity [AW]		8 cm ³	25 cm ³	45 cm ³			
Min. dripping flow rate*6 [AL]		15 l/min (ANR)	Port size 1/4: 30 l/min (ANR)	Port size 1/4: 30 l/min (ANR) Port size 3/8: 40 l/min (ANR) Port size 1/2: 50 l/min (ANR)	50 l/min (ANR)	190 l/min (ANR)	220 l/min (ANR)
			Port size 3/8: 40 l/min (ANR)				
Oil capacity [AL]		25 cm ³	55 cm ³	135 cm ³			
Recommended lubricant [AL]		Class 1 turbine oil (ISO VG32)					
Bowl material [AW/AL]		Polycarbonate					
Bowl guard [AW/AL]		Semi-standard (Steel)	Standard (Polycarbonate)				
Construction [AW]		Relieving type					
Weight		0.31 kg	0.58 kg	1.12 kg	1.22 kg	2.90 kg	2.97 kg

- *1 Pressure gauge connection threads are not available for F.R.L. unit with a square embedded type pressure gauge or with a digital pressure switch.
- *2 -5 to 50 °C for the products with the digital pressure switch
- *3 For the following conditions in accordance with [Test condition: ISO 8573-4:2001 compliant, Test method ISO 12500-3:2009 compliant]
Conditions: When a new element is used, and the flow capacity, inlet pressure, and the amount of solid bodies on the filter inlet side are stable
- *4 The compressed air purity class is indicated based on ISO 8573-1:2010 Compressed air – Part 1: Contaminants and purity classes.
For details on this standard, refer to page 131.
- *5 The compressed air quality class on the inlet side is [7 : 4 : 4].
- *6 The flow rate is 5 drops or greater/min under the following conditions: Inlet pressure of 0.5 MPa; Class 1 turbine oil (ISO VG32); Temperature at 20 °C; Oil adjustment valve fully open.
For a circuit that repeatedly turns ON and OFF on the outlet side, make the adjustment so that the average air consumption per minute becomes the minimum dripping flow rate or more.

AC20A-D to AC60A-D Series

Dimensions

AC20A-D

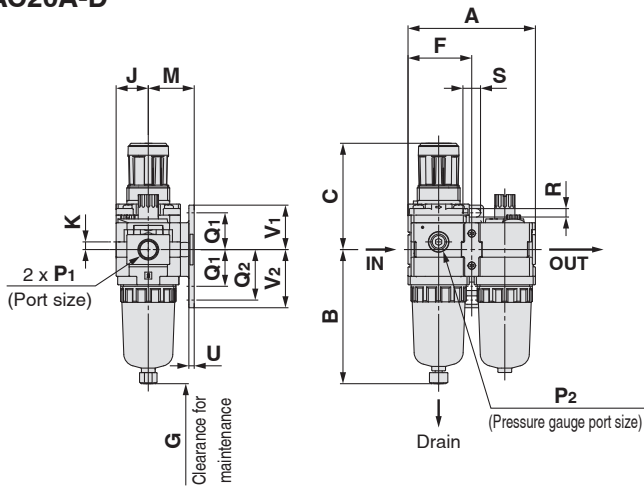

AC30A-D

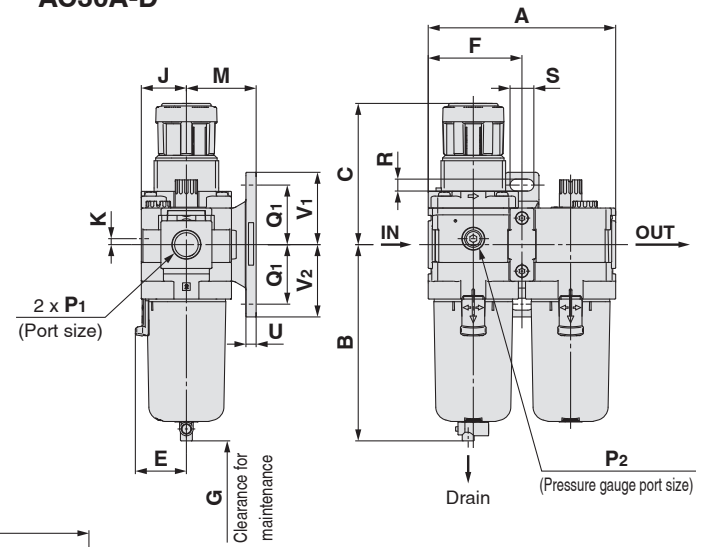

AC40A-D to AC40-06-D

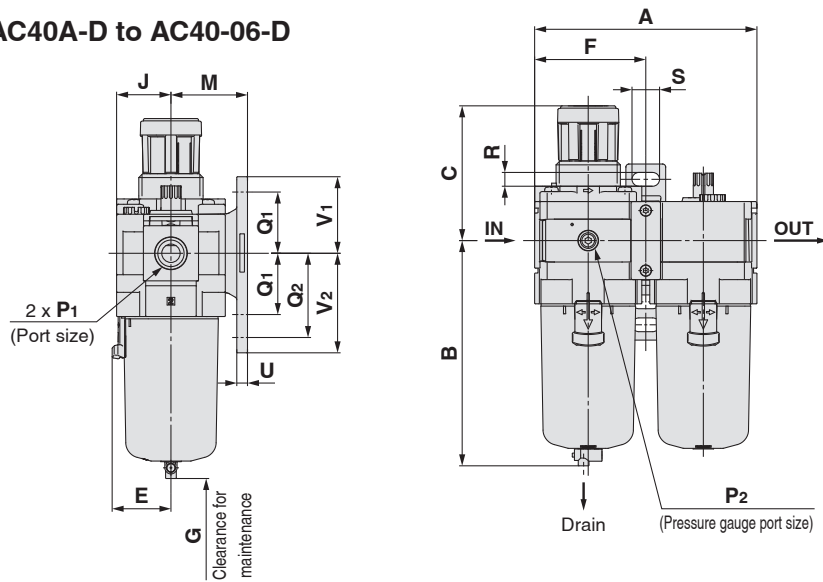

AC50A-D to AC60A-D

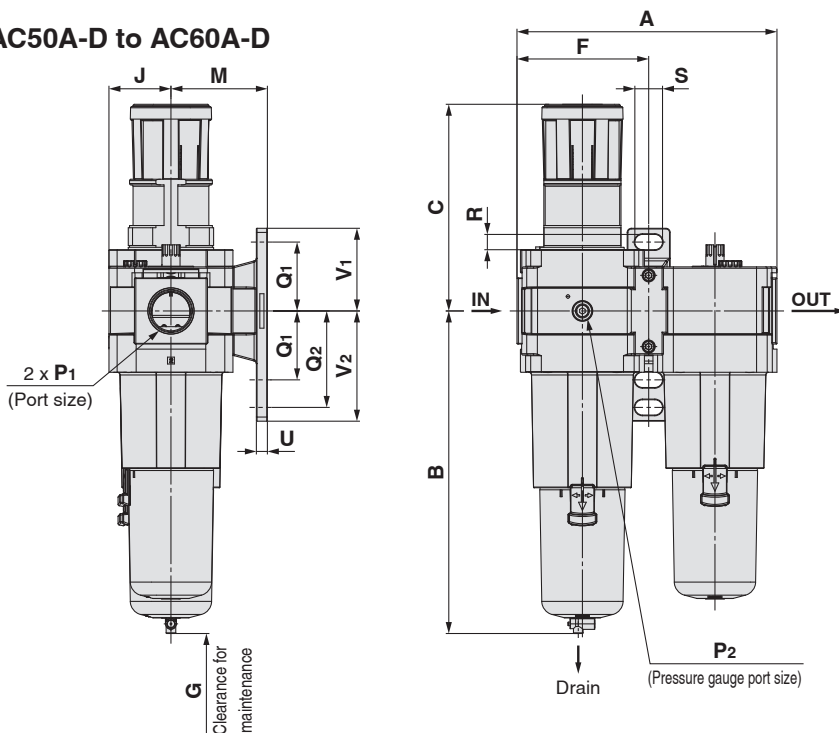

Air Combination **AC20A-D to AC60A-D Series**

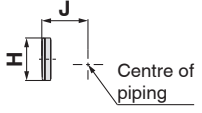
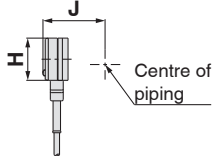
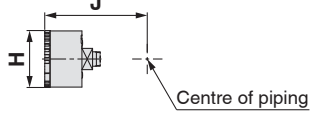
Applicable model	Optional specifications			
	Square embedded type pressure gauge	Digital pressure switch	Round type pressure gauge	Round type pressure gauge (with colour zone)
AC20A-D to AC60A-D				

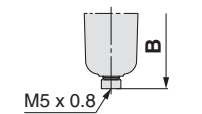
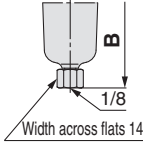
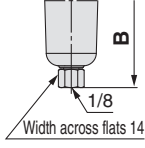
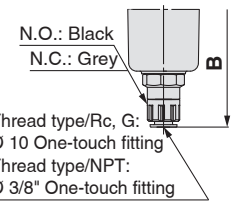
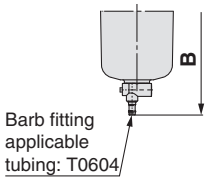
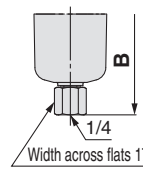
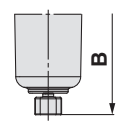
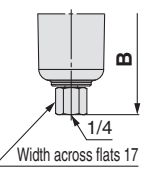
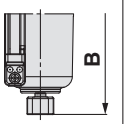
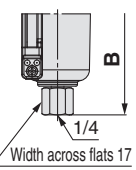
Applicable model	Optional specifications	Semi-standard					
	With auto drain	PC/PA bowl		Metal bowl		Metal bowl with level gauge	
		Drain cock with barb fitting	With drain guide	With drain cock	With drain guide	With drain cock	With drain guide
AC20A-D							
AC30A-D to AC60A-D	<p>N.O.: Black N.C.: Grey</p> <p>Thread type/Rc, G: O 10 One-touch fitting Thread type/NPT: O 3/8" One-touch fitting</p> 	<p>Barb fitting applicable tubing: T0604</p> 					

Model	Standard specifications																	
	P ₁	P ₂	A	B	C	E	F	G	J	K	M	Q ₁	Q ₂	R	S	U	V ₁	V ₂
AC20A-D	1/8, 1/4	1/8	83.2	87.6	71.8	—	41.6	60	21	5	30	24	33	5.5	11.5	3.5	29	38
AC30A-D	1/4, 3/8	1/8	110.2	115.3	86.5	30	55.1	80	26.5	3.5	41	35	—	7	14	6	42.5	42.5
AC40A-D	1/4, 3/8, 1/2	1/8	145.2	147.1	91.5	38.4	72.6	110	35.5	—	50	40	55	9	18	7	50	65
AC40A-06-D	3/4	1/8	155.2	149.1	93	38.4	77.6	110	35.5	—	50	40	55	9	18	7	50	65
AC50A-D	3/4, 1	1/8	191.2	234.1	155	—	98.1	110	45	—	70	50	70	11	20	8	60	80
AC60A-D	1	1/8	196.2	234.1	155	—	98.1	110	45	—	70	50	70	11	20	8	60	80

Model	Optional specifications										Semi-standard specifications						
	Square embedded type pressure gauge		Digital pressure switch		Round type pressure gauge		Round type pressure gauge (Semi-standard: Z)		Round type pressure gauge (with colour zone)		With auto drain	PC/PA bowl		Metal bowl		Metal bowl with level gauge	
	H	J	H	J	H	J	H	J	H	J		B	B	B	B	B	B
AC20A-D	□28	27	□27.8	37.5	○ 37.5	57.5	○ 37.5	58.5	○ 37.5	58.5	104.9	—	91.4	87.4	93.9	—	—
AC30A-D	□28	32.5	□27.8	43	○ 37.5	63	○ 37.5	64	○ 37.5	64	157.1	123.9	122.2	117.8	122.3	137.8	142.3
AC40A-D	□28	41.5	□27.8	52	○ 42.5	73	○ 42.5	73	○ 42.5	73	186.9	155.6	153.9	149.5	154	169.5	174
AC40A-06-D	□28	41.5	□27.8	52	○ 42.5	73	○ 42.5	73	○ 42.5	73	188.9	157.6	155.9	151.5	156	171.5	176
AC50A-D	□28	51	□27.8	61.5	○ 42.5	82.5	○ 42.5	82.5	○ 42.5	82.5	273.9	242.6	240.9	236.5	241	256.5	261
AC60A-D	□28	51	□27.8	61.5	○ 42.5	82.5	○ 42.5	82.5	○ 42.5	82.5	273.9	242.6	240.9	236.5	241	256.5	261

AC20A-D to AC60A-D Series

Dimensions: With Pressure Relief 3-Port Valve (V)

AC20A-V-D

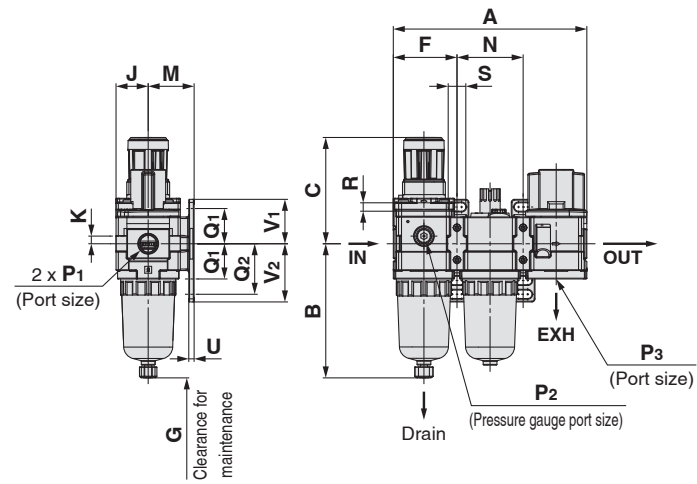

AC30A-V-D

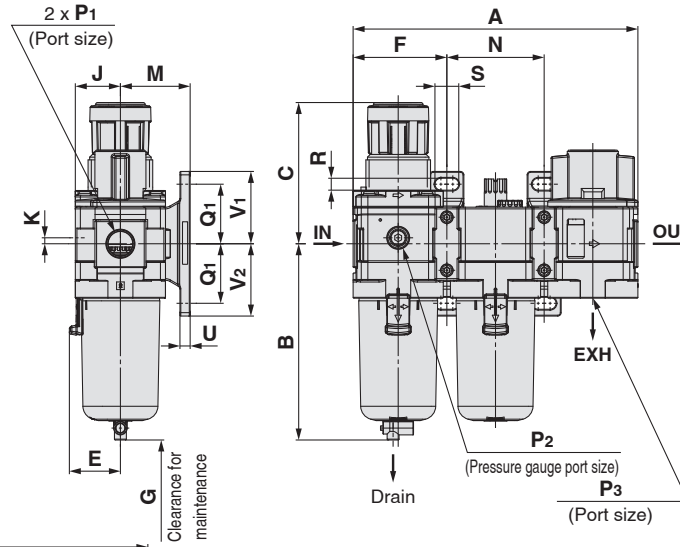

AC40A-V-D to AC40A-06-V-D

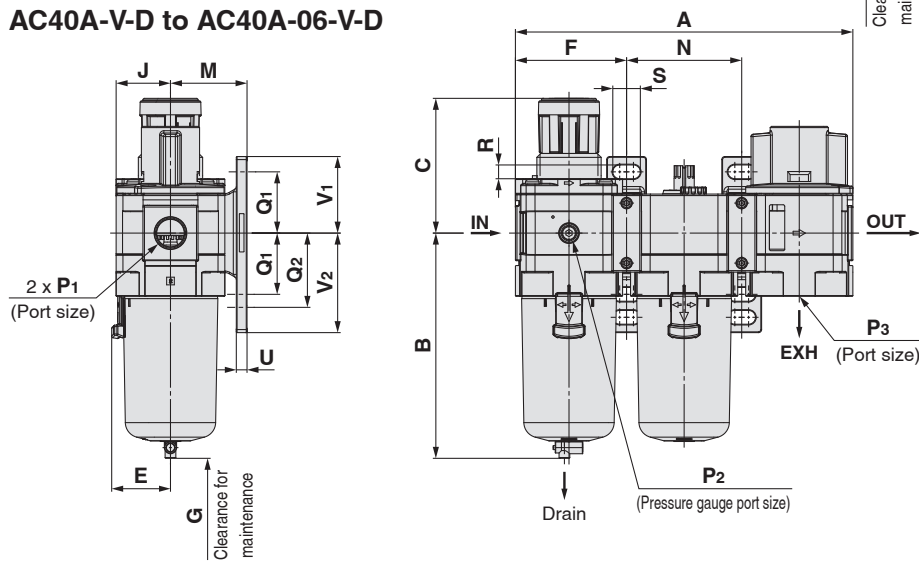

AC50A-V-D

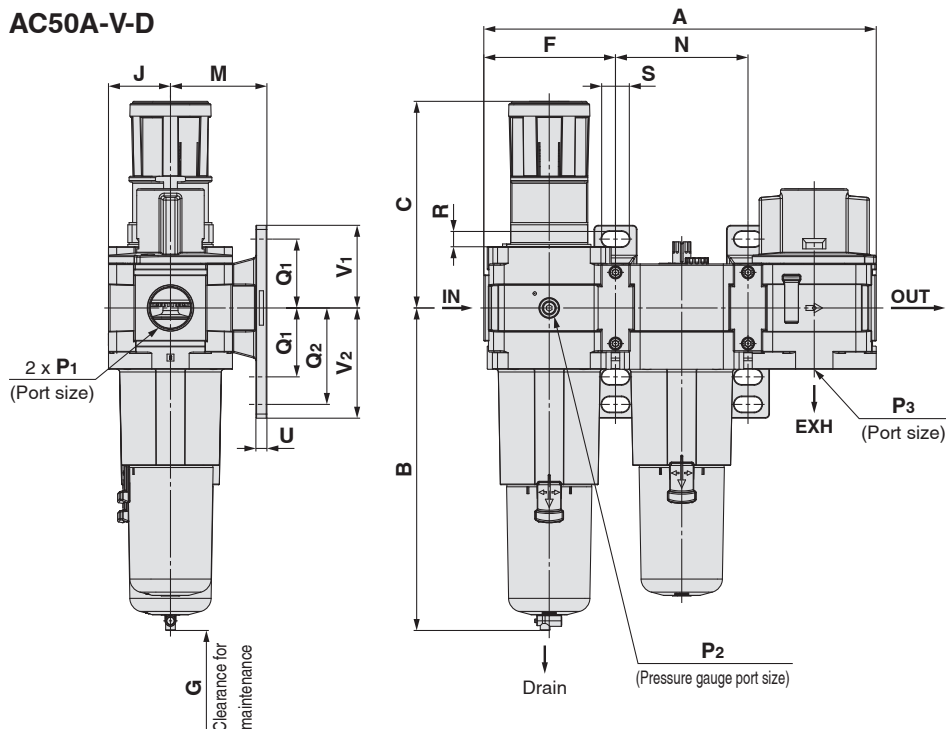

Air Combination **AC20A-D to AC60A-D Series**

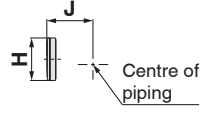
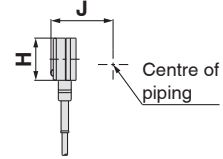
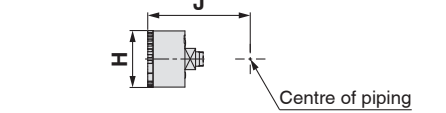
Applicable model	Optional specifications			
	Square embedded type pressure gauge	Digital pressure switch	Round type pressure gauge	Round type pressure gauge (with colour zone)
AC20A-V-D to AC50A-V-D				

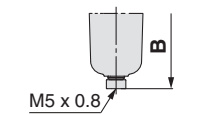
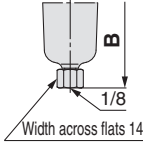
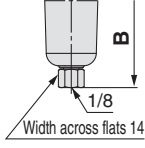
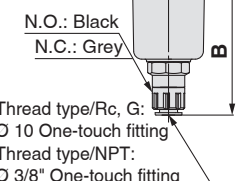
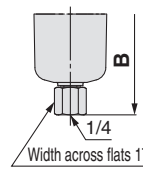
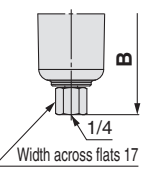
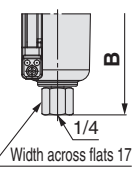
Applicable model	Optional specifications	Semi-standard					
	With auto drain	PC/PA bowl		Metal bowl		Metal bowl with level gauge	
		Drain cock with barb fitting	With drain guide	With drain cock	With drain guide	With drain cock	With drain guide
AC20A-V-D							
AC30A-V-D to AC50A-V-D	N.O.: Black N.C.: Grey Thread type/Rc, G: O 10 One-touch fitting Thread type/NPT: O 3/8" One-touch fitting						

Model	Standard specifications																			
	P ₁	P ₂	P ₃	A	B	C	E	F	G	J	K	M	N	Q ₁	Q ₂	R	S	U	V ₁	V ₂
AC20A-V-D	1/8, 1/4	1/8	1/8	126.4	87.6	71.8	—	41.6	60	21	5	30	43.2	24	33	5.5	11.5	3.5	29	38
AC30A-V-D	1/4, 3/8	1/8	1/4	167.4	115.3	86.5	30	55.1	80	26.5	3.5	41	57.2	35	—	7	14	6	42.5	42.5
AC40A-V-D	1/4, 3/8, 1/2	1/8	3/8	220.4	147.1	91.5	38.4	72.6	110	35.5	—	50	75.2	40	55	9	18	7	50	65
AC40A-06-V-D	3/4	1/8	1/2	235.4	149.1	93	38.4	77.6	110	35.5	—	50	80.2	40	55	9	18	7	50	65
AC50A-V-D	3/4, 1	1/8	1/2	287.4	234.1	155	—	98.1	110	45	—	70	96.2	50	70	11	20	8	60	80

Model	Optional specifications										Semi-standard specifications							
	Square embedded type pressure gauge		Digital pressure switch		Round type pressure gauge		Round type pressure gauge (Semi-standard: Z)		Round type pressure gauge (with colour zone)		With auto drain	PC/PA bowl		Metal bowl		Metal bowl with level gauge		
	H	J	H	J	H	J	H	J	H	J	B	With barb fitting	With drain guide	With drain cock	With drain guide	With drain cock	With drain guide	
AC20A-V-D	□28	27	□27.8	37.5	○ 37.5	57.5	○ 37.5	58.5	○ 37.5	58.5	104.9	—	B	B	B	B	—	—
AC30A-V-D	□28	32.5	□27.8	43	○ 37.5	63	○ 37.5	64	○ 37.5	64	157.1	123.9	122.2	117.8	122.3	137.8	142.3	
AC40A-V-D	□28	41.5	□27.8	52	○ 42.5	73	○ 42.5	73	○ 42.5	73	186.9	155.6	153.9	149.5	154	169.5	174	
AC40A-06-V-D	□28	41.5	□27.8	52	○ 42.5	73	○ 42.5	73	○ 42.5	73	188.9	157.6	155.9	151.5	156	171.5	176	
AC50A-V-D	□28	51	□27.8	61.5	○ 42.5	82.5	○ 42.5	82.5	○ 42.5	82.5	273.9	242.6	240.9	236.5	241	256.5	261	