

# Silencer

New

RoHS

The M5 silencer is now added!

Space saving



The resin silencer is now even more compact in size!

Existing model



New

New model

Entire length reduced by up to **30%** (SMC comparison)

Outside diameter reduced by up to **25%** (SMC comparison)

- Noise reduction improved: **30 dB(A)**  
The value of the noise reduction for the existing model AN□03 (compact type) is 25 dB(A).
- Sonic conductance C: 1 to 18 [dm<sup>3</sup>/(s·bar)]
- Connection method  
M thread, R (NPT) thread type  
One-touch fitting connection type



Series AN



CAT.EUS13-9A-UK

# Silencer Variation

M3	M5	1/8	1/4	3/8	1/2	3/4	1	1 1/4	1 1/2	2	Page
----	----	-----	-----	-----	-----	-----	---	-------	-------	---	------

**New Compact Resin Type/Male Thread**  
**Series AN05 to 40**  
 Compact, Lightweight  
 Noise reduction: 30 dB(A)

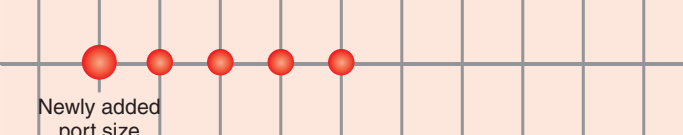
Page 2

**New Compact Resin Type/One-touch Fitting Connection**  
**Series AN10 to 30-C**  
 Can connect with one-touch fitting directly.  
 Noise reduction: 30 dB(A)

Page 3

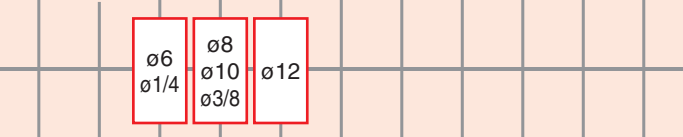
**Metal Body Type**  
**Series AN□00**  
 Low back pressure, Easy mounting.  
 Noise reduction: 30 dB(A)



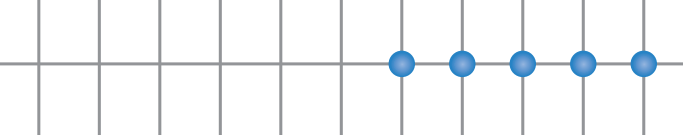

Page 4

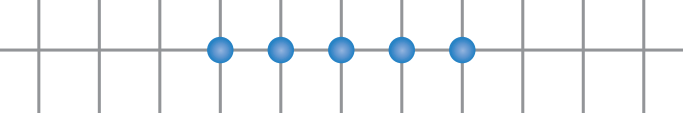
**Metal Case Type**  
**Series 25□□**  
 Prevents scattering of mist and noise.  
 Noise reduction: 19 dB(A)

**BC Sintered Body Type**  
**Series AN**  
 Noise reduction: 13, 16, 18, 21 dB(A)

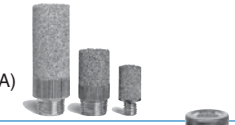

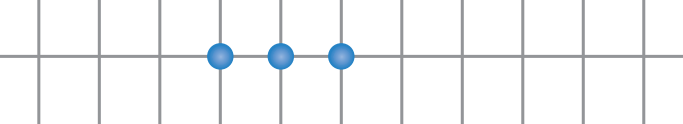

**High Noise Reduction Type**  
**Series AN□02**  
 Uses a flame resistant material for the case.  
 Noise reduction: 35 dB(A)

**High Noise Reduction Type**  
**Series ANA1**  
 Keeps the in-plant noise level below 85 dB(A). Noise reduction: 40 dB(A)

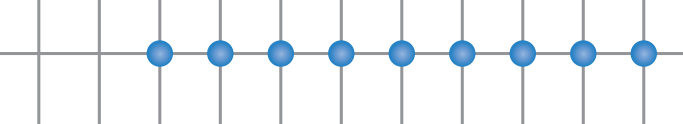
**High Noise Reduction Type**  
**Series ANB1**  
 Has a larger effective area than ANA1 series, but with the same port size. Noise reduction: 38 dB(A)

**5.0 MPa Type**  
**Series VCHN**  
 Max. operating pressure 5.0 MPa. Reduces clogging with the double-layer structure. Noise reduction: 35 dB(A)

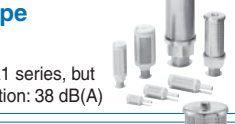
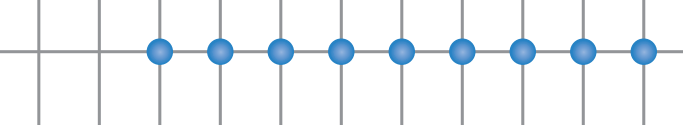

## Comparison between existing and new *The resin silencer is now even more compact in size!*

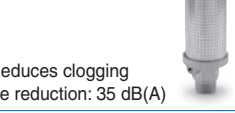
(AN200 to 400, AN103 to 403, AN103-KM6 to 300-KM12)

### Male Thread (Resin body)

Type	New model				Existing model								
	Model	Sonic conductance C [dm³/(s·bar)]	Length (mm)	Noise reduction	Standard				Compact type				
					Model	Sonic conductance C [dm³/(s·bar)]	Length (mm)	Noise reduction	Model	Sonic conductance C [dm³/(s·bar)]	Length (mm)	Noise reduction	
M5 x 0.8	AN05	1	15	30 dB(A)	—	—	—	—	—	—	—	—	—
1/8	AN10	2	23		—	—	—	—	AN103	2	23.5	25 dB(A)	
1/4	AN15	3	32		—	—	—	—	AN203	3	36		
	AN20	7	45		AN200	7	63	30 dB(A)	—	—	—	—	
3/8	AN30	12	58.5		AN300	12	84		AN303	7	66	25 dB(A)	
1/2	AN40	18	68		AN400	18	92		AN403	12	84		

### One-touch Fitting Connection (Resin body)

Type	New model				Existing model			
	Model	Sonic conductance C [dm³/(s·bar)]	Length (mm)	Noise reduction	Model	Sonic conductance C [dm³/(s·bar)]	Length (mm)	Noise reduction
ø6	AN10-C06	1.4	36.5	30 dB(A)	AN103-KM6	1.4	37	25 dB(A)
					AN103-X233			
AN103-X235								
ø8	AN15-C08	4	45		AN203-KM8	2.8	45	
					AN200-KM8	4	73	
ø10	AN20-C10	6	57.5		AN200-KM10	5.2	76	30 dB(A)
				AN300-KM10	6	90		
ø3/8	AN20-C11	5	—	—	—	—	—	
ø12	AN30-C12	8.2	71.5	AN300-KM12	8.2	91	30 dB(A)	

# Silencer

## Compact Resin Type/Male Thread

# Series AN05 to 40

RoHS

### How to Order

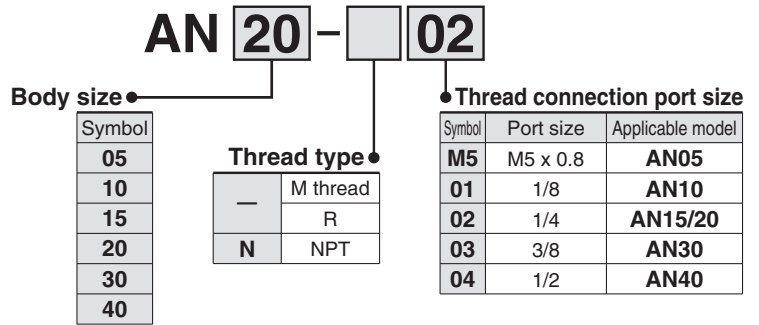

### Specifications

Fluid	Compressed air
Max. operating pressure <sup>Note 1)</sup>	1.0 MPa
Noise reduction	30 dB(A) <sup>Note 2)</sup>
Ambient and fluid temperature	5 to 60°C <sup>Note 3)</sup>

Note 1) It indicates the inlet pressure for solenoid valve.

Note 2) The value may vary, depending on the pneumatic circuit or pressure that is exhausted from the solenoid valve.

Note 3) The product can be used in temperatures -10 to 60°C if there is no risk of water droplets forming and freezing.

Refer to page 5 for Precautions on these products.

### Performance

Model	Effective area mm <sup>2</sup>	Sonic conductance C [dm <sup>3</sup> /(s·bar)]	Recommended flow m <sup>3</sup> /min(ANR)	Weight g
AN05-M5	5	1	0.4 or less	0.5
AN10-01	10	2	0.8 or less	1
AN15-02	15	3	1.0 or less	2.5
AN20-02	35	7	3.0 or less	4
AN30-03	60	12	5.0 or less	5.5
AN40-04	90	18	8.0 or less	8.5

Note) Recommended flow rate is the flow at 0.5 MPa in the inlet pressure.

### Construction/Parts/Dimensions

AN05/10/20

AN15/30/40

No hexagonal part  
in AN05 and AN10

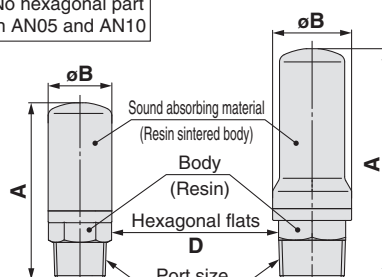

#### Dimensions

Model	Port size R, NPT	A	B	D
AN05-M5	M5 x 0.8	15	6.5	-
AN10-01	1/8	23	11	-
AN15-02	1/4	32	16	14
AN20-02	1/4	45	16.5	14
AN30-03	3/8	58.5	20	17
AN40-04	1/2	68	24	21

# Silencer

## Compact Resin Type/One-touch Fitting Connection

# Series AN10 to 30-C

RoHS

### How to Order



AN **20** - C **10**

Body size

Symbol
10
15
20
30

Applicable one-touch fitting size

Symbol	Port size	Applicable model
06	ø6	AN10
07	ø1/4	AN10
08	ø8	AN15
10	ø10	AN20
11	ø3/8	AN20
12	ø12	AN30

Connection type

Symbol	Connection type
C	One-touch fitting connection

### Specifications

Fluid	Compressed air
Max. operating pressure <sup>Note 1)</sup>	1.0 MPa
Noise reduction	30 dB(A) <sup>Note 2)</sup>
Ambient and fluid temperature	5 to 60°C <sup>Note 3)</sup>

Note 1) It indicates the inlet pressure for solenoid valve.

Note 2) The value may vary, depending on the pneumatic circuit or pressure that is exhausted from the solenoid valve.

Note 3) The product can be used in temperatures -10 to 60°C if there is no risk of water droplets forming and freezing.

Refer to page 5 for Precautions on these products.

### Performance

Model	Effective area mm <sup>2</sup>	Sonic conductance C [dm <sup>3</sup> /(s·bar)]	Recommended flow m <sup>3</sup> /min(ANR)	Weight g
AN10-C06	7	1.4	0.8 or less	1
AN10-C07				1
AN15-C08	20	4	3.0 or less	1.4
AN20-C10	30	6	5.0 or less	3.5
AN20-C11	25	5	3.0 or less	3.5
AN30-C12	41	8.2	5.0 or less	5

Note) Recommended flow rate is the flow at 0.5 MPa in the inlet pressure.

### Construction/Parts/Dimensions

#### AN10-C to 30-C

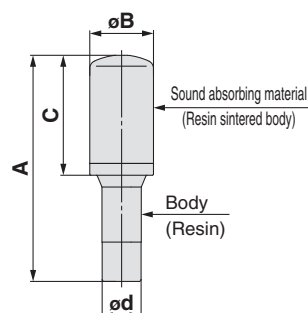

#### Dimensions

Model	A	B	C	ød
AN10-C06	36.5	11	14.5	ø6
AN10-C07				ø1/4
AN15-C08	45	13	20	ø8
AN20-C10	57.5	16.5	30.5	ø10
AN20-C11				ø3/8
AN30-C12	71.5	20	43.5	ø12

# Silencer Metal Body Type Series AN□00



Noise reduction 30 dB(A)  
Low back pressure  
Easy mounting



JIS Symbol

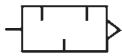

## How to Order

AN 500 - □ 06

Body size

Symbol
500
600
700
800
900

Thread type

Symbol	Type
—	R
N	NPT

Port size

Symbol	Port size	Applicable model
06	3/4	AN500
10	1	AN600
12	1 1/4	AN700
14	1 1/2	AN800
20	2	AN900

## Specifications

Fluid	Compressed air
Max. operating pressure <sup>Note 1)</sup>	1.0 MPa
Noise reduction	30 dB(A) <sup>Note 2)</sup>
Ambient and fluid temperature	5 to 60°C <sup>Note 3)</sup>

Note 1) It indicates the inlet pressure for solenoid valve.

Note 2) The value may vary, depending on the pneumatic circuit or pressure that is exhausted from the solenoid valve.

Note 3) The product can be used in temperatures -10 to 60°C if there is no risk of water droplets forming and freezing.

Refer to page 5 for Precautions on these products.

## Performance

Model	Effective area mm <sup>2</sup>	Sonic conductance C [dm <sup>3</sup> /(s·bar)]	Recommended flow m <sup>3</sup> /min(ANR)	Weight g
AN500-06	160	32	12 or less	165
AN600-10	270	54	20 or less	220
AN700-12	440	88	30 or less	435
AN800-14	590	118	50 or less	510
AN900-20	960	192	80 or less	740

Note) Recommended flow rate is the flow at 0.5 MPa in the inlet pressure.

## Construction/Parts/Dimensions

### AN500 to 900

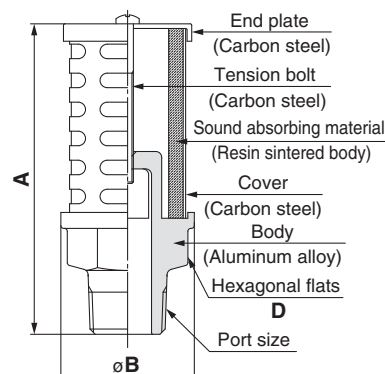

### Dimensions

Model	Port size R, NPT	A	B	D
AN500-06	3/4	107	46	36
AN600-10	1	127	50	41
AN700-12	1 1/4	186	74	50
AN800-14	1 1/2	217	74	55
AN900-20	2	256	86	65



## Series AN

# Specific Product Precautions

Be sure to read before handling. Refer to back cover for Safety Instructions.

### Design

#### Warning

1. **The silencer clogging may result in a blocked exhaust port.**  
Provide a safety design so as not to cause the whole system to malfunction.

#### Caution

1. **The silencer is intended to reduce the noise of compressed air that is exhausted from the pneumatic equipment.**  
Since noises generated by sources other than the exhaust, such as noise generated inside piping, equipment vibration and solenoid valve switching, cannot be reduced, locate the cause of these noises and take countermeasures.  
The product does not function as a filter. Do not use the product as a filter regardless of negative and positive pressures.
2. **If the compressed air supply is contaminated with fluids such as oil and oil mist, such fluids will be dispersed to the environment.**  
In such a case, an exhaust cleaner is recommended to recover fluids and reduce noise.
3. **The value of the noise reduction may vary, depending on the pneumatic circuit or pressure that is exhausted from the solenoid valve.**

### Selection

#### Caution

1. **When selecting the silencer, the sonic conductance\* (including combined sonic conductance) of the silencer should be larger than that of the solenoid valve.**  
\*Sonic conductance C [dm<sup>3</sup>/(s·bar)] = Effective area [mm<sup>2</sup>] ÷ 5
2. **Use within the range of specifications.**

### Operating Environment

#### Warning

1. **Do not use in an atmosphere having corrosive gases, chemicals, sea water, water, water steam, or where there is direct contact with any of these.**  
Refer to the construction drawings for silencer materials.
2. **Avoid exposure to direct sunlight.**
3. **Do not operate in locations where vibration or impact occurs.**
4. **Do not use the product in locations where it is near heat sources and exposed to radiation heat.**
5. **Do not use in an environment where the product is exposed to cutting oil, lubricating oil, or coolant, etc.**  
If it is used in an environment where there is possible contact with cutting oil, lubricating oil, or coolant, exercise preventive measures.
6. **Do not use in an environment where foreign matter may stick to the product or get mixed in the product's interior.**  
It may result in clogging at an early stage, coming off or causing damage.

### Mounting

#### Caution

1. **If the silencer body is made of resin and is tightened too much, the silencer may be damaged.**
2. **Tightening by using a pipe wrench or pliers may cause damage to the silencer. This method is not recommended.**

Please follow the procedures below for mounting.

##### When the body is made of resin

Hold the tip of the body (the side without thread) and screw it in. At the point where the thread begins to feel tight, use a wrench on the hexagonal flats to tighten an additional 1/4 turn. Tighten the AN05-M5 by hand completely until the ends of the fitting come into contact with the mounting surface. Then apply additional tightening. Note that the additional tightening should be 30° or less. (Tighten it with 0.1 N·m or less.)

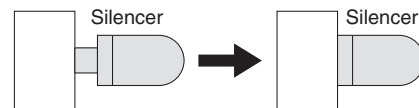

##### When the body is made of metal

Within the recommended tightening torque shown in the table below, use a wrench on the hexagonal flats and tighten.

##### Tightening Torque (Metal type)

Connection thread	Applicable tightening torque N·m
R 3/4	28 to 30
R1	36 to 38
R1 1/4	40 to 42
R1 1/2	48 to 50
R2	48 to 50

3. **Make sure not to apply a lateral load to the body during or after the installation.**
4. **When the silencer body is loosened by vibration, etc. of equipment on which a silencer is assembled, apply glue to threads to prevent loosening and reattach.**

### Maintenance

#### Caution



1. **The sound absorbing material is not replaceable.**  
Since the sound absorbing material is not replaceable, never disassemble the product.
2. **If the exhaust speed drops and the system performance decreases due to clogging, replace with a new silencer.**  
Make sure to verify the operating conditions of the actuator at least once a day.
3. **If operation continues when it is clogged, breakage can result.**





## Safety Instructions

These safety instructions are intended to prevent hazardous situations and/or equipment damage. These instructions indicate the level of potential hazard with the labels of “**Caution**,” “**Warning**” or “**Danger**.” They are all important notes for safety and must be followed in addition to International Standards (ISO/IEC)\*1), and other safety regulations.

-  **Caution:** **Caution** indicates a hazard with a low level of risk which, if not avoided, could result in minor or moderate injury.
-  **Warning:** **Warning** indicates a hazard with a medium level of risk which, if not avoided, could result in death or serious injury.
-  **Danger:** **Danger** indicates a hazard with a high level of risk which, if not avoided, will result in death or serious injury.

- \*1) ISO 4414: Pneumatic fluid power – General rules relating to systems.
- ISO 4413: Hydraulic fluid power – General rules relating to systems.
- IEC 60204-1: Safety of machinery – Electrical equipment of machines. (Part 1: General requirements)
- ISO 10218-1: Manipulating industrial robots - Safety. etc.

### Warning

- 1. The compatibility of the product is the responsibility of the person who designs the equipment or decides its specifications.**  
Since the product specified here is used under various operating conditions, its compatibility with specific equipment must be decided by the person who designs the equipment or decides its specifications based on necessary analysis and test results. The expected performance and safety assurance of the equipment will be the responsibility of the person who has determined its compatibility with the product. This person should also continuously review all specifications of the product referring to its latest catalogue information, with a view to giving due consideration to any possibility of equipment failure when configuring the equipment.
- 2. Only personnel with appropriate training should operate machinery and equipment.**  
The product specified here may become unsafe if handled incorrectly. The assembly, operation and maintenance of machines or equipment including our products must be performed by an operator who is appropriately trained and experienced.
- 3. Do not service or attempt to remove product and machinery/equipment until safety is confirmed.**
  1. The inspection and maintenance of machinery/equipment should only be performed after measures to prevent falling or runaway of the driven objects have been confirmed.
  2. When the product is to be removed, confirm that the safety measures as mentioned above are implemented and the power from any appropriate source is cut, and read and understand the specific product precautions of all relevant products carefully.
  3. Before machinery/equipment is restarted, take measures to prevent unexpected operation and malfunction.
- 4. Contact SMC beforehand and take special consideration of safety measures if the product is to be used in any of the following conditions.**
  1. Conditions and environments outside of the given specifications, or use outdoors or in a place exposed to direct sunlight.
  2. Installation on equipment in conjunction with atomic energy, railways, air navigation, space, shipping, vehicles, military, medical treatment, combustion and recreation, or equipment in contact with food and beverages, emergency stop circuits, clutch and brake circuits in press applications, safety equipment or other applications unsuitable for the standard specifications described in the product catalogue.
  3. An application which could have negative effects on people, property, or animals requiring special safety analysis.
  4. Use in an interlock circuit, which requires the provision of double interlock for possible failure by using a mechanical protective function, and periodical checks to confirm proper operation.

### Caution

- 1. The product is provided for use in manufacturing industries.**  
The product herein described is basically provided for peaceful use in manufacturing industries.  
If considering using the product in other industries, consult SMC beforehand and exchange specifications or a contract if necessary.  
If anything is unclear, contact your nearest sales branch.

## Limited warranty and Disclaimer/ Compliance Requirements

The product used is subject to the following “Limited warranty and Disclaimer” and “Compliance Requirements”.

Read and accept them before using the product.

### Limited warranty and Disclaimer

1. The warranty period of the product is 1 year in service or 1.5 years after the product is delivered.\*2)  
Also, the product may have specified durability, running distance or replacement parts. Please consult your nearest sales branch.
2. For any failure or damage reported within the warranty period which is clearly our responsibility, a replacement product or necessary parts will be provided.  
This limited warranty applies only to our product independently, and not to any other damage incurred due to the failure of the product.
3. Prior to using SMC products, please read and understand the warranty terms and disclaimers noted in the specified catalogue for the particular products.

\*2) Vacuum pads are excluded from this 1 year warranty.

A vacuum pad is a consumable part, so it is warranted for a year after it is delivered. Also, even within the warranty period, the wear of a product due to the use of the vacuum pad or failure due to the deterioration of rubber material are not covered by the limited warranty.

### Compliance Requirements

1. The use of SMC products with production equipment for the manufacture of weapons of mass destruction (WMD) or any other weapon is strictly prohibited.
2. The exports of SMC products or technology from one country to another are governed by the relevant security laws and regulations of the countries involved in the transaction. Prior to the shipment of a SMC product to another country, assure that all local rules governing that export are known and followed.

## Safety Instructions

Be sure to read “Handling Precautions for SMC Products” (M-E03-3) before using.

### SMC Corporation (Europe)

Austria	☎ +43 (0)2262622800	www.smc.at	office@smc.at
Belgium	☎ +32 (0)33551464	www.smc-pneumatics.be	info@smc-pneumatics.be
Bulgaria	☎ +359 (0)2807670	www.smc.bg	office@smc.bg
Croatia	☎ +385 (0)13707288	www.smc.hr	office@smc.hr
Czech Republic	☎ +420 541424611	www.smc.cz	office@smc.cz
Denmark	☎ +45 70252900	www.smc.dk.com	smc@smc.dk.com
Estonia	☎ +372 6510370	www.smc-pneumatics.ee	smc@smc-pneumatics.ee
Finland	☎ +358 207513513	www.smc.fi	smc.fi@smc.fi
France	☎ +33 (0)164761000	www.smc-france.fr	promotion@smc-france.fr
Germany	☎ +49 (0)61034020	www.smc-pneumatik.de	info@smc-pneumatik.de
Greece	☎ +30 210 2717265	www.smc-hellas.gr	sales@smc-hellas.gr
Hungary	☎ +36 23511390	www.smc.hu	office@smc.hu
Ireland	☎ +353 (0)14039000	www.smc-pneumatics.ie	sales@smc-pneumatics.ie
Italy	☎ +39 0292711	www.smc-italia.it	mailbox@smc-italia.it
Latvia	☎ +371 67817700	www.smc.lv	info@smc.lv

Lithuania	☎ +370 5 2308118	www.smclt.lt	info@smclt.lt
Netherlands	☎ +31 (0)205318888	www.smc-pneumatics.nl	info@smc-pneumatics.nl
Norway	☎ +47 67129020	www.smc-norge.no	post@smc-norge.no
Poland	☎ +48 (0)222119616	www.smc.pl	office@smc.pl
Portugal	☎ +351 226166570	www.smc.eu	postpt@smc.smces.es
Romania	☎ +40 213205111	www.smcromania.ro	smcromania@smcromania.ro
Russia	☎ +7 8127185445	www.smc-pneumatik.ru	info@smc-pneumatik.ru
Slovakia	☎ +421 (0)413213212	www.smc.sk	office@smc.sk
Slovenia	☎ +386 (0)73885412	www.smc.si	office@smc.si
Spain	☎ +34 945184100	www.smc.eu	post@smc.smces.es
Sweden	☎ +46 (0)86031200	www.smc.nu	post@smc.nu
Switzerland	☎ +41 (0)523963131	www.smc.ch	info@smc.ch
Turkey	☎ +90 212 489 0 440	www.smc-pneumatik.com.tr	info@smc-pneumatik.com.tr
UK	☎ +44 (0)845 121 5122	www.smc-pneumatics.co.uk	sales@smc-pneumatics.co.uk