

# Series Compatible with Secondary Batteries

## 25A-Series

Copper (Cu)  
and Zinc (Zn)  
Restrictions

Compatible with dew  
points as low as

**-70 °C**

**Longer life**

due to use of grease  
compatible with low  
dew points

A wide range  
of products!  
Now with a  
greater number  
of models!



Compatible with the various environments  
of each manufacturing process



P-EU18-13-UK

Products compatible with the environments of the secondary battery manufacturing process are available, contributing to the improvement of productivity and reduced defects.

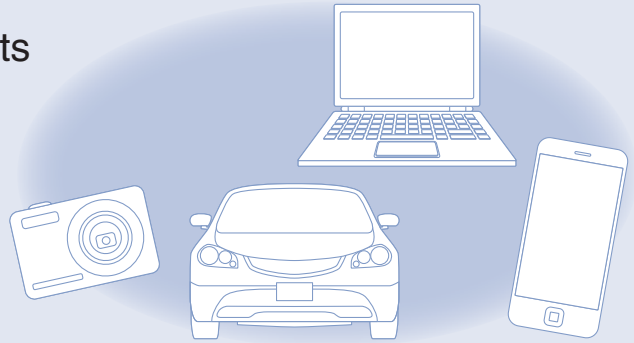

## Series Compatible with Secondary Batteries 25A- Series



### Improved performance in environments with low dew points

- Uses grease compatible with low dew points

#### Double the durability

Durability comparison (Air cylinder)

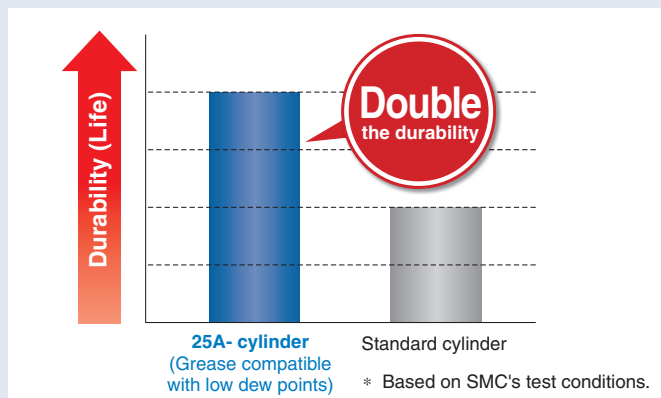

#### Response time reduced by half

Comparison of cylinder response times after being pressurised and stored

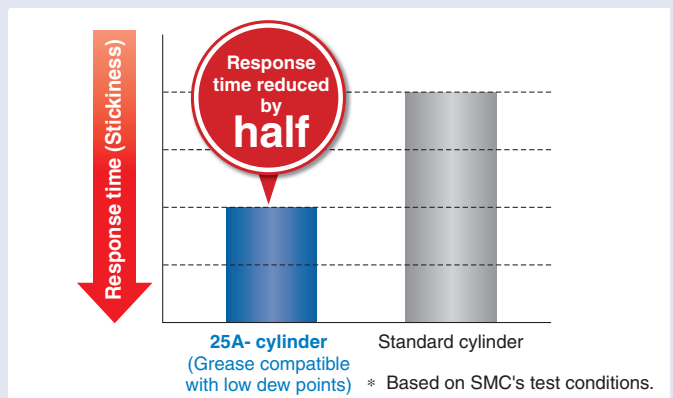

## Material Restrictions

The following materials are not used in order to reduce the number of defective products produced during the secondary battery manufacturing process:

- **Metal materials whose main component is either copper or zinc are not used.**
  - \* Some of the aluminium alloy and aluminium die-cast materials contain traces of copper or zinc as an additive element. If a product with restrictions on the amounts of these additive elements is required, we can accommodate your needs via a special product. Please contact your local sales representative for further details.
- **Electrolytic nickel plating with a copper layer or zinc plating**
  - \* Electroless nickel plating is used.
- **Parts of the piston rod, clevis pin, split pin, etc., of the cylinder are made of carbon steel with hard chrome plating. Therefore, as the processed parts aren't coated, an anti-rust oil coating is applied to these parts before shipment.**
  - \* Rust may be generated due to the operating environment. If the generation of rust is a problem, made-to-order options using stainless steel, etc., are available. Please contact your local sales representative for further details.
- **The coils of solenoid valves, the circuit boards of electrical equipment, the motors of electric actuators, etc., use copper materials.**
  - \* Parts whose materials cannot be easily changed to alternative ones and parts whose functions would be compromised by changing to alternative materials use copper and/or zinc materials. Please contact your local sales representative for further details.

# Dustproof Products

**Durability is 4 times stronger than the standard model in micro-powder (10 to 100 μm) environments.**

(The durability test was conducted in accordance with SMC test conditions.)





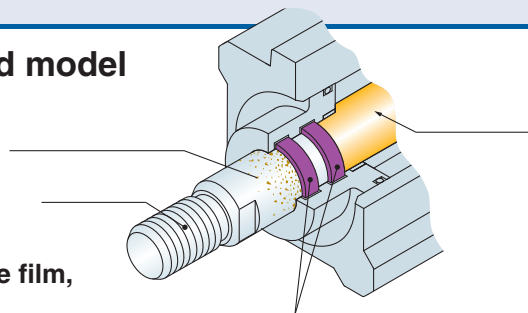



**Cylinder with Stable Lubrication Function (Lube-retainer)**

- Double Lube-retainer
- Lube-retainers are mounted at two locations to form a grease film, preventing the entry of dust and foreign matter.



\* Not compatible with the secondary battery specifications

## Applicable Cylinders

<b>Air Cylinder CM2 Series</b> Ø 20 to Ø 40  RoHS	<b>Air Cylinder CG1 Series</b> Ø 20 to Ø 100  RoHS	<b>Air Cylinder CA2 Series</b> Ø 40 to Ø 100  RoHS	<b>Compact Cylinder CQS Series</b> Ø 20 to Ø 25  RoHS
<b>Compact Cylinder CQ2 Series</b> Ø 32 to Ø 100  RoHS	<b>Air Slide Table MXQ□A Series</b> Ø 6 to Ø 25  RoHS	<b>Compact Guide Cylinder MGP Series</b> Ø 20 to Ø 100  RoHS	<b>Dual Rod Cylinder CXS Series</b> Ø 6 to Ø 32  RoHS

## Special Products (Please contact your local sales representative for more details.)

**Lube-retainer + Heavy-duty scraper**

- Improved dust prevention due to the lube-retainer and heavy-duty scraper

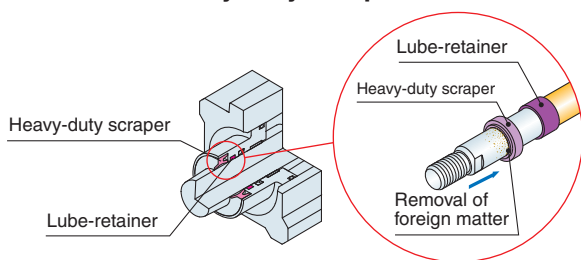

**Double Lube-retainer + Urethane seal**

- Material of rod seal has been changed to urethane to improve durability.

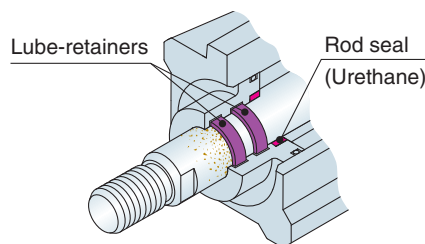

# Explosion-proof Products

**Explosion-proof Solenoid Valves**

- 5-Port Solenoid Valve/51-SY Series  
Intrinsically safe and explosion proof  
(In compliance with IEC Standard 79)
- 3/5-Port Solenoid Valve/50-VFE/VPE Series  
IEC compliant, Waterproof

\* Not compatible with the secondary battery specifications

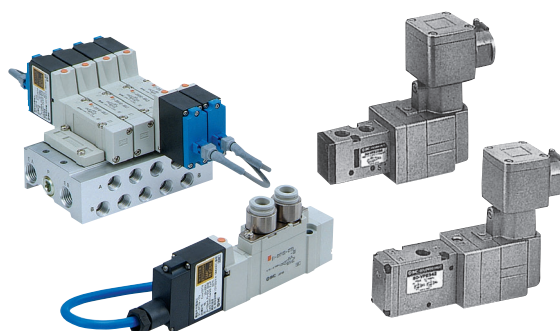



# Restrictions

**Material**

**Copper (Cu)**

**Zinc (Zn)**

**Surface treatment**

- Electrolytic nickel plating with a copper layer
  - Zinc plating
- (Electroless nickel plating is used.)

## Solenoid Valve 25A-SY Series

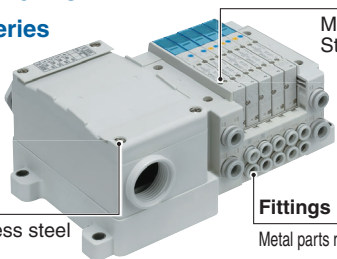

**Mounting bolt**  
Material: Stainless steel

**Cover holding screw**  
Material: Stainless steel

**Fittings**  
Metal parts material: Stainless steel

\* Coils for solenoid valves, connector pins, and lead wires are made of copper.  
\* Manifold terminal block, wiring parts, connector metal parts, and printed circuit board are made of copper.

## Cylinder 25A-CA2 Series

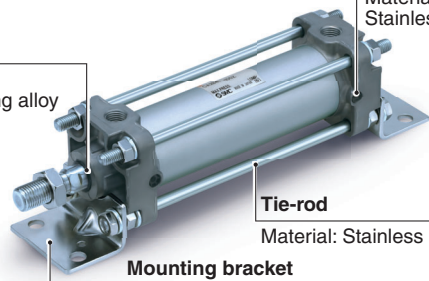

**Bushing**  
Material: Steel bearing alloy

**Cushion valve**  
Material: Stainless steel

**Tie-rod**  
Material: Stainless steel

**Mounting bracket**  
Surface treatment: Electroless nickel plating

## Compact Cylinder 25A-CQ2 Series

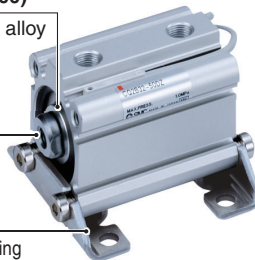

**Bushing (Ø 50 to Ø 100)**  
Material: Steel bearing alloy

**Piston rod**  
Surface treatment: Hard chrome plating

**Mounting bracket**  
Surface treatment: Electroless nickel plating

\* The auto switch magnet contains copper and/or zinc. (Ø 12)

## Compact Guide Cylinder 25A-MGPM Series



**Bushing (Ø 50 to Ø 100)**  
Material: Steel bearing alloy

**Piston rod**  
Surface treatment: Hard chrome plating

**Plate**  
Surface treatment: Electroless nickel plating

\* The auto switch magnet contains copper and/or zinc. (Ø 12)

## Air Slide Table 25A-MXQ Series

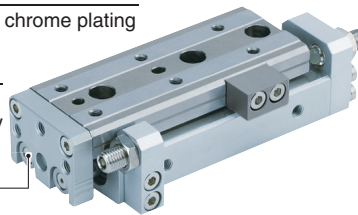

**Piston rod**  
Surface treatment: Hard chrome plating

**Piston**  
Material: Stainless steel  
Aluminium alloy

**Bolts**  
Surface treatment: Electroless nickel plating

## Corrosion-resistant Air Slide Table (Made to Order: 25A-MXQ□-X771, 25A-MXS□-X1949)

The material of the head cap part has been changed to a highly corrosion-resistant material.



	After change	Before change
Head cap	Aluminium alloy	Synthetic resin

## Dual Rod Cylinder/Compact Type 25A-CXSJ Series

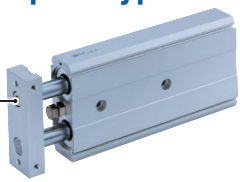

**Bolts**  
Surface treatment: Electroless nickel plating

\* The auto switch magnet contains copper and/or zinc. (Ø 6, Ø 10, Ø 15)

## Air Gripper 25A-MH22 Series

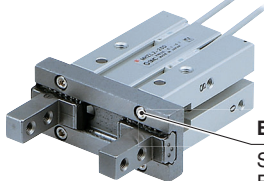

**Bolts**  
Surface treatment: Electroless nickel plating

\* Cylinder mounting brackets made of steel are either electroless nickel plated, treated with RAYDENT®, or coated with electrodeposition paint.



## Air Filter 25A-AF Series

**Rod (AF50 to 60-D)**  
Material: Stainless steel

**Drain plug (AF30 to 60-A, AF30 to 60-D)**  
Material: Stainless steel



## Regulator 25A-AR Series

**Valve, Stem**  
Material: Stainless steel

**Adjusting spring, Screw**  
Surface treatment: Electroless nickel plating



## Precision Regulator 25A-IR□-A Series

**Screw**  
Surface treatment: Electroless nickel plating

**Screws**  
Material: Stainless steel



## Vacuum Regulator 25A-IRV Series

**Stem, Valve, Screws**  
Material: Stainless steel

**Seal, O-ring**  
Material: EPDM

**Fittings**  
Metal material: Stainless steel

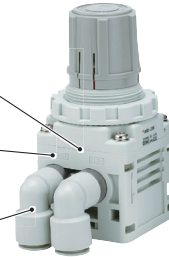

## 3-Colour Display High-Precision Digital Pressure Switch ZSE20□(F)/ISE20□ Series



**Port thread**  
Material: Stainless steel

\* A copper material is used for the lead wires.

## Pilot Operated 2-Port Solenoid Valve 25A-VXD Series

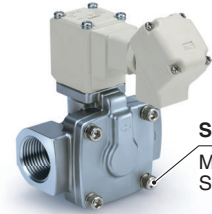

**Screw**  
Material: Stainless steel

\* A copper material is used for the solenoid coils and lead wires.

## Solid State Auto Switch D-M9□-900 Series

**Mounting screw**  
Material: Stainless steel



\* A copper material is used for the lead wires.

## Electric Actuator/Slider Type Ball Screw Drive 25A-LEFS Series

**Bolts**  
Material: Stainless steel

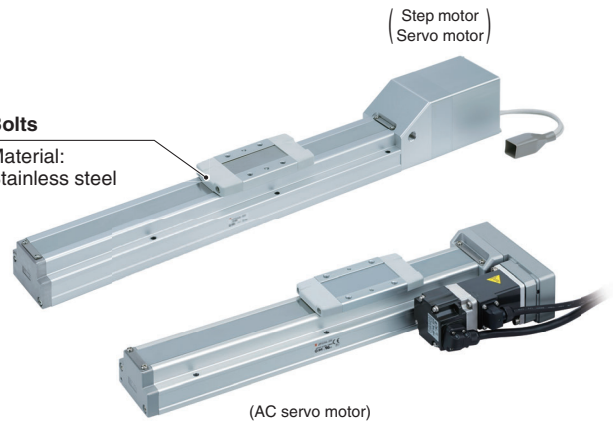

\* Copper and zinc materials are used for the motors, cables, controllers/drivers.  
\* The motor magnet contains copper and/or zinc.

## Electric Actuator/High Rigidity Slider Type Ball Screw Drive 25A-LEJS Series

**Bolts**  
Material: Stainless steel

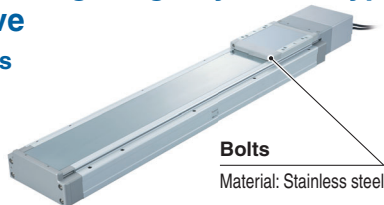

\* Copper and zinc materials are used for the motors, cables, controllers/drivers.  
\* The motor magnet contains copper and/or zinc.

## Electric Actuator/Rod Type 25A-LEY Series

**Bushing**  
Material: Steel bearing alloy

**Bolts**  
Material: Stainless steel

**Bushing**  
Material: Steel bearing alloy

**Bolts**  
Material: Stainless steel

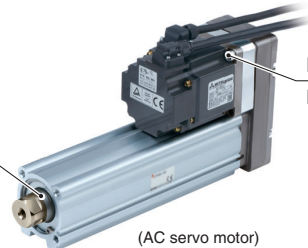
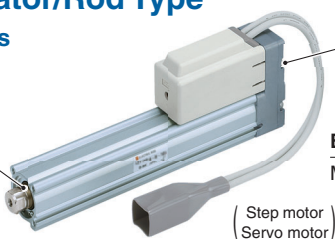

\* Copper and zinc materials are used for the motors, cables, controllers/drivers. \* The motor magnet contains copper and/or zinc.

# Secondary Battery Manufacturing Process

## Electrode Production Process

Same for both can types and laminate types

### 1 Mixing and kneading machine

The proper amount of raw materials for positive or negative electrodes are mixed to make electrode slurry.

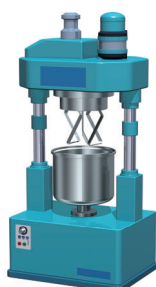
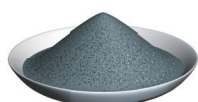

### 2 Coating and rolling

Positive or negative electrode slurry is coated with a metallic foil made from aluminium, copper, etc. The coated slurry is then compressed with rollers continuously to enhance the density of the electrode sheet.

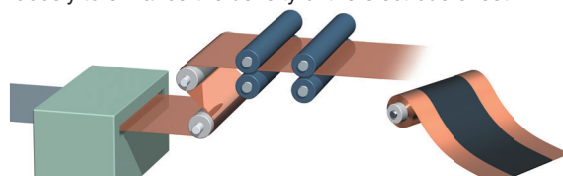

Electrode (Negative)

## Cell Assembly Process

### 4 Winder (Winding)

The positive electrode sheet, negative electrode sheet, and separator sheets are laid on top of each other and wound to form a wound body.

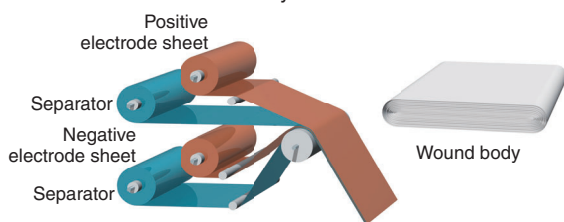

Can type

### 5 Attaching tabs and an insulating plate and inserting into a case

Current collecting tabs and an insulating plate are bonded to the wound body. It is then inserted into a case.

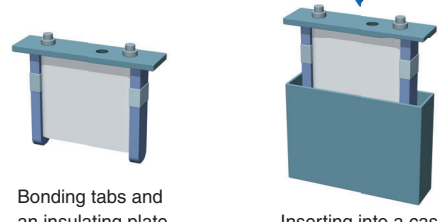

Bonding tabs and an insulating plate

Inserting into a case

### 4 Punching electrodes

The rolled positive and negative electrodes are punched according to the battery size.

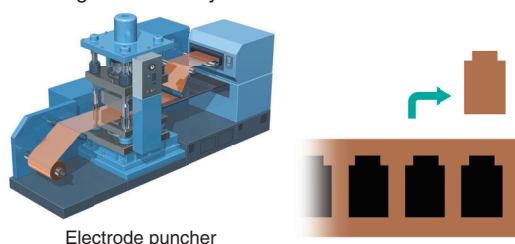

Electrode puncher

Laminate type

### 5 Stacking (Layering)

Positive and negative electrodes are stacked alternately and accurately at high speed with a separator inserted between them.

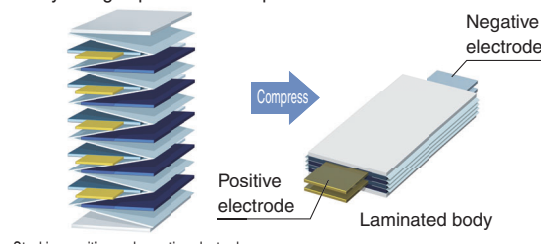

Stacking positive and negative electrodes

Positive electrode

Laminated body

## Inspection/Packaging Process

### 8 Charging/discharging and aging

Standard products are applicable.

Charging and discharging are repeated to activate batteries. Charged battery cells are then left for a certain period of time, and the initial deterioration of batteries is checked to detect defective products.



Activation of batteries

Aging

Same for both can types and laminate types

### 9 Packaging

Standard products are applicable.

Connected multiple cells are enclosed in a metallic case, and terminals are attached to form a module. Then, the connected multiple modules with a sensor and a controller are enclosed in a case to form a battery pack.

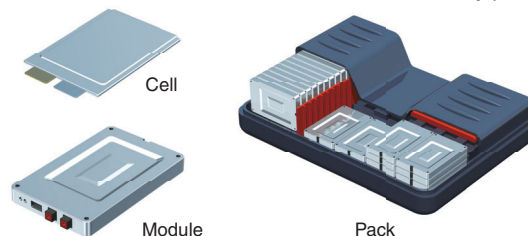

Cell

Module

Pack

### 3 Slitting

The electrode sheet and separator are cut to the cell width.

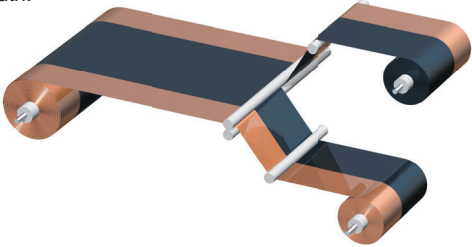

### 6 Welding cell lid and pouring electrolytic solution

The electrode and lid are laser-welded, and then the entire periphery of the cell case and lid is welded. Electrolytic solution is poured into the cell.

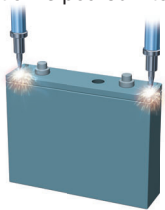

Welding cell lid

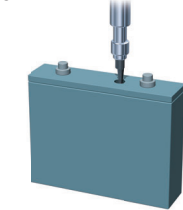

Pouring electrolytic solution

### 7 Pre-charging and welding infusion plug

Pre-charging (formation charging) is performed to remove the gas generated in the initial charging process, and then the infusion plug is welded to seal the cell.



Pre-charging

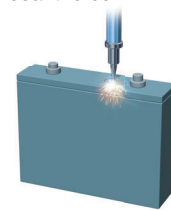

Welding infusion plug

### 6 Tab welding and lamination

Current collecting tabs are welded to the laminated body. The laminated body is wrapped with armoring material.

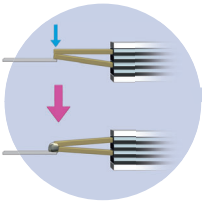

Tab welding

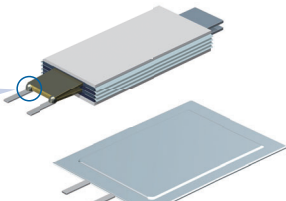

Lamination

### 7 Pre-charging and sealing cell

Pre-charging (formation charging) is performed to remove the gas generated in the initial charging process, and then heat is applied to seal the cell.

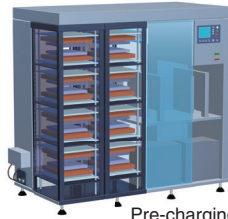

Pre-charging

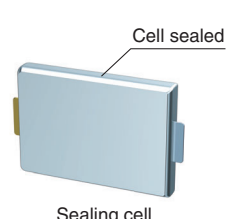



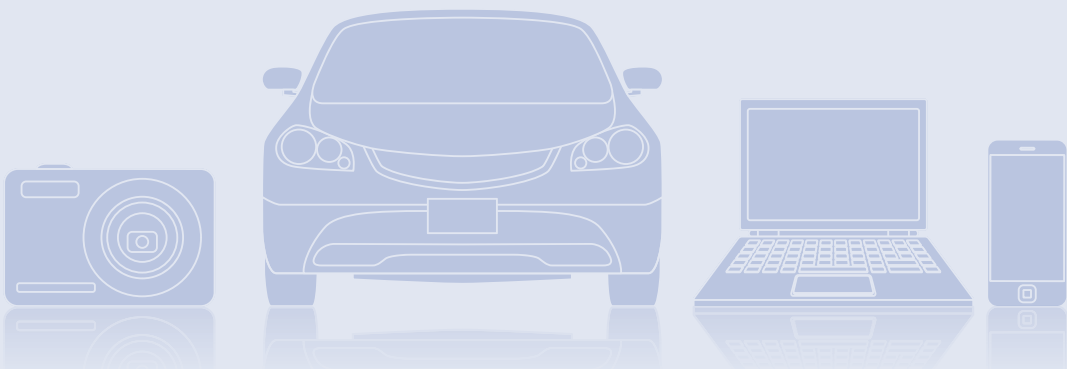





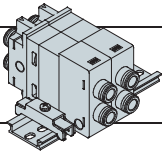



Sealing cell





# 25A- Series Applicable Products

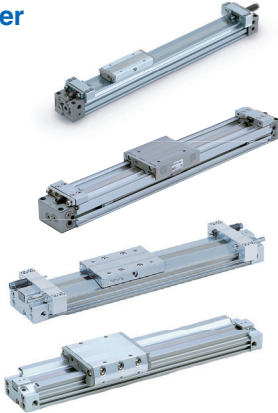
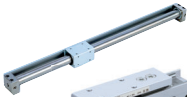
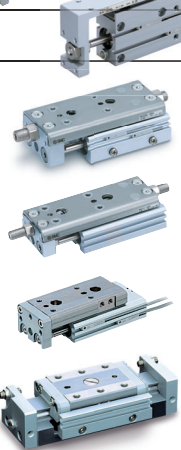





Description		25A- Series	
		Model (Type)	Page
Directional Control Valves	<b>5-Port Solenoid Valve</b> 	25A-JSY3000 (Plug-in connector connecting base)	p. 14-1
		25A-JSY3000 (Non plug-in metal base)	p. 14-11
		25A-SY5000 (Plug-in connector connecting base)	p. 15
		25A-SY5000, 7000	p. 36
		25A-VQ2000, 4000 (W)	p. 43
		25A-SQ2000	p. 56
		25A-VQZ1000	p. 61
	<b>Separate Type Double Check Block</b> 	25A-VQ1000, 2000 (Double check block)	p. 65
	<b>3-Port Solenoid Valve</b> 	25A-VP342, 542, 742 (Body ported)	p. 66
		25A-VP344, 544, 744 (Base mounted)	p. 67
		25A-VP500, 700 (Safety Standard ISO 13849-1)	p. 68
		25A-VT317	p. 69
		25A-VG342	p. 70
	<b>5-Port Air Operated Valve</b> 	25A-SYA5000, 7000	p. 71
<b>3-Port Air Operated Valve</b> 	25A-SYJA500, 700	p. 72	
<b>Finger Valve</b> 	25A-VHK-A	p. 73-1	
	25A-VHK	p. 74	
<b>Conforming to OSHA Standard Pressure Relief 3-Port Valve with Locking Holes</b> 	25A-VHS20(W), 30(W), 40(W), 50(W)-D	p. 75-1	
	25A-VHS20, 30, 40, 50	p. 75	
	25A-VHS2510, 3510, 4510, 5510	p. 76	
Air Cylinders	<b>Air Cylinder</b> 	25A-CJP2 (Standard)	p. 76-1
		25A-CJ2 (Standard)	p. 77
		25A-CJ2K (Standard)	p. 77-1
		25A-CBJ2 (With end lock)	p. 78
		25A-CM2 (Standard)	p. 79
		25A-CG1 (Standard)	p. 80
		25A-CBG1 (With end lock)	p. 81
		25A-MB (Standard)	p. 82
		25A-CA2 (Standard)	p. 83
		25A-CS2 (Standard)	p. 84
		Compact Air Cylinders	<b>Mini Free Mount Cylinder</b> 
<b>Free Mount Cylinder</b> 	25A-CU (Standard)		p. 88
	25A-CUK (Non-rotating rod)		p. 89

Description		25A- Series	
		Model (Type)	Page
Compact Air Cylinders	<b>Compact Cylinder</b> 	25A-CQS (Standard)	p. 90
		25A-CQSW (Standard, Double rod)	p. 91
		25A-CQS□S (Anti-lateral load)	p. 92
		25A-CQ2 (Standard)	p. 93
		25A-CQ2W (Standard, Double rod)	p. 94
		25A-CQ2 (Large bore size)	p. 95
		25A-CQ2 (Long stroke)	p. 96
		25A-CQ2□S (Anti-lateral load)	p. 97
		25A-CBQ2 (With end lock)	p. 98
Rodless Cylinders	<b>Mechanically Jointed Rodless Cylinder</b> 	25A-MY1B (Basic)	p. 99
		25A-MY1M (Slide bearing guide type)	p. 99-1
		25A-MY1C (Cam follower guide)	p. 100
		25A-MY1H (Linear guide)	p. 101
		25A-MY2C (Cam follower guide)	p. 101-1
		25A-MY2H/HT (Linear guide)	p. 102
		25A-MY3A (Basic short type, Rubber bumper)	p. 103
		25A-MY3B (Basic standard type, Air cushion)	p. 103
		25A-MY3M (Slide bearing guide type)	p. 104
Magnetically Coupled Rodless Cylinder		25A-CY3B (Basic)	p. 105
		25A-CY3R (G) (Direct mount)	p. 106
Table Cylinders	<b>Compact Slide</b> <b>Air Slide Table</b> 	25A-MXH (Recirculating linear guide)	p. 107
		25A-MXS (Cross roller guide)	p. 108
		25A-MXQ□A (Recirculating linear guide/Double-ported type)	p. 109
		25A-MXQ□B (Recirculating linear guide/Low thrust with high rigidity type)	p. 110
		25A-MXQ□C (Recirculating linear guide/Single side-ported type)	p. 111
		25A-MXQ□ (Recirculating linear guide/Height interchangeable type)	p. 112
		25A-MXQ (Recirculating linear guide)	p. 113
		25A-MXW (Recirculating linear guide)	p. 114
		25A-MXP (Recirculating linear guide)	p. 115
Guide Cylinders	<b>Compact Guide Cylinder</b> 	25A-MGPM (Slide bearing)	p. 116
		25A-MGPL (Ball bushing bearing)	p. 116
		25A-MGPM (Slide bearing, Air cushion type)	p. 117
		25A-MGPL (Ball bushing bearing, Air cushion type)	p. 117
	<b>Guide Cylinder</b> 	25A-MGGL (Ball bushing bearing)	p. 121

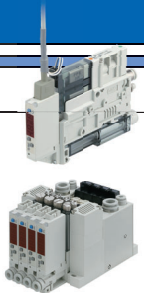
Description		25A- Series	
		Model (Type)	Page
Guide Cylinders	Slide Unit	25A-CXWM (Slide bearing)	p. 118
	Dual Rod Cylinder	25A-CXSJM (Slide bearing)	p. 119
		25A-CXSJL (Ball bushing bearing)	p. 119
		25A-CXSM (Slide bearing)	p. 120
		25A-CXSL (Ball bushing bearing)	p. 120
Clamp/ Stopper Cylinders	Rotary Clamp Cylinder	25A-MK (Standard)	p. 122
	Stopper Cylinder/ Fixed Mounting Height	25A-RSQ (Standard)	p. 123
	Heavy Duty Stopper Cylinder	25A-RSH (Standard)	p. 124
Related Products	Shock Absorber	25A-RJ (Soft type)	p. 125
		25A-RJ (Short stroke type)	p. 126
		25A-RB (Standard)	p. 127
		25A-RBC (Standard)	p. 127
	Floating Joint	25A-JA (Standard/80, 100 only)	p. 128
		25A-JB (For compact cylinders)	p. 128
		25A-JS (Stainless steel type)	p. 128
	Simple Joint for CQ2	YA (Type A mounting bracket)	*1
		YB (Type B mounting bracket)	*1
YU (Joint)		*1	
Rotary Actuators	Rotary Table	25A-MSUB (Vane type)	p. 129
		25A-MSQ (Rack & Pinion type)	p. 130
		25A-MSQ-X251 (Rack & Pinion type, With vacuum port)	p. 130
	3-Position Rotary Table	25A-MSZA (High precision type)	p. 132
		25A-MSZB (Basic type)	p. 132
Air Grippers	Parallel Type Air Gripper	25A-MHZ2 (Standard)	p. 133
		25A-MHZL2 (Long stroke)	p. 134
		25A-MHZJ2 (With dust cover)	p. 135
		25A-MHZJ2-X6100 (With dust cover type)	p. 135
		25A-MHZL2-X5955 (Long stroke, With dust cover)	p. 135
		25A-MHF2 (Low profile type)	p. 136
		25A-MHL2 (Wide type)	p. 137
		25A-MHS□ (3-finger, 4-finger)	p. 138
		25A-MHSJ3 (3-finger, With dust cover)	p. 139
		25A-MHY2 (180° Angular type)	p. 140
		25A-MHW2	p. 140-1











\*1 Standard products: Standard products are copper (Cu) and zinc (Zn) free. Refer to the **Catalogue** at [www.smc.eu](http://www.smc.eu) for details.



Description		25A- Series		
		Model (Type)	Page	
Vacuum Equipment		Vacuum Ejector	25A-ZK2 (Vacuum unit) Single unit only	p. 141
		Space Saving Vacuum Ejector	25A-ZQ (Ejector unit) Single unit/Manifold	p. 145
			25A-ZQ (Vacuum pump unit) Single unit/Manifold	p. 149
			ZH□□DA (Body ported) (Only the models without connection threads)	*1
			ZH□□BA (Box type) (Only the models without connection threads)	*1
	In-line Type Vacuum Ejector	ZU□□A (In-line type) (Only the models without connection threads)	*1	
	In-line Air Filter	ZFC (With One-touch fittings)	*1	
	Vacuum Pad	ZP (Pad only)	*1	
Vacuum Regulator	25A-IRV	p. 152-1		
Adsorption Plate	SP	*1		
Air Preparation Equipment		Membrane Air Dryer	25A-IDG (Single unit/Standard dew point -40 °C/-60 °C specifications)	p. 153
		Air Preparation Filter	25A-AFF (Main line filter)	p. 155
			25A-AM (Mist separator)	p. 156
			25A-AMD (Micro mist separator)	p. 157
			25A-AMH (Micro mist separator with pre-filter)	p. 158
Clean Air Filters		Clean Air Filter	SFD100	*1
			SFD200	*1
			25A-AMP (Exhaust cleaner for clean room)	p. 159
			SFE (Clean exhaust filter)	*1
Modular F.R.L./ Pressure Control Equipment		Modular F.R.L. Units	25A-AC□B-D, AC□C-D, AC□D-D	*2
			25A-AC□B-A, AC□C-A, AC□D-A	*2
		Air Filter Separator	25A-AF-D (Air filter)	p. 160-1
			25A-AFM-D (Mist separator)	p. 161-1
			25A-AFD-D (Micro mist separator)	p. 161-1
			25A-AF-A (Air filter)	p. 160
			25A-AFM-A (Mist separator)	p. 161
			25A-AFD-A (Micro mist separator)	p. 161
		Regulator	25A-AR-D (Regulator)	p. 162-1
			25A-AR□□K-D (Regulator with backflow function)	p. 162-1
			25A-AW-D (Filter regulator)	p. 163-1
			25A-AW□□K-D (Filter regulator with backflow function)	p. 163-1
			25A-AR-B (Regulator)	p. 162
			25A-AR□□K-B (Regulator with backflow function)	p. 162
			25A-AW-B (Filter regulator)	p. 163
	25A-AW□□K-B (Filter regulator with backflow function)	p. 163		

\*1 Standard products: For the standard model, copper (Cu) and zinc (Zn) are not used as main components in the metal materials. Refer to the **Catalogue** at [www.smc.eu](http://www.smc.eu) for details.

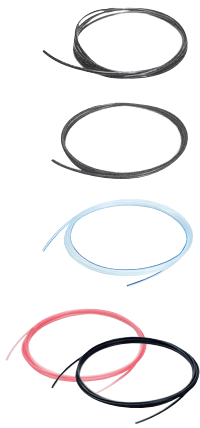
\*2 Available as simple specials. Please contact your local sales representative for more details.









Description		25A- Series	
		Model (Type)	Page
Modular F.R./ Pressure Control Equipment	<b>Booster Regulator</b> 	25A-VBA*4	p. 166
		25A-VBAT (Air tank)	p. 167
	<b>Pressure Gauge</b> 	G43-10-01-X300 (Stud, Bourdon tube, Internal parts: Stainless steel)	*2
		G46-SRB (Only external parts and wetted parts are made of stainless steel.)	*3
Flow Control Equipment/Fittings	<b>Stainless Steel Speed Controller</b> 	AS-FG (Elbow/Universal/In-line type)	*1
	<b>Speed Controller with Indicator</b> 	AS-FSG (Elbow type)	*1
		AS-FPG (Elbow type)	*1
	<b>Quick Exhaust Valve</b> 	25A-AQ240F, 340F (Built-in One-touch fittings)	p. 168
	<b>Check Valve</b> 	25A-AKH (With One-touch fittings)	p. 169
	<b>One-touch Fittings</b> 	KQ2 (One-touch fittings) (Only the type without a connection thread)	*1
	<b>Rectangular Multi-connector</b>	25A-KDM (Rectangular multi-connector)	p. 170
	<b>Stainless Steel Fittings</b> 	KG (One-touch fittings)	*1
		KPG (One-touch fittings)	*1
		KQG2 (One-touch fittings)	*1
		KQ2-G (Stainless steel)	*1
KFG2 (Insert fittings)		*1	
MS (Miniature fittings)		*1	
KKA (S Couplers stainless steel type)		*1	
Tubing	<b>Tubing</b> 	T (Nylon)	*1
		TS (Soft nylon)	*1
		TU (Polyurethane)	*1
		TA□ (Antistatic)	*1
		TL (Fluoropolymer)	*1
		TH (FEP)	*1
		TD (Soft fluoropolymer)	*1
		TPS (Soft polyolefin)	*1
IDK (Moisture control tube)	*1		
Detection Switches	<b>Pressure Switch</b> 	25A-ZSE20(F)/ISE20 (3-screen display high-precision)	p. 171
		25A-ZSE20A(F)/ISE20A (3-screen display high-precision)	p. 172
		25A-ZSE20B(F)/ISE20B (3-screen display high-precision)	p. 173
		25A-ZSE20C(F)/ISE20C(H) (3-screen display high-precision, for general fluids)	p. 174

\*1 Standard products: For the standard model, copper (Cu) and zinc (Zn) are not used as main components in the metal materials. Refer to the **Catalogue at [www.smc.eu](http://www.smc.eu)** for details.

\*2 Copper (Cu) and zinc (Zn) are not used as main components in the metal materials. Please contact your local sales representative for more details.

\*3 Standard products: Aside from the external parts and wetted parts, copper (Cu) and zinc (Zn) are used as main components in the metal materials. Refer to the **Catalogue at [www.smc.eu](http://www.smc.eu)** for details.

\*4 Pressure gauge mounting: The G43-10-01-X300/G46-SRB pressure gauge cannot be mounted directly to the booster regulator as it will interfere with the booster regulator (25A-VBA10A) handle or the other pressure gauge (for the 25A-VBA20A/40A). In order to mount the pressure gauge, piping which does not cause any interference must be prepared separately.

Description		25A- Series	
		Model (Type)	Page
Detection Switches	<b>Flow Switch</b> 	25A-PFMB7 (2-colour display)	p. 175
		25A-PFM5 (2-colour display, Remote sensor unit)	p. 177
		25A-PFM3 (Monitor for air)	p. 178
		25A-PF3W (3-colour display, Monitor for water)	p. 179
		25A-PFM7 (2-colour display, Integrated display)	p. 180
		25A-PF3W (3-colour display, for water)	p. 181
		25A-PF3W (3-colour display, for PVC piping)	p. 182
		Fluid Control Equipment	<b>Direct Operated 2-Port Solenoid Valve</b> 
25A-VX2 (For water/oil/medium vacuum)	p. 184		
<b>Pilot Operated 2-Port Solenoid Valve</b> 	25A-VXD (For air)		p. 185
	25A-VXD (For water)		p. 186
<b>Zero Differential Pressure Type Pilot Operated 2-Port Solenoid Valve</b> 	25A-VXZ (For air)		p. 187
	25A-VXZ (For water)		p. 188
Process Gas Equipment	<b>Diaphragm Valve for Ultra High Purity</b>  <b>Diaphragm Valves for General Applications</b> 	AZ3542 & 4542□25A (Air operated type)	p. 188-1
		AK3542 & 4542□25A (Air operated type)	p. 188-3
Electric Actuators	<b>Electric Actuator</b> 	25A-LEFS (Slider type/Step motor, Servo motor: Applicable to the LEC□)	p. 189
		25A-LEFS (Slider type/Step motor: Applicable to the JXC□)	p. 191
		25A-LEFS (Slider type/AC servo motor: Applicable to the LECS□)	p. 193
		25A-LEFS (Slider type/AC servo motor: Applicable to the LECY□)	p. 194
		25A-LEJS (High rigidity slider type/AC servo motor: Applicable to the LECS□)	p. 195
		25A-LEJS (High rigidity slider type/AC servo motor: Applicable to the LECY□)	p. 196
		25A-LEY (Rod type/Step motor, Servo motor: Applicable to the LEC□)	p. 197
		25A-LEY (Rod type/Step motor: Applicable to the JXC□)	p. 199
		25A-LEY (Rod type/AC servo motor: Applicable to the LECS□)	p. 201
		25A-LEY (Rod type/AC servo motor: Applicable to the LECY□)	p. 203
Auto Switches	<b>Solid State Auto Switch</b> 	D-M9□□-900	From p. 205
		D-F8□-900	
		D-Y7□□-900	
		D-G59, G5P, K59-900	
		D-F79, F7P, J79-900	
		D-F7□V-900	
	<b>Reed Auto Switch</b> 	D-A90-900	From p. 205
		D-Z80-900	
		D-E73A, E76A, E80A	

### 25A-series grease pack\*1 applicable models

\*1 Air cylinders (Except guide unit). For other models, please contact your local sales representative.

Grease pack part no.	Quantity
GR-D-005	5 g
GR-D-010	10 g
GR-D-100	100 g

Contained in a plastic container.



**Special Products** (Please contact your local sales representative for more details.)

Description	Model (Type)	
<b>Directional Control Valves</b> <b>3-Port Solenoid Valve/ Residual Pressure Release Valve with Detection of Main Valve Position</b> (Safety Standard ISO 13849-1 Certified) 	VG342-X87	
<b>Air Cylinders</b>	<b>Air Cylinder With End Lock</b> 	CBM2
	<b>Cylinder with Lock</b> 	MBB
	<b>Cylinder with Lock</b>	CNG□N
	<b>Compact Cylinder with Lock</b> 	CNA2□N
	<b>Stopper Cylinder</b> 	CLQ
<b>Heavy Duty Stopper Cylinder</b> 	RSQ  RS2H	
<b>Vacuum Equipment</b>	<b>Vacuum Pad</b> 	ZP□
	<b>Non-contact Gripper</b> 	XT661
	<b>Vacuum Regulator</b> 	IRV (Standard)
<b>High Vacuum Equipment</b>	<b>Aluminium High Vacuum Angle Valve</b> 	XLA (Normally closed) XLC (Double acting)

# Related Products

Consult with SMC for "Copper (Cu) and Zinc (Zn) Restrictions" products.

## 1 Antistatic Equipment

Vacuum

Static electricity

Antistatic performance achieved through conductive measures for a reduction in static-related trouble.

**Actuators** • Antistatic Air Cylinder (Made to order) ..... *CM2-X1051 Series*

**Vacuum Equipment** • Vacuum Pad ..... *ZP Series*

### Fittings and tubing

- Antistatic One-touch Fittings ..... *KA Series*
- Miniature Fittings/Stainless Steel 316 ..... *MS Series*
- Miniature Fittings ..... *M Series*
- Antistatic Tubing ..... *TA□ Series*

### Flow Control Equipment

- Antistatic Speed Controller (Made to order) ..... *AS-X260 Series*



## 2 Static Neutralization Equipment

Static electricity

Ions generated by corona discharge neutralize static electricity.

- Ionizer/Bar Type ..... *IZS4□ Series*
- Bar Type Ionizer **Separate Controller** ..... *IZT4□ Series*
- Ionizer ..... *IZS31 Series*
- Nozzle Type Ionizer ..... *IZN10E Series*
- Fan Type Ionizer ..... *IZF□ Series*

**Measurement Equipment** Measures the electrostatic potential.

- Electrostatic Sensor ..... *IZD10/IZE11 Series*
- Handheld Electrostatic Meter ..... *IZH10 Series*

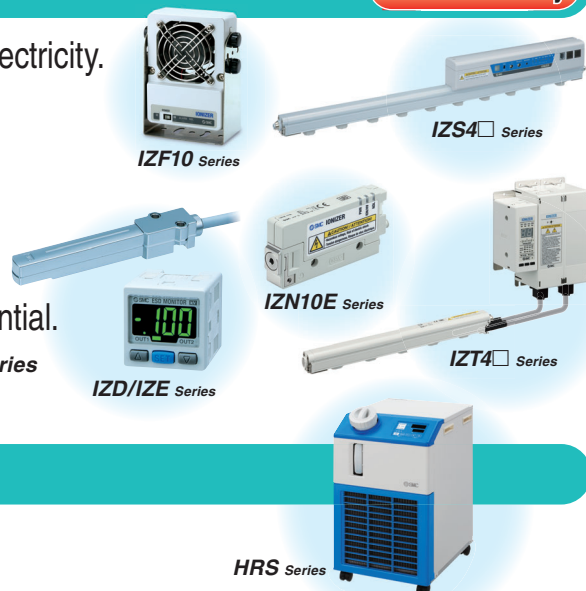

## 3 Temperature Control Equipment

- Thermo-chiller/Standard Type ..... *HRS Series*



## 4 Electric Actuators

- Electric Actuator/Slider Type ..... *LEFB Series*
- Electric Actuator/Low Profile Slider Type ..... *LEM Series*
- Electric Actuator/Guide Rod Slider ..... *LEL Series*
- Electric Slide Table ..... *LES Series*
- Electric Actuator/Miniature Rod Type /Miniature Slide Table Type ..... *LEPY/LEPS Series*
- Electric Rotary Table ..... *LER Series*
- Electric Gripper ..... *LEH□ Series*
- Motorless Type Electric Actuator ..... *LE□ Series*

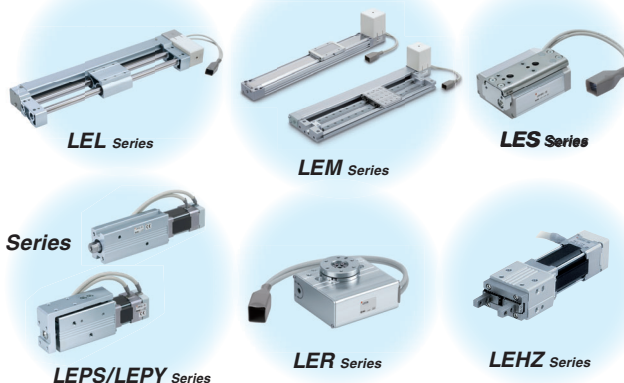

## 5 High Purity Chemical Liquid Valves

- High Purity Chemical Liquid Valve/Air Operated Type ..... *LVC/LVA/LVH Series*



# Plug-in Connector Connecting Base

## D-sub Connector

Type 10  
Side Ported

# 25A-JSY3000 Series



Internal Pilot

### How to Order Manifolds

25A-JJ5SY3-10F1-05D-C6

1 2 3 4 5 6 7 8 9

Series compatible with secondary batteries

#### 1 Series

3	JSY3000
---	---------

#### 2 Type

10	Side ported
----	-------------

#### 3 Connector type

F: D-sub connector  
Connector entry direction adjustable

<IP40>  
(25 pins)

#### 4 Connector entry direction

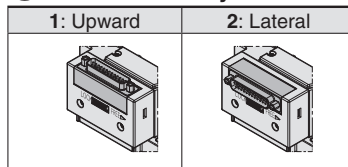

\* The connector entry direction for connector types "FW," "FC," and "P□C" cannot be rotated. If it is necessary to change, order connector block assembly and SUP/EXH block assembly separately.

#### 5 Valve stations

F: D-sub connector (25 pins)

Symbol	Stations	Note
02	2 stations	Double wiring*1
⋮	⋮	
12	12 stations	
02	2 stations	Specified layout*2 (Up to 16 solenoids available)
⋮	⋮	
16	16 stations	

\*1 Double wiring: 2-position single, double, 3-position, and 4-position valves can be used on all manifold stations. Use of a 2-position single solenoid will result in an unused control signal. If this is not desired, order with a specified layout.

\*2 Specified layout: Indicate the wiring specifications on the manifold specification sheet. (Note that 2-position double, 3-position, and 4-position valves cannot be used where single wiring has been specified.)

\* This also includes the number of blanking plates.

#### 6 P, E port entry

U	U side (2 to 10 stations)
D	D side (2 to 10 stations)
B	Both sides (2 to 16 stations)

#### 7 SUP/EXH block assembly

—	Internal pilot
S	Internal pilot, Built-in silencer

\* 3 / 5 (E) port is plugged for the built-in silencer type.

#### 8 A, B port size (Metric/One-touch fitting)

Symbol	A, B port	
C6	Ø 6	
C8	Ø 8	
CM*1	Straight port, mixed sizes	
P, E port size (One-touch fittings)		Ø 10

\*1 Indicate the sizes on the manifold specification sheet in the case of "CM."

#### 9 Mounting and Option

Symbol	Mounting
—	Direct mounting
D□	DIN rail mounting

#### DIN Rail Option

Symbol	Option	Note
—	DIN rail mounting (With DIN rail)	
0	DIN rail mounting (Without DIN rail)	
3	For 3 stations	Specify a longer rail than the standard length.
⋮	⋮	
16	For 16 stations	

\* Enter the number of stations inside □ when it is larger than the number of valve stations. (Refer to "DIN Rail Option" shown on the above.)

\* Refer to the **Catalogue at [www.smc.eu](http://www.smc.eu)** for the fixation of DIN rail mounting type manifold.

\* The 25A-series specifications and dimensions are the same as those of the standard model.



## How to Order Manifold Assembly

### Example (25A-JJ5SY3-10F1-□)

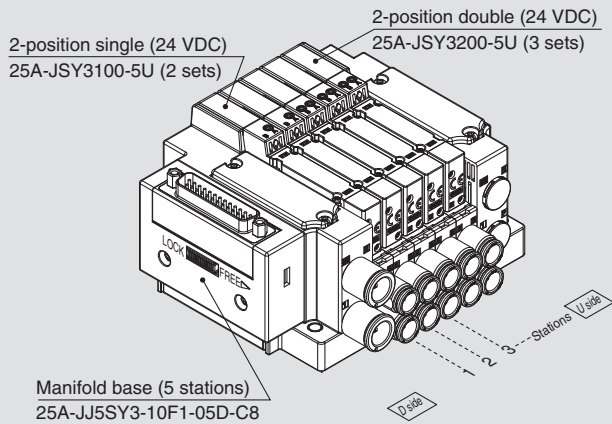

25A-JJ5SY3-10F1-05D-C8 ...1 set (Type 10 5-station manifold base part no.)  
 \* 25A-JSY3100-5U .....2 sets (2-position single part no.)  
 \* 25A-JSY3200-5U .....3 sets (2-position double part no.)  
 → The asterisk denotes the symbol for the assembly.  
 Prefix it to the part numbers of the valve, etc.

- The valve arrangement is numbered as the 1st station from the D side.
- Under the manifold part number, state the valves to be mounted in order from the 1st station as shown in the figure. If the arrangement becomes complicated, specify on a manifold specification sheet.

### Internal Pilot

## How to Order Valves (With mounting screw)

Refer to the Catalogue at [www.smc.eu](http://www.smc.eu) for valve specifications.

## 25A-JSY3000 Series

**25A - JSY 3 1 00 - 5 Z**

① ② ③ ④ ⑤ ⑥

• Series compatible with secondary batteries • Base mounted



Made to Order

Specification

With power saving circuit (Continuous duty type): 0.1 W

### ① Series

3	JSY3000
---	---------

### ② Type of actuation

1	2-position	Single
2		Double
3	3-position	Closed centre
4		Exhaust centre
5		Pressure centre
A	4-position dual 3-port	N.C./N.C.
B		N.O./N.O.
C		N.C./N.O.

### ③ Pilot valve exhaust method

0	Pilot valve individual exhaust
---	--------------------------------

### ④ Rated voltage

5	24 VDC
---	--------

### ⑥ Manual override

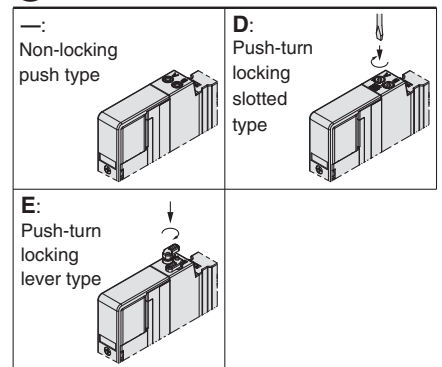

### ⑤ Light/surge voltage suppressor and common specification

Symbol	With light	Surge voltage suppressor	Common specification
U			Non-polar
Z	●	●	Positive common
NZ			Negative common

\* When non-polar common specification type is selected, take measures to prevent surge voltage. For details, refer to the Catalogue at [www.smc.eu](http://www.smc.eu).

\* **When ordering a valve individually, the base gasket is not included.**

Since the base gasket is attached to the manifold, please order the base gasket separately if it is needed for maintenance service.

Refer to the Catalogue at [www.smc.eu](http://www.smc.eu) for base gasket part numbers.

### ⚠ Caution

If the valve will be continuously energised, please be sure to use the power saving circuit (continuous duty type). Refer to Made to Order.

\* The 25A- series specifications and dimensions are the same as those of the standard model.

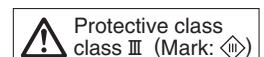

# Plug-in Connector Connecting Base

## Terminal Block Box

Type 10  
Side Ported

# 25A-JSY3000 Series



Internal Pilot

### How to Order Manifolds

25A - JJ5SY 3 - 10 T - 05 D □ - C6 □

1
2
3
4
5
6
7
8

Series compatible with secondary batteries

#### 1 Series

3	JSY3000
---	---------

#### 2 Type

10	Side ported
----	-------------

#### 3 Wiring

T	Terminal block box
---	--------------------

#### 4 Valve stations

T: Terminal block box

Symbol	Stations	Note
02	2 stations	Double wiring*1
⋮	⋮	
10	10 stations	Specified layout*2 (Up to 16 solenoids available)
02	2 stations	
⋮	⋮	
16	16 stations	

\*1 Double wiring: 2-position single, double, 3-position, and 4-position valves can be used on all manifold stations. Use of a 2-position single solenoid will result in an unused control signal. If this is not desired, order with a specified layout.

\*2 Specified layout: Indicate the wiring specifications on the manifold specification sheet. (Note that 2-position double, 3-position, and 4-position valves cannot be used where single wiring has been specified.)

\*3 This also includes the number of blanking plates.

#### 5 P, E port entry

U	U side (2 to 10 stations)
D	D side (2 to 10 stations)
B	Both sides (2 to 16 stations)

#### 6 SUP/EXH block assembly

—	Internal pilot
S	Internal pilot, Built-in silencer

\* 3/5(E) port is plugged for the built-in silencer type.

\* When the built-in silencer type is used, keep the exhaust port from coming in direct contact with water or other liquids.

#### 7 A, B port size (Metric/One-touch fitting)

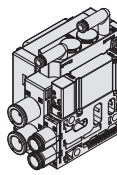
Symbol	A, B port		
C6	Straight	∅ 6	
C8		∅ 8	
CM*1		Straight port, mixed sizes	
P, E port size (One-touch fittings)			∅ 10

\*1 Indicate the sizes on the manifold specification sheet in the case of "CM."

#### 8 Mounting and Option

Symbol	Mounting
—	Direct mounting
D□	DIN rail mounting

\* Enter the number of stations inside □ when it is larger than the number of valve stations. (Refer to "DIN Rail Option" shown below.)

\* Refer to the **Catalogue at [www.smc.eu](http://www.smc.eu)** for the fixation of DIN rail mounting type manifold.

##### DIN Rail Option

—	DIN rail mounting (With DIN rail)	
0	DIN rail mounting (Without DIN rail)	
3	For 3 stations	Specify a longer rail than the standard length.
⋮	⋮	
16	For 16 stations	

\* The 25A- series specifications and dimensions are the same as those of the standard model.

## How to Order Manifold Assembly

### Example (25A-JJ5SY3-10TC-□)

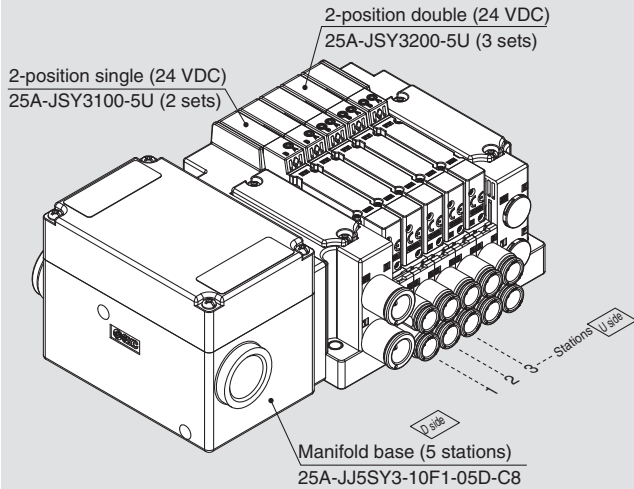

25A-JJ5SY3-10TC-05D-C8 .... 1 set (Type 10 5-station manifold base part no.)

\* 25A-JSY3100-5U ..... 2 sets (2-position single part no.)

\* 25A-JSY3200-5U ..... 3 sets (2-position double part no.)

→ The asterisk denotes the symbol for the assembly. Prefix it to the part numbers of the valve, etc.

- The valve arrangement is numbered as the 1st station from the D side.
- Under the manifold part number, state the valves to be mounted in order from the 1st station as shown in the figure. If the arrangement becomes complicated, specify on a manifold specification sheet.

### Internal Pilot

## How to Order Valves (With mounting screw)

Refer to the Catalogue at [www.smc.eu](http://www.smc.eu) for valve specifications.

## 25A-JSY3000 Series

**25A - JSY 3 1 00 - 5 Z**

① ② ③ ④ ⑤ ⑥

• Series compatible with secondary batteries

• Base mounted



Made to Order

Specification

With power saving circuit (Continuous duty type): 0.1 W

### ① Series

3	JSY3000
---	---------

### ③ Pilot valve exhaust method

0	Pilot valve individual exhaust
---	--------------------------------

### ④ Rated voltage

5	24 VDC
---	--------

### ② Type of actuation

1	2-position	Single
2		Double
3	3-position	Closed centre
4		Exhaust centre
5		Pressure centre
A	4-position dual 3-port	N.C./N.C.
B		N.O./N.O.
C		N.C./N.O.

### ⑤ Light/surge voltage suppressor and common specification

Symbol	With light	Surge voltage suppressor	Common specification
U			Non-polar
Z	●	●	Positive common
NZ			Negative common

\* When non-polar common specification type is selected, take measures to prevent surge voltage. For details, refer to the Catalogue at [www.smc.eu](http://www.smc.eu).

### ⑥ Manual override

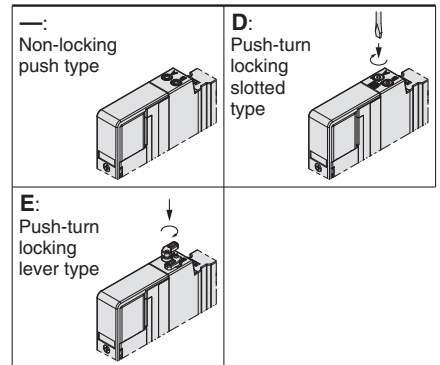

## ⚠ Caution

If the valve will be continuously energised, please be sure to use the power saving circuit (continuous duty type). Refer to Made to Order.

\* **When ordering a valve individually, the base gasket is not included.**

Since the base gasket is attached to the manifold, please order the base gasket separately if it is needed for maintenance service.

Refer to the Catalogue at [www.smc.eu](http://www.smc.eu) for base gasket part numbers.

\* The 25A- series specifications and dimensions are the same as those of the standard model.

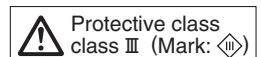



# Plug-in Connector Connecting Base

EX260

Type 10  
Side Ported

# 25A-JSY3000 Series



Internal Pilot

## How to Order Manifolds

25A - JJ5SY 3 - 10 S QA - 05 D □ - C6 □

Series compatible with secondary batteries

### 1 Series

3	JSY3000
---	---------

### 3 SI unit (Output polarity, Protocol, Number of outputs, Communication connector)

Symbol (Output polarity)		Protocol	Number of outputs	Communication connector
Positive common (NPN)	Negative common (PNP)			
0*1 Without SI unit				
QA	QAN	DeviceNet™	32	M12
QB	QBN		16	
NA	NAN	PROFIBUS DP	32	M12
NB	NBN		16	
VA	VAN	CC-Link	32	M12
VB	VBN		16	
DA	DAN	EtherCAT	32	M12
DB	DBN		16	
FA	FAN	PROFINET	32	M12
FB	FBN		16	
EA	EAN	EtherNet/IP™	32	M12
EB	EBN		16	

\*1 Without SI unit, the output polarity is decided by the SI unit used.

Ensure a match with the common specification of the valves to be used.

\* DIN rail cannot be mounted without SI unit.

### 7 A, B port size

(Metric/One-touch fitting)

Symbol	A, B port	
C6	Straight	Ø 6
C8		Ø 8
CM*1		Straight port, mixed sizes
P, E port size (One-touch fittings)		Ø 10

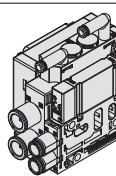

\*1 Indicate the sizes on the manifold specification sheet in the case of "CM."

### 2 Type

10	Side ported
----	-------------

### 5 P, E port entry

U	U side (2 to 10 stations)
D	D side (2 to 10 stations)
B	Both sides (2 to 16 stations)

### 6 SUP/EXH block assembly

—	Internal pilot
S	Internal pilot, Built-in silencer

\* 3/5(E) port is plugged for the built-in silencer type.

\* When the built-in silencer type is used, keep the exhaust port from coming in direct contact with water or other liquids.

### 4 Valve stations

In the case of the 32-output SI unit

Symbol	Stations	Note
02	2 stations	Double wiring*1
⋮	⋮	
16	16 stations	

In the case of the 16-output SI unit

Symbol	Stations	Note
02	2 stations	Double wiring*1
⋮	⋮	
08	8 stations	
02	2 stations	Specified layout*2 (Up to 16 solenoids available)
⋮	⋮	
16	16 stations	

\*1 Double wiring: 2-position single, double, 3-position, and 4-position valves can be used on all manifold stations.

Use of a 2-position single solenoid will result in an unused control signal. If this is not desired, order with a specified layout.

\*2 Specified layout: Indicate the wiring specifications on the manifold specification sheet. (Note that 2-position double, 3-position, and 4-position valves cannot be used where single wiring has been specified.)

\* This also includes the number of blanking plates.

\* For the product without the SI unit (S0), note the maximum number of solenoids of the SI unit that will be mounted. If the layout is specified, indicate it on the manifold specification sheet.

### 8 Mounting and Option

Symbol	Mounting
—	Direct mounting
D□	DIN rail mounting

\* Enter the number of stations inside □ when it is larger than the number of valve stations. (Refer to "DIN Rail Option" shown below.)

\* Refer to the Catalogue at [www.smc.eu](http://www.smc.eu) for the fixation of DIN rail mounting type manifold.

\* DIN rail mounting (D□) is not available for the product without the SI unit (S0).

#### DIN Rail Option

—	DIN rail mounting (With DIN rail)	
0	DIN rail mounting (Without DIN rail)	
3	For 3 stations	Specify a longer rail than the standard length.
⋮	⋮	
16	For 16 stations	

\* Refer to L3 of the dimensions for the DIN rail length and order separately. (Refer to the Catalogue at [www.smc.eu](http://www.smc.eu) for the DIN rail part number.)

\* The 25A-series specifications and dimensions are the same as those of the standard model.

For details about the EX260 Integrated Type (For Input/Output) Serial Transmission System, refer to the Catalogue at [www.smc.eu](http://www.smc.eu) and the Operation Manual. For details about part numbers of SI units to be mounted, refer to the Catalogue at [www.smc.eu](http://www.smc.eu). Please download the Operation Manual via SMC website, <https://www.smc.eu>

## How to Order Manifold Assembly

### Example (25A-JJ5SY3-10SNAN-□)

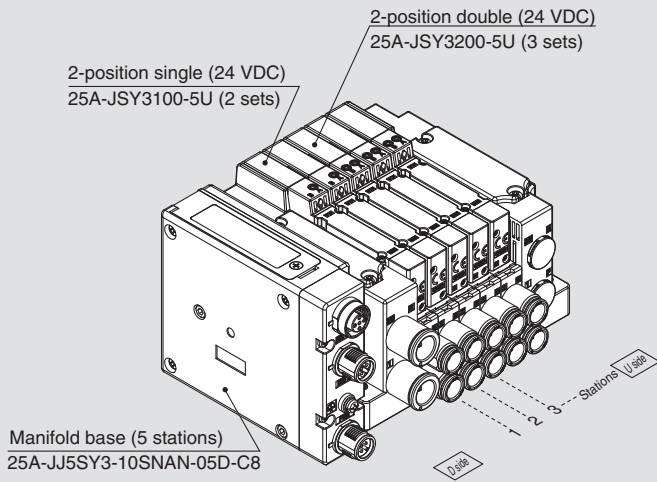

25A-JJ5SY3-10SNAN-05D-C8...1 set (Type 10 5-station manifold base part no.)

\* 25A-JSY3100-5U .....2 sets (2-position single part no.)

\* 25A-JSY3200-5U .....3 sets (2-position double part no.)

→ The asterisk denotes the symbol for the assembly. Prefix it to the part numbers of the valve, etc.

- The valve arrangement is numbered as the 1st station from the D side.
- Under the manifold part number, state the valves to be mounted in order from the 1st station as shown in the figure. If the arrangement becomes complicated, specify on a manifold specification sheet.

### Internal Pilot

## How to Order Valves (With mounting screw)

Refer to the **Catalogue** at [www.smc.eu](http://www.smc.eu) for valve specifications.

## 25A-JSY3000 Series

**25A - JSY 3 1 00 - 5 Z** □

1    2                    3    4    5    6



**Made to Order**

Specification

With power saving circuit (Continuous duty type): 0.1 W

- Series compatible with secondary batteries
- Base mounted

### 1 Series

3	JSY3000
---	---------

### 3 Pilot valve exhaust method

0	Pilot valve individual exhaust
---	--------------------------------

### 4 Rated voltage

5	24 VDC
---	--------

### 2 Type of actuation

1		Single
2	2-position	Double
3	3-position	Closed centre
4		Exhaust centre
5		Pressure centre
A	4-position dual 3-port	N.C./N.C.
B		N.O./N.O.
C		N.C./N.O.

### 5 Light/surge voltage suppressor and common specification

Symbol	With light	Surge voltage suppressor	Common specification
U	●	●	Non-polar
Z			Positive common
NZ			Negative common

- \* Select a valve from U or Z when the SI unit output polarity is — (positive common). Select a valve from U or NZ when the SI unit output polarity is N (negative common).
- \* When non-polar common specification type is selected, take measures to prevent surge voltage. For details, refer to the **Catalogue** at [www.smc.eu](http://www.smc.eu).

### 6 Manual override

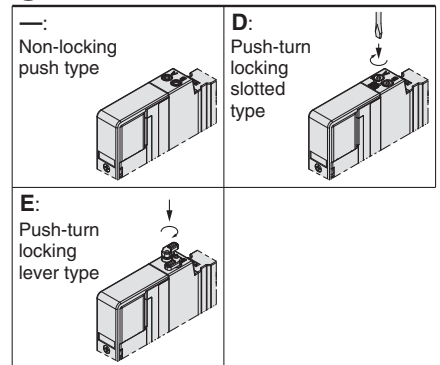

\* **When ordering a valve individually, the base gasket is not included.**

Since the base gasket is attached to the manifold, please order the base gasket separately if it is needed for maintenance service. Refer to the **Catalogue** at [www.smc.eu](http://www.smc.eu) for base gasket part numbers.

## Caution

If the valve will be continuously energised, please be sure to use the power saving circuit (continuous duty type). Refer to Made to Order.

\* The 25A- series specifications and dimensions are the same as those of the standard model.

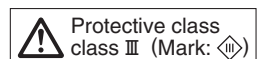

# Plug-in Connector Connecting Base

EX120

Type 10  
Side Ported

# 25A-JSY3000 Series



Internal Pilot

## How to Order Manifolds

25A-JJ5SY3-10S3Q-05D- - -

1
2
3
4
5
6
7
8

Series compatible with secondary batteries

### 1 Series

3	JSY3000
---	---------

### 2 Type

10	Side ported
----	-------------

### 3 SI unit

0	Without SI unit
Q	DeviceNet™ (Positive common NPN)
V	CC-Link (Positive common NPN)

\* Ensure a match with the common specification of the valve to be used.

### 5 P, E port entry

U	U side (2 to 10 stations)
D	D side (2 to 10 stations)
B	Both sides (2 to 16 stations)

### 6 SUP/EXH block

—	Internal pilot
S	Internal pilot, Built-in silencer

\* 3/5(E) port is plugged for the built-in silencer type.

### 7 A, B port size (Metric/One-touch fitting)

Symbol	A, B port	
C6	Straight	Ø 6
		Ø 8
CM*1	Straight port, mixed sizes	
P, E port size (One-touch fittings)		Ø 10

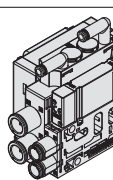

\*1 Indicate the sizes on the manifold specification sheet in the case of "CM."

### 8 Mounting and Option

Symbol	Mounting
—	Direct mounting
D□	DIN rail mounting

\* Enter the number of stations inside □ when it is larger than the number of valve stations. (Refer to "DIN Rail Option" shown below.)  
\* Refer to the **Catalogue at [www.smc.eu](http://www.smc.eu)** for the fixation of DIN rail mounting type manifold.

#### DIN Rail Option

—	DIN rail mounting (With DIN rail)	
0	DIN rail mounting (Without DIN rail)	
3	For 3 stations	Specify a longer rail than the standard length.
⋮	⋮	
16	For 16 stations	

\* If the DIN rail must be mounted without an SI unit, select D0. Refer to L3 of the dimensions for the DIN rail length and order separately. (Refer to the **Catalogue at [www.smc.eu](http://www.smc.eu)** for the DIN rail part number.)

### 4 Valve stations

Symbol	Stations	Note
02	2 stations	Double wiring*1
⋮	⋮	
08	8 stations	Specified layout*2 (Up to 16 solenoids available)
02	2 stations	
⋮	⋮	
16	16 stations	

\*1 Double wiring: 2-position single, double, 3-position, and 4-position valves can be used on all manifold stations. Use of a 2-position single solenoid will result in an unused control signal. If this is not desired, order with a specified layout.  
\*2 Specified layout: Indicate the wiring specifications on the manifold specification sheet. (Note that 2-position double, 3-position, and 4-position valves cannot be used where single wiring has been specified.)  
\* This also includes the number of blanking plates.

\* The 25A-series specifications and dimensions are the same as those of the standard model.

For details about the EX120 Integrated Type (For Output) Serial Transmission System, refer to the **Catalogue at [www.smc.eu](http://www.smc.eu)** and the Operation Manual. For details about part numbers of SI units to be mounted, refer to the **Catalogue at [www.smc.eu](http://www.smc.eu)**. Please download the Operation Manual via SMC website, <https://www.smc.eu>



## How to Order Manifold Assembly

### Example (25A-JJ5SY3-10S3Q-□)

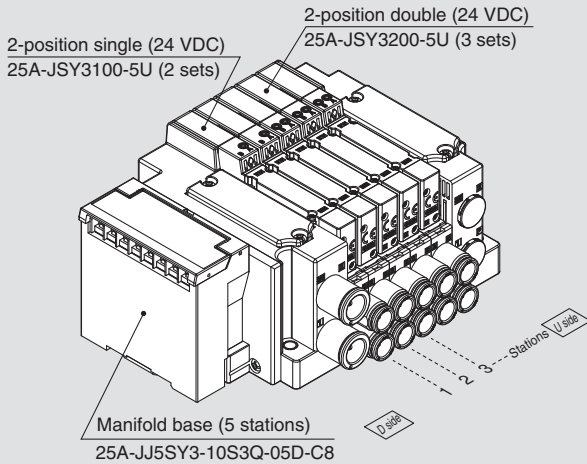

25A-JJ5SY3-10S3Q-05D-C8 ..1 set (Type 10 5-station manifold base part no.)

\* 25A-JSY3100-5U .....2 sets (2-position single part no.)

\* 25A-JSY3200-5U .....3 sets (2-position double part no.)

→ The asterisk denotes the symbol for the assembly. Prefix it to the part numbers of the valve, etc.

- The valve arrangement is numbered as the 1st station from the D side.
- Under the manifold part number, state the valves to be mounted in order from the 1st station as shown in the figure. If the arrangement becomes complicated, specify on a manifold specification sheet.

### Internal Pilot

## How to Order Valves (With mounting screw)

Refer to the Catalogue at [www.smc.eu](http://www.smc.eu) for valve specifications.

## 25A-JSY3000 Series

**25A - JSY 3 1 00 - 5 Z** □

1    2            3    4    5    6



**Made to Order**

Specification

With power saving circuit (Continuous duty type): 0.1 W

- Series compatible with secondary batteries
- Base mounted

### 1 Series

3	JSY3000
---	---------

### 3 Pilot valve exhaust method

0	Pilot valve individual exhaust
---	--------------------------------

### 4 Rated voltage

5	24 VDC
---	--------

### 2 Type of actuation

1		Single
2	2-position	Double
3		Closed centre
4	3-position	Exhaust centre
5		Pressure centre
A		N.C./N.C.
B	4-position	N.O./N.O.
C	dual 3-port	N.C./N.O.

### 5 Light/surge voltage suppressor and common specification

Symbol	With light	Surge voltage suppressor	Common specification
U	●	●	Non-polar
Z	●	●	Positive common

\* When non-polar common specification type is selected, take measures to prevent surge voltage. For details, refer to the **Catalogue at [www.smc.eu](http://www.smc.eu)**.

### 6 Manual override

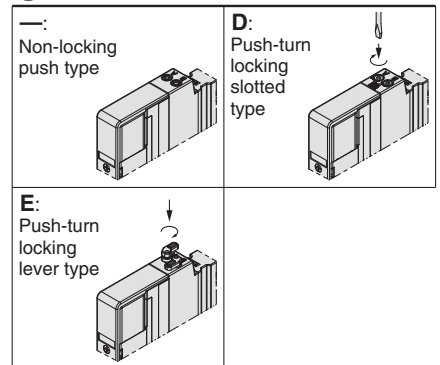

### ⚠ Caution

If the valve will be continuously energised, please be sure to use the power saving circuit (continuous duty type). Refer to Made to Order.

\* **When ordering a valve individually, the base gasket is not included.**

Since the base gasket is attached to the manifold, please order the base gasket separately if it is needed for maintenance service.

Refer to the **Catalogue at [www.smc.eu](http://www.smc.eu)** for base gasket part numbers.

\* The 25A- series specifications and dimensions are the same as those of the standard model.

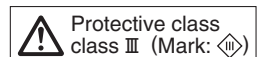

# 25A-JSY3000 Series Manifold Options

## Blanking plate assembly

(With two mounting screws)

Used when valve additions are expected or for maintenance. A structure is in place on the blanking plate to prevent the mounting screws from sliding.

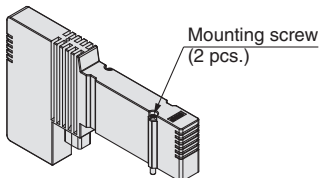

## How to Order Blanking Plate Assembly

**25A – JSY 3 1M – 26P – 1A**



## SI Unit Part Nos.

Description	SI unit part no.	Note
EX260 SI unit	<b>EX260-SPR1-X117</b>	PROFIBUS DP M12 connector, 32 outputs, Negative common (PNP)
	<b>EX260-SPR2-X117</b>	PROFIBUS DP M12 connector, 32 outputs, Positive common (NPN)
	<b>EX260-SPR3-X117</b>	PROFIBUS DP M12 connector, 16 outputs, Negative common (PNP)
	<b>EX260-SPR4-X117</b>	PROFIBUS DP M12 connector, 16 outputs, Positive common (NPN)
	<b>EX260-SDN1-X117</b>	DeviceNet™ M12 connector, 32 outputs, Negative common (PNP)
	<b>EX260-SDN2-X117</b>	DeviceNet™ M12 connector, 32 outputs, Positive common (NPN)
	<b>EX260-SDN3-X117</b>	DeviceNet™ M12 connector, 16 outputs, Negative common (PNP)
	<b>EX260-SDN4-X117</b>	DeviceNet™ M12 connector, 16 outputs, Positive common (NPN)
	<b>EX260-SEC1-X117</b>	EtherCAT M12 connector, 32 outputs, Negative common (PNP)
	<b>EX260-SEC2-X117</b>	EtherCAT M12 connector, 32 outputs, Positive common (NPN)
	<b>EX260-SEC3-X117</b>	EtherCAT M12 connector, 16 outputs, Negative common (PNP)
	<b>EX260-SEC4-X117</b>	EtherCAT M12 connector, 16 outputs, Positive common (NPN)
	<b>EX260-SMJ1-X117</b>	CC-Link M12 connector, 32 outputs, Negative common (PNP)
	<b>EX260-SMJ2-X117</b>	CC-Link M12 connector, 32 outputs, Positive common (NPN)
	<b>EX260-SMJ3-X117</b>	CC-Link M12 connector, 16 outputs, Negative common (PNP)
	<b>EX260-SMJ4-X117</b>	CC-Link M12 connector, 16 outputs, Positive common (NPN)
	<b>EX260-SPN1-X117</b>	PROFINET M12 connector, 32 outputs, Negative common (PNP)
	<b>EX260-SPN2-X117</b>	PROFINET M12 connector, 32 outputs, Positive common (NPN)
	<b>EX260-SPN3-X117</b>	PROFINET M12 connector, 16 outputs, Negative common (PNP)
	<b>EX260-SPN4-X117</b>	PROFINET M12 connector, 16 outputs, Positive common (NPN)
	<b>EX260-SEN1-X117</b>	EtherNet/IP™ M12 connector, 32 outputs, Negative common (PNP)
	<b>EX260-SEN2-X117</b>	EtherNet/IP™ M12 connector, 32 outputs, Positive common (NPN)
	<b>EX260-SEN3-X117</b>	EtherNet/IP™ M12 connector, 16 outputs, Negative common (PNP)
<b>EX260-SEN4-X117</b>	EtherNet/IP™ M12 connector, 16 outputs, Positive common (NPN)	
EX126 SI unit	<b>EX126-SMJ1-X220</b>	CC-Link (Terminal block, 16 outputs, Positive common (NPN))
	<b>EX120-SDN1-X220</b>	DeviceNet™ (Terminal block, 16 outputs, Positive common (NPN))

## Valve Mounting Screw Part No.

Description	Part no.	Note
	<b>25A-JJ5SY3</b>	
Round head combination screw	<b>25A-JSY31V-23-1A</b>	Part numbers shown on the left are for 10 valves. (20 pcs.)

## One-touch Fittings Part Nos.

		Port size	25A-JSY3000
A, B port	Metric size	Ø 6 One-touch fitting (Straight type)	<b>25A-KQSY30-C6</b>
		Ø 8 One-touch fitting (Straight type)	<b>25A-KQSY30-C8-X1336</b>
P, E port	Metric size	Ø 10 One-touch fitting (Straight type)	<b>25A-KQSY31-C10-X1336</b>

## How to Order Individual SUP/EXH Spacer Assembly

One-touch fitting  
Straight type

**25A – JSY 3 1M – 38 P – 1 A – C6**



Spacer type	
<b>38</b>	Individual SUP spacer
<b>39</b>	Individual EXH spacer

### Port size (Metric)

Symbol	P, E port
<b>C6</b>	Ø 6 One-touch fitting

Part numbers of mounting screw  
(2 pcs. of each)

**25A-JSY31V-23-2A**





Type 40  
Side Ported

Non Plug-in Metal Base

# 25A-JSY3000 Series

RoHS

Internal Pilot

## How to Order Manifolds

25A - JJ5SY 3 - 40 - 05 D - C6

Series compatible with secondary batteries

### 1 Series

3	JSY3000
---	---------

### 2 Type

40	Side ported
----	-------------

### 3 Valve stations

Symbol	Stations
02	2 stations
⋮	⋮
20	20 stations

### 4 P, E port entry

U	U side*1
D	D side*1
B	Both sides

\*1 Plugs are mounted on the opposite side of the selected ports.

### 5 A, B port size

#### Thread piping

Symbol	A, B port
M5	M5 x 0.8
01	1/8

### 6 Thread type

—	Rc
---	----

### One-touch fitting (Metric)

Symbol		A, B port	
Fixed	C6	∅ 6	
	KC6	∅ 6	
Replaceable	KC8	∅ 8	
	M*1	A, B ports mixed	
P, E port size (Thread piping)		1/4	

\*1 When ports are mixed sizes, indicate the piping specifications on the manifold specification sheet.

\* The 25A- series specifications and dimensions are the same as those of the standard model.

## How to Order Manifold Assembly

### Example (25A-JJ5SY3-40-□)

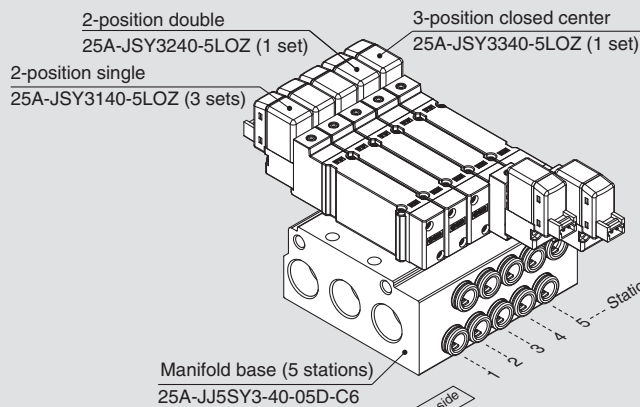

25A-JJ5SY3-40-05D-C6 ..1 set (Type 40 5-station manifold base part no.)

\* 25A-JSY3140-5LOZ ..... 3 sets (2-position single part no.)

\* 25A-JSY3240-5LOZ ..... 1 set (2-position double part no.)

\* 25A-JSY3340-5LOZ ..... 1 set (3-position closed centre part no.)

→ The asterisk denotes the symbol for the assembly. Prefix it to the part numbers of the valve, etc.

· The valve arrangement is numbered as the 1st station from the D side.  
· Under the manifold part number, state the valves to be mounted in order from the 1st station as shown in the figure. If the arrangement becomes complicated, specify on a manifold specification sheet.

Internal Pilot

How to Order Valves (With two mounting screws)

**25A-JSY3000 Series** **25A-JSY3** **1** **40-5** **L** **Z**

Series compatible with secondary batteries

① ② ③ ④ ⑤ ⑥ ⑦

**Made to Order**

**Made to Order**

Specification

With power saving circuit (Continuous duty type): 0.1 W

**① Series**

3	JSY3000
---	---------

**② Type of actuation**

1	2-position single
2	2-position double
3	3-position closed centre
4	3-position exhaust centre
5	3-position pressure centre
A	Dual 3-port (N.C./N.C.)
B	Dual 3-port (N.O./N.O.)
C	Dual 3-port (N.C./N.O.)

**③ Pilot valve exhaust method**

0	Pilot valve individual exhaust
---	--------------------------------

**④ Rated voltage**

5	24 VDC
---	--------

**⑥ Light/surge voltage suppressor**

Z	With light/surge voltage suppressor
---	-------------------------------------

**⑤ Electrical entry**

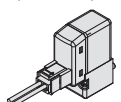
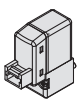
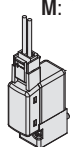
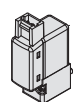
L plug connector		M plug connector	
L	LO	M	MO
L: With lead wire (300 mm)	LO: Without connector	M: With lead wire (300 mm)	MO: Without connector
			

\* Refer to the **Catalogue at [www.smc.eu](http://www.smc.eu)** for the lead wire length of L and M plug connectors.

**⑦ Manual override**

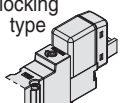
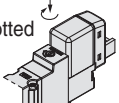
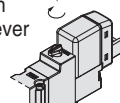
—: Non-locking push type	D: Push-turn locking slotted type	E: Push-turn locking lever type
		

\* The 25A- series specifications and dimensions are the same as those of the standard model.

**⚠ Caution**  
 If the valve will be continuously energised, please be sure to use the power saving circuit (continuous duty type). Refer to Made to Order.

# 25A-JSY3000 Series Manifold Options

## Blanking plate assembly

(With two mounting screws)

Used when valve additions are expected or for maintenance. A structure is in place on the blanking plate to prevent the mounting screws from sliding.

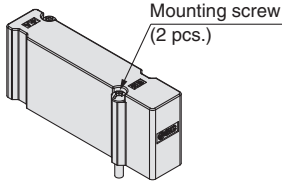

## How to Order Blanking Plate Assembly

**25A - JSY 3 1M - 26 - 1A**

Series

3	JSY3000
---	---------

## Valve Mounting Screw Part No.

Description	Part no.	Note
	Round head combination screw	

Part numbers shown on the left are for 10 valves. (20 pcs.)

## One-touch Fittings Part Nos.

		Port size	25A-JSY3000
A, B port	Metric size	Ø 6 One-touch fitting (Straight type)	25A-KQSY30-C6
		Ø 8 One-touch fitting (Straight type)	25A-KQSY30-C8-X1336

## How to Order Individual SUP/EXH Spacer Assembly

One-touch fitting  
Straight type

**25A - JSY 3 1M - 38 - 1 A - C6**

Series

3	JSY3000
---	---------

Spacer type

38	Individual SUP spacer
39	Individual EXH spacer

Port size (Metric)

Symbol	P, E port
C6	Ø 6 One-touch fitting

Part numbers of mounting screw  
(2 pcs. of each)  
25A-JSY31V-23-5A





Type 10  
Side Ported

Type 11  
Bottom Ported

# Plug-in Connector Connecting Base

D-sub Connector



# 25A-SY5000 Series



## How to Order Manifold

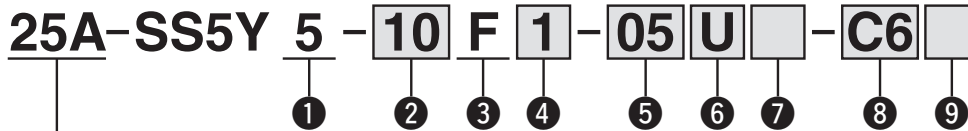

Series compatible with secondary batteries

### 1 Series

5	SY5000
---	--------

### 2 Type

10	Side ported
11	Bottom ported

### 3 Connector type

F: D-sub connector (25 pins)

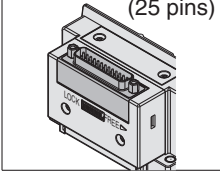

### 4 Connector entry direction

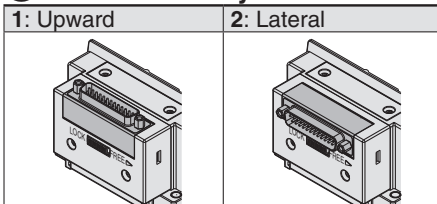

### 5 Valve stations

F: D-sub connector (25 pins)

Symbol	Stations	Note
02	2 stations	Double wiring*1
⋮	⋮	
12	12 stations	Specified layout*2 (Available up to 24 solenoids)
02	2 stations	
⋮	⋮	
24	24 stations	

\*1 Double wiring: 2-position single, double, 3-position, and 4-position valves can be used on all manifold stations. Use of a 2-position single solenoid will result in an unused control signal. If

this is not desired, order with a specified layout.

\*2 Specified layout: Indicate the wiring specifications on the manifold specification sheet. (Note that 2-position double, 3-position, and 4-position valves cannot be used where single wiring has been specified.)

\* This also includes the number of the blanking plate assembly.

### 6 P, E port entry

U	U side (2 to 10 stations)
D	D side (2 to 10 stations)
B	Both sides (2 to 24 stations)

### 7 SUP/EXH block assembly

—	Internal pilot
S	Internal pilot, Built-in silencer

\* 3/5(E) port is plugged for the built-in silencer type.

### 8 A, B port size (Metric)

Symbol	A, B port	Type 10/ Side ported	Type 11/ Bottom ported
		SY5000	SY5000
C4	Straight Ø 4 One-touch fitting	●	●
C6		●	●
C8		●	●
CM*1	Straight port, mixed sizes	●	●
P, E port size (One-touch fittings)		Ø 10	Ø 10

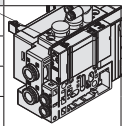

\*1 Indicate the sizes on the manifold specification sheet in the case of "CM."

\* The direction of P, E port fittings is the same as for the A, B port.

### 9 Mounting

Symbol	Mounting
—	Direct mounting
D□	DIN rail mounting

#### DIN rail option

Standard length	
0	With DIN bracket (Without DIN rail)
3	For 3 stations
⋮	⋮
24	For 24 stations

Specify a longer rail than the total length of specified stations.

\* Enter the number of stations inside □. (Refer to "DIN Rail Option" above.)

\* Only direct mounting is available for Type 11 (Bottom ported).

\* The 25A-series specifications and dimensions are the same as those of the standard model.

**How to Order Valves (With two mounting screws)**

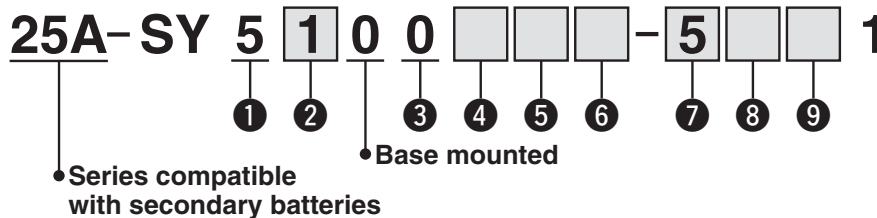

**1 Series**

5	SY5000
---	--------

**2 Type of actuation**

1	2-position single
2	2-position double
3	3-position closed centre
4	3-position exhaust centre
5	3-position pressure centre
A	4-position dual 3-port valve (N.C./N.C.)
B	4-position dual 3-port valve (N.O./N.O.)
C	4-position dual 3-port valve (N.C./N.O.)

**3 Seal type**

0	Rubber seal
---	-------------

**4 Back pressure check valve (Built-in valve type)**

—	None
H	Built-in

\* The built-in valve type back pressure check valve is not available for the 3-position type.

**5 Pilot valve option**

—	Standard (0.7 MPa)
B	Quick response type (0.7 MPa)

**6 Coil type**

—	Standard
T	With power saving circuit (Continuous duty type)

\* Be sure to select the power saving circuit type when the valve is continuously energised for long periods of time.  
 \* Be careful of the energising time when the power saving circuit is selected. For details, refer to the standard product catalogue.

**7 Rated voltage**

5	24 VDC
6	12 VDC

**8 Light/surge voltage suppressor and common specification**

—	Without light/surge voltage suppressor (Non-polar)
R	With surge voltage suppressor (Non-polar)
U	With light/surge voltage suppressor (Non-polar)
S	With surge voltage suppressor (Positive common)
Z	With light/surge voltage suppressor (Positive common)
NS	With surge voltage suppressor (Negative common)
NZ	With light/surge voltage suppressor (Negative common)

\* Only "Z" and "NZ" types are available for the product with power saving circuit.

**9 Manual override**

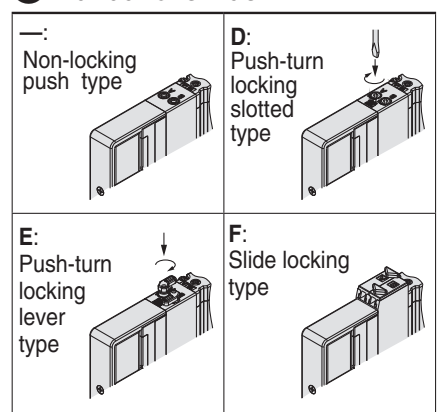

\* The 25A- series specifications and dimensions are the same as those of the standard model.

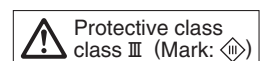

# Plug-in Connector Connecting Base

D-sub Connector



Type 12  
Top Ported

# 25A-SY5000 Series

## How to Order Manifold

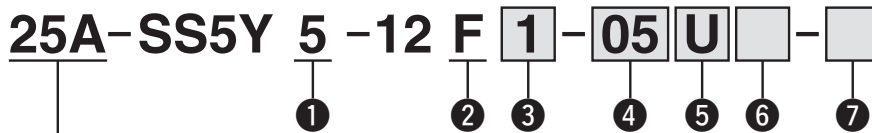

• Series compatible with secondary batteries

### 1 Series

5	SY5000
---	--------

### 2 Connector type

F: D-sub connector (25 pins)

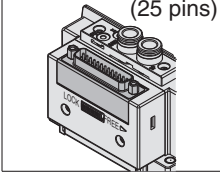

### 3 Connector entry direction

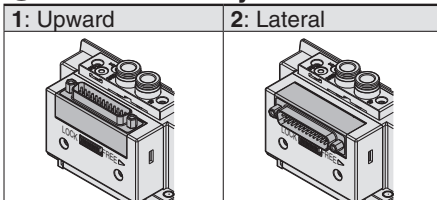

### 4 Valve stations

F: D-sub connector (25 pins)

Symbol	Stations	Note
02	2 stations	Double wiring*1
⋮	⋮	
12	12 stations	Specified layout*2 (Available up to 24 solenoids)
02	2 stations	
⋮	⋮	
24	24 stations	

\*1 Double wiring: 2-position single, double, 3-position, and 4-position valves can be used on all manifold stations. Use of a 2-position single solenoid will result in an unused control signal. If this is not desired, order

with a specified layout.

\*2 Specified layout: Indicate the wiring specifications on the manifold specification sheet. (Note that 2-position double, 3-position, and 4-position valves cannot be used where single wiring has been specified.)

\* This also includes the number of the blanking plate assembly.

### 5 P, E port entry

U*1	U side (2 to 10 stations)
D*1	D side (2 to 10 stations)
B	Both sides (2 to 24 stations)

\*1 For type "S," supply/exhaust block assembly with built-in silencer, choose "U" or "D" for P port entry.

### 6 SUP/EXH block assembly

—	Internal pilot
S	Internal pilot, Built-in silencer

\* For built-in silencer type, P and E ports are available on U and D sides. 3/5(E) port is plugged. The silencer exhaust port is located on the opposite side of P, E port entry. (Example: When the P, E port entry is D side, the silencer exhaust port is U side.)

### 7 Mounting

—	Direct mounting	
D	DIN rail mounting (With DIN rail)	
D0	DIN rail mounting (Without DIN rail)	
D3	For 3 stations	Specify a longer rail than the standard length.
⋮	⋮	
D24	For 24 stations	

\* The 25A- series specifications and dimensions are the same as those of the standard model.

How to Order Valves (With two mounting screws)

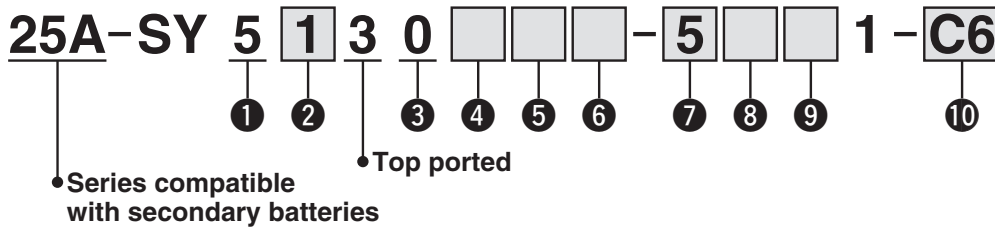

1 Series

5	SY5000
---	--------

2 Type of actuation

1	2-position single
2	2-position double
3	3-position closed centre
4	3-position exhaust centre
5	3-position pressure centre
A	4-position dual 3-port valve (N.C./N.C.)
B	4-position dual 3-port valve (N.O./N.O.)
C	4-position dual 3-port valve (N.C./N.O.)

3 Seal type

0	Rubber seal
---	-------------

4 Back pressure check valve (Built-in valve type)

—	None
H	Built-in

\* The built-in valve type back pressure check valve is not available for the 3-position type.

5 Pilot valve option

—	Standard (0.7 MPa)
B	Quick response type (0.7 MPa)

6 Coil type

—	Standard
T	With power saving circuit (Continuous duty type)

\* Be sure to select the power saving circuit type when the valve is continuously energised for long periods of time.  
 \* Be careful of the energising time when the power saving circuit is selected. For details, refer to the standard product catalogue.

7 Rated voltage

5	24 VDC
6	12 VDC

8 Light/surge voltage suppressor and common specification

—	Without light/surge voltage suppressor (Non-polar)
R	With surge voltage suppressor (Non-polar)
U	With light/surge voltage suppressor (Non-polar)
S	With surge voltage suppressor (Positive common)
Z	With light/surge voltage suppressor (Positive common)
NS	With surge voltage suppressor (Negative common)
NZ	With light/surge voltage suppressor (Negative common)

\* Only "Z" and "NZ" types are available for the product with power saving circuit.

9 Manual override

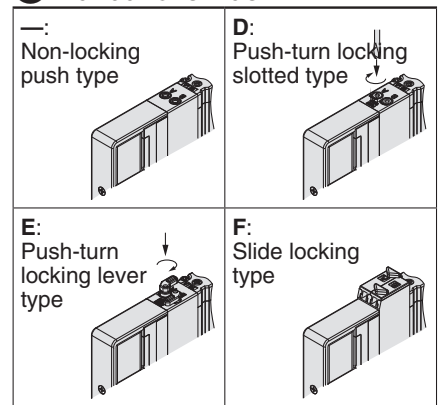

10 A, B port size

One-touch fitting (Metric)

Symbol	A, B port	SY5000
C4	∅ 4 One-touch fitting	●
C6	∅ 6 One-touch fitting	●
C8	∅ 8 One-touch fitting	●

\* The 25A- series specifications and dimensions are the same as those of the standard model.

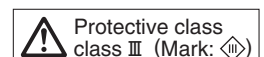



Type 10  
Side Ported

Type 11  
Bottom Ported

# Plug-in Connector Connecting Base

Terminal Block Box



# 25A-SY5000 Series



## How to Order Manifold

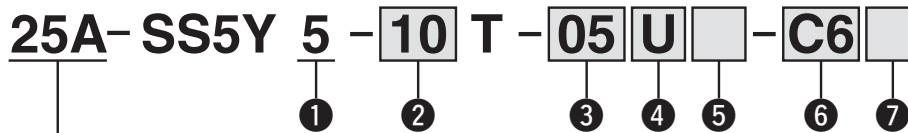

• Series compatible with secondary batteries

### 1 Series

5	SY5000
---	--------

### 2 Type

10	Side ported
11	Bottom ported

### 3 Valve stations

Symbol	Stations	Note
02	2 stations	Double wiring*1
⋮	⋮	
10	10 stations	Specified layout*2 (Available up to 20 solenoids)
02	2 stations	
⋮	⋮	
20	20 stations	

\*1 Double wiring: 2-position single, double, 3-position, and 4-position valves can be used on all manifold stations.

Use of a 2-position single solenoid will result in an unused control signal. If this is not desired, order with a specified layout.

\*2 Specified layout: Indicate the wiring specifications on the manifold specification sheet. (Note that 2-position double, 3-position, and 4-position valves cannot be used where single wiring has been specified.)

\* This also includes the number of the blanking plate assembly.

### 4 P, E port entry

U	U side (2 to 10 stations)
D	D side (2 to 10 stations)
B	Both sides (2 to 20 stations)

### 5 SUP/EXH block assembly

—	Internal pilot
S	Internal pilot, Built-in silencer

\* 3/5(E) port is plugged for the built-in silencer type.

\* When the built-in silencer type is used, keep the exhaust port from coming in direct contact with water or other liquids.

### 7 Mounting

Symbol	Mounting
—	Direct mounting
D□	DIN rail mounting

\* Enter the number of stations inside □. (Refer to "DIN Rail Option" below.)

\* Only direct mounting is available for Type 11 (Bottom ported).

### DIN rail option

—	Standard length
0	With DIN bracket (Without DIN rail)
3	For 3 stations
⋮	⋮
24	For 24 stations

Specify a longer rail than the total length of specified stations.

### 6 A, B port size (Metric)

Symbol	A, B port	Type 10/ Side ported	Type 11/ Bottom ported
		SY5000	SY5000
C4	Straight	●	●
C6		●	●
C8		●	●
CM*1	Straight port, mixed sizes	●	●
P, E port size (One-touch fittings)		Ø 10	Ø 10

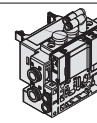

\*1 Indicate the sizes on the manifold specification sheet in the case of "CM."

\* The direction of P, E port fittings is the same as for the A, B port.

\* The 25A- series specifications and dimensions are the same as those of the standard model.

How to Order Valves (With two mounting screws)

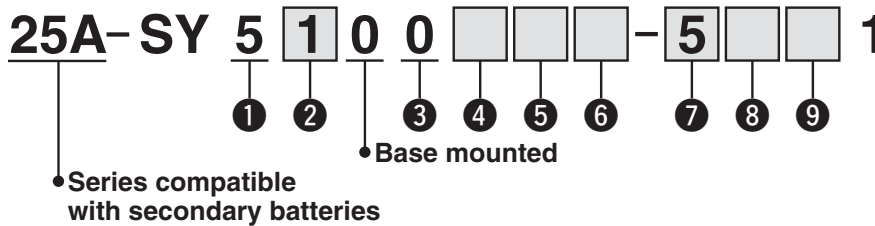

1 Series

5	SY5000
---	--------

2 Type of actuation

1	2-position single
2	2-position double
3	3-position closed centre
4	3-position exhaust centre
5	3-position pressure centre
A	4-position dual 3-port valve (N.C./N.C.)
B	4-position dual 3-port valve (N.O./N.O.)
C	4-position dual 3-port valve (N.C./N.O.)

3 Seal type

0	Rubber seal
---	-------------

4 Back pressure check valve (Built-in valve type)

—	None
H	Built-in

\* The built-in valve type back pressure check valve is not available for the 3-position type.

5 Pilot valve option

—	Standard (0.7 MPa)
B	Quick response type (0.7 MPa)

6 Coil type

—	Standard
T	With power saving circuit (Continuous duty type)

\* Be sure to select the power saving circuit type when the valve is continuously energised for long periods of time.  
\* Be careful of the energising time when the power saving circuit is selected. For details, refer to the standard product catalogue.

7 Rated voltage

5	24 VDC
6	12 VDC

8 Light/surge voltage suppressor and common specification

—	Without light/surge voltage suppressor (Non-polar)
R	With surge voltage suppressor (Non-polar)
U	With light/surge voltage suppressor (Non-polar)
S	With surge voltage suppressor (Positive common)
Z	With light/surge voltage suppressor (Positive common)
NS	With surge voltage suppressor (Negative common)
NZ	With light/surge voltage suppressor (Negative common)

\* Only "Z" and "NZ" types are available for the product with power saving circuit.

9 Manual override

—: Non-locking push type 	D: Push-turn locking slotted type 
E: Push-turn locking lever type 	F: Slide locking type 

\* The 25A- series specifications and dimensions are the same as those of the standard model.

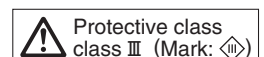

# Plug-in Connector Connecting Base

Terminal Block Box



# 25A-SY5000 Series



Type 12  
Top Ported

## How to Order Manifold

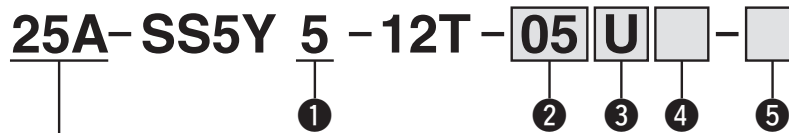

• Series compatible with secondary batteries

### 1 Series

5	SY5000
---	--------

### 3 P, E port entry

U*1	U side (2 to 10 stations)
D*1	D side (2 to 10 stations)
B	Both sides (2 to 20 stations)

\*1 4 For type "S," supply/exhaust block assembly with built-in silencer, choose "U" or "D" for P port entry.

### 2 Valve stations

Symbol	Stations	Note
02	2 stations	Double wiring*1
⋮	⋮	
10	10 stations	Specified layout*2 (Available up to 20 solenoids)
02	2 stations	
⋮	⋮	
20	20 stations	

\*1 Double wiring: 2-position single, double, 3-position, and 4-position valves can be used on all manifold stations. Use of a 2-position single solenoid will result in an unused control signal. If this is not desired, order with a specified layout.

\*2 Specified layout: Indicate the wiring specifications on the manifold specification sheet. (Note that 2-position double, 3-position, and 4-position valves cannot be used where single wiring has been specified.)

\* This also includes the number of the blanking plate assembly.

### 4 SUP/EXH block assembly

—	Internal pilot
S	Internal pilot, Built-in silencer

\* For built-in silencer type, P and E ports are available on U and D sides. 3/5(E) port is plugged. The silencer exhaust port is located on the opposite side of P, E port entry.

(Example: When the P, E port entry is D side, the silencer exhaust port is U side.)

\* When the built-in silencer type is used, keep the exhaust port from coming in direct contact with water or other liquids.

### 5 Mounting

—	Direct mounting	
D	DIN rail mounting (With DIN rail)	
D0	DIN rail mounting (Without DIN rail)	
D3	For 3 stations	Specify a longer rail than the standard length.
⋮	⋮	
D20	For 20 stations	

\* The 25A- series specifications and dimensions are the same as those of the standard model.

How to Order Valves (With two mounting screws)

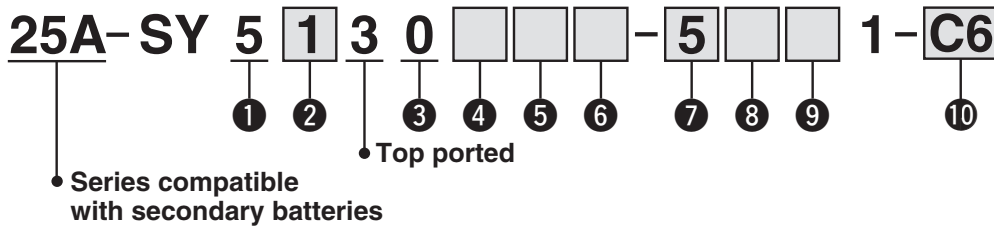

1 Series

5	SY5000
---	--------

2 Type of actuation

1	2-position single
2	2-position double
3	3-position closed centre
4	3-position exhaust centre
5	3-position pressure centre
A	4-position dual 3-port valve (N.C./N.C.)
B	4-position dual 3-port valve (N.O./N.O.)
C	4-position dual 3-port valve (N.C./N.O.)

3 Seal type

0	Rubber seal
---	-------------

4 Back pressure check valve (Built-in valve type)

—	None
H	Built-in

\* The built-in valve type back pressure check valve is not available for the 3-position type.

5 Pilot valve option

—	Standard (0.7 MPa)
B	Quick response type (0.7 MPa)

6 Coil type

—	Standard
T	With power saving circuit (Continuous duty type)

\* Be sure to select the power saving circuit type when the valve is continuously energised for long periods of time.  
\* Be careful of the energising time when the power saving circuit is selected. For details, refer to the standard product catalogue.

7 Rated voltage

5	24 VDC
6	12 VDC

8 Light/surge voltage suppressor and common specification

—	Without light/surge voltage suppressor (Non-polar)
R	With surge voltage suppressor (Non-polar)
U	With light/surge voltage suppressor (Non-polar)
S	With surge voltage suppressor (Positive common)
Z	With light/surge voltage suppressor (Positive common)
NS	With surge voltage suppressor (Negative common)
NZ	With light/surge voltage suppressor (Negative common)

\* Only "Z" and "NZ" types are available for the product with power saving circuit.

9 Manual override

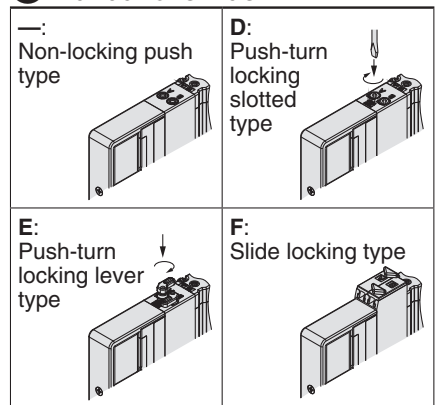

10 A, B port size One-touch fitting (Metric)

Symbol	A, B port	SY5000
C4	∅ 4 One-touch fitting	●
C6	∅ 6 One-touch fitting	●
C8	∅ 8 One-touch fitting	●

\* The 25A- series specifications and dimensions are the same as those of the standard model.

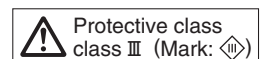



Type 10  
Side Ported

Type 11  
Bottom Ported

# Plug-in Connector Connecting Base

Lead Wire



# 25A-SY5000 Series



## How to Order Manifold

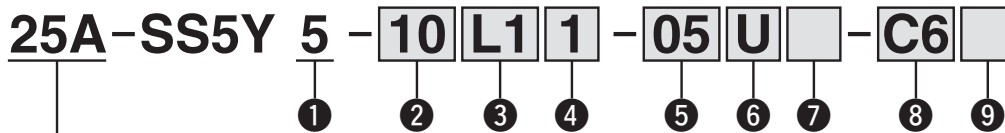

• Series compatible with secondary batteries

### 1 Series

5	SY5000
---	--------

### 3 Number of cores (Lead wire)

L1	34 cores
L2	17 cores
L3	9 cores

### 6 P, E port entry

U	U side (2 to 10 stations)
D	D side (2 to 10 stations)
B	Both sides (2 to 24 stations)

### 2 Type

10	Side ported
11	Bottom ported

### 4 Lead wire length

1	0.6 m
2	1.5 m
3	3 m

### 7 SUP/EXH block assembly

—	Internal pilot
S	Internal pilot, Built-in silencer

\* 3/5(E) port is plugged for the built-in silencer type.

\* When the built-in silencer type is used, keep the exhaust port from coming in direct contact with water or other liquids.

### 5 Valve stations

#### (L1□)

Symbol	Stations	Note
02	2 stations	Double wiring*1
⋮	⋮	
16	16 stations	Specified layout*2 (Available up to 32 solenoids)
02	2 stations	
⋮	⋮	
24	24 stations	

#### (L3□)

Symbol	Stations	Note
02	2 stations	Double wiring*1
⋮	⋮	
04	4 stations	Specified layout*2 (Available up to 8 solenoids)
02	2 stations	
⋮	⋮	
08	8 stations	

#### (L2□)

Symbol	Stations	Note
02	2 stations	Double wiring*1
⋮	⋮	
08	8 stations	Specified layout*2 (Available up to 16 solenoids)
02	2 stations	
⋮	⋮	
16	16 stations	

\*1 Double wiring: 2-position single, double, 3-position, and 4-position valves can be used on all manifold stations. Use of a 2-position single solenoid will result in an unused control signal. If this is not desired, order with a specified layout.

\*2 Specified layout: Indicate the wiring specifications on the manifold specification sheet. (Note that 2-position double, 3-position, and 4-position valves cannot be used where single wiring has been specified.)

\* This also includes the number of the blanking plate assembly.

### 8 A, B port size (Metric)

Symbol	A, B port	Type 10/ Side ported	Type 11/ Bottom ported
		SY5000	SY5000
C4	Straight Ø 4 One-touch fitting	●	●
C6		●	●
C8		●	●
CM*1	Straight port, mixed sizes	●	●
P, E port size (One-touch fittings)		Ø 10	Ø 10

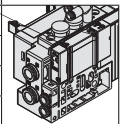

\*1 Indicate the sizes on the manifold specification sheet in the case of "CM."

\* The direction of P, E port fittings is the same as for the A, B port.

### 9 Mounting

Symbol	Mounting
—	Direct mounting
D□	DIN rail mounting

\* Enter the number of stations inside □. (Refer to "DIN Rail Option" below.)

\* Only direct mounting is available for Type 11 (Bottom ported).

#### DIN rail option

—	Standard length	
0	With DIN bracket (Without DIN rail)	
3	For 3 stations	Specify a longer rail than the total length of specified stations.
⋮	⋮	
24	For 24 stations	

\* The 25A- series specifications and dimensions are the same as those of the standard model.

**How to Order Valves (With two mounting screws)**

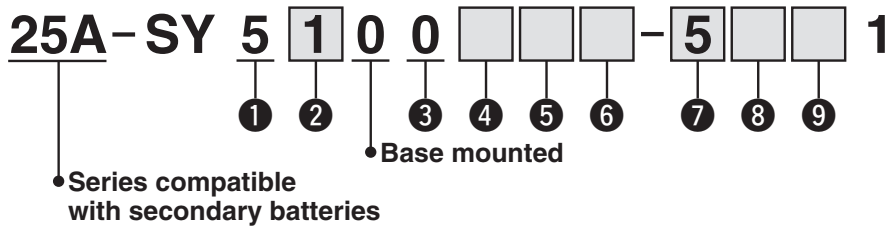

**1 Series**

5	SY5000
---	--------

**2 Type of actuation**

1	2-position single
2	2-position double
3	3-position closed centre
4	3-position exhaust centre
5	3-position pressure centre
A	4-position dual 3-port valve (N.C./N.C.)
B	4-position dual 3-port valve (N.O./N.O.)
C	4-position dual 3-port valve (N.C./N.O.)

**3 Seal type**

0	Rubber seal
---	-------------

**4 Back pressure check valve (Built-in valve type)**

—	None
H	Built-in

\* The built-in valve type back pressure check valve is not available for the 3-position type.

**5 Pilot valve option**

—	Standard (0.7 MPa)
B	Quick response type (0.7 MPa)

**6 Coil type**

—	Standard
T	With power saving circuit (Continuous duty type)

\* Be sure to select the power saving circuit type when the valve is continuously energised for long periods of time.  
 \* Be careful of the energising time when the power saving circuit is selected. For details, refer to the standard product catalogue.

**7 Rated voltage**

5	24 VDC
6	12 VDC

**8 Light/surge voltage suppressor and common specification**

—	Without light/surge voltage suppressor (Non-polar)
R	With surge voltage suppressor (Non-polar)
U	With light/surge voltage suppressor (Non-polar)
S	With surge voltage suppressor (Positive common)
Z	With light/surge voltage suppressor (Positive common)
NS	With surge voltage suppressor (Negative common)
NZ	With light/surge voltage suppressor (Negative common)

\* Only "Z" and "NZ" types are available for the product with power saving circuit.

**9 Manual override**

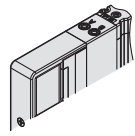
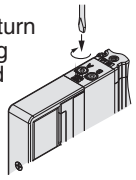
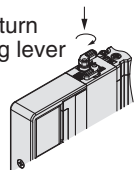
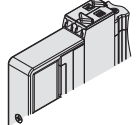
—: Non-locking push type 	D: Push-turn locking slotted type 
E: Push-turn locking lever type 	F: Slide locking type 

\* The 25A- series specifications and dimensions are the same as those of the standard model.

# Plug-in Connector Connecting Base

Lead Wire



Type 12  
Top Ported

# 25A-SY5000 Series

## How to Order Manifold

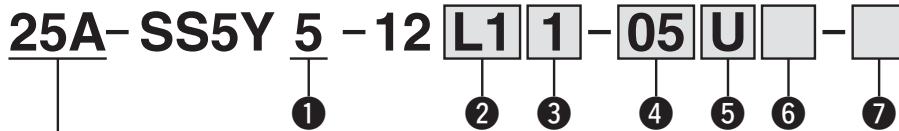

Series compatible with secondary batteries

### 1 Series

5	SY5000
---	--------

### 2 Number of cores (Lead wire)

L1	34 cores
L2	17 cores
L3	9 cores

### 3 Lead wire length

1	0.6 m
2	1.5 m
3	3 m

### 4 Valve stations

#### (L1□)

Symbol	Stations	Note
02	2 stations	Double wiring*1
⋮	⋮	
16	16 stations	Specified layout*2 (Available up to 32 solenoids)
02	2 stations	
⋮	⋮	
24	24 stations	

#### (L3□)

Symbol	Stations	Note
02	2 stations	Double wiring*1
⋮	⋮	
04	4 stations	Specified layout*2 (Available up to 8 solenoids)
02	2 stations	
⋮	⋮	
08	8 stations	

#### (L2□)

Symbol	Stations	Note
02	2 stations	Double wiring*1
⋮	⋮	
08	8 stations	Specified layout*2 (Available up to 16 solenoids)
02	2 stations	
⋮	⋮	
16	16 stations	

\*1 Double wiring: 2-position single, double, 3-position, and 4-position valves can be used on all manifold stations. Use of a 2-position single solenoid will result in an unused control signal. If this is not desired, order with a specified layout.

\*2 Specified layout: Indicate the wiring specifications on the manifold specification sheet. (Note that 2-position double, 3-position, and 4-position valves cannot be used where single wiring has been specified.)

\* This also includes the number of the blanking plate assembly.

### 5 P, E port entry

U*1	U side (2 to 10 stations)
D*1	D side (2 to 10 stations)
B	Both sides (2 to 24 stations)

\*1 For type "S," supply/exhaust block assembly with built-in silencer, choose "U" or "D" for P port entry.

### 6 SUP/EXH block assembly

—	Internal pilot
S	Internal pilot, Built-in silencer

\* For built-in silencer type, P and E ports are available on U and D sides. 3/5(E) port is plugged. The silencer exhaust port is located on the opposite side of P, E port entry. (Example: When the P, E port entry is D side, the silencer exhaust port is U side.)

\* When the built-in silencer type is used, keep the exhaust port from coming in direct contact with water or other liquids.

### 7 Mounting

—	Direct mounting	
D	DIN rail mounting (With DIN rail)	
D0	DIN rail mounting (Without DIN rail)	
D3	For 3 stations	Specify a longer rail than the standard length.
⋮	⋮	
D24	For 24 stations	

\* The 25A- series specifications and dimensions are the same as those of the standard model.

**How to Order Valves (With two mounting screws)**

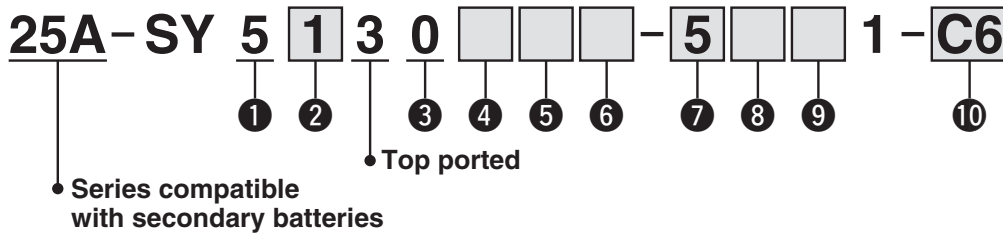

**1 Series**

5	SY5000
---	--------

**2 Type of actuation**

1	2-position single
2	2-position double
3	3-position closed centre
4	3-position exhaust centre
5	3-position pressure centre
A	4-position dual 3-port valve (N.C./N.C.)
B	4-position dual 3-port valve (N.O./N.O.)
C	4-position dual 3-port valve (N.C./N.O.)

**3 Seal type**

0	Rubber seal
---	-------------

**4 Back pressure check valve (Built-in valve type)**

—	None
H	Built-in

\* The built-in valve type back pressure check valve is not available for the 3-position type.

**5 Pilot valve option**

—	Standard (0.7 MPa)
B	Quick response type (0.7 MPa)

**6 Coil type**

—	Standard
T	With power saving circuit (Continuous duty type)

\* Be sure to select the power saving circuit type when the valve is continuously energised for long periods of time.  
\* Be careful of the energising time when the power saving circuit is selected. For details, refer to the standard product catalogue.

**7 Rated voltage**

5	24 VDC
6	12 VDC

**8 Light/surge voltage suppressor and common specification**

—	Without light/surge voltage suppressor (Non-polar)
R	With surge voltage suppressor (Non-polar)
U	With light/surge voltage suppressor (Non-polar)
S	With surge voltage suppressor (Positive common)
Z	With light/surge voltage suppressor (Positive common)
NS	With surge voltage suppressor (Negative common)
NZ	With light/surge voltage suppressor (Negative common)

\* Only "Z" and "NZ" types are available for the product with power saving circuit.

**9 Manual override**

—: Non-locking push type 	D: Push-turn locking slotted type 
E: Push-turn locking lever type 	F: Slide locking type 

**10 A, B port size One-touch fitting (Metric)**

Symbol	A, B port	SY5000
C4	∅ 4 One-touch fitting	●
C6	∅ 6 One-touch fitting	●
C8	∅ 8 One-touch fitting	●

\* The 25A- series specifications and dimensions are the same as those of the standard model.

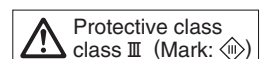



Type 10  
Side Ported

Type 11  
Bottom Ported

# Plug-in Connector Connecting Base

EX260



# 25A-SY5000 Series



## How to Order Manifold



Series compatible with secondary batteries

### 1 Series

5	SY5000
---	--------

### 2 Type

10	Side ported
11	Bottom ported

### 3 SI unit specifications

Symbol	Protocol	Number of outputs	Communication connector
0	Without SI unit		
QA	DeviceNet™	32	M12
QB		16	
NA	PROFIBUS	32	
NB		DP	
VA	CC-Link	32	
VB		16	
DA	EtherCAT	32	
DB		16	
FA	PROFINET	32	
FB		16	
EA	EtherNet/IP™	32	
EB		16	

For SI unit part number, refer to page 35. DIN rail cannot be mounted without SI unit.

### 4 SI unit output polarity

—	Positive common
N	Negative common

- \* Ensure a match with the common specifications of the value to be used.
- \* Without SI unit, the symbol is —.

### 8 A, B port size (Metric)

Symbol	A, B port	Type 10/ Side ported	Type 11/ Bottom ported
		SY5000	SY5000
C4	Straight Ø 4 One-touch fitting	●	●
C6		●	●
C8		●	●
CM*1		●	●
P, E port size (One-touch fittings)		Ø 10	Ø 10

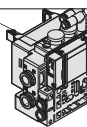

\*1 Indicate the sizes on the manifold specification sheet in the case of "CM."

### 5 Valve stations

In the case of the 32-output SI unit

Symbol	Stations	Note
02	2 stations	Double wiring*1
⋮	⋮	
16	16 stations	Specified layout*2 (Available up to 32 solenoids)
02	2 stations	
⋮	⋮	
24	24 stations	

In the case of the 16-output SI unit

Symbol	Stations	Note
02	2 stations	Double wiring*1
⋮	⋮	
08	8 stations	Specified layout*2 (Available up to 16 solenoids)
02	2 stations	
⋮	⋮	
16	16 stations	

- \*1 Double wiring: 2-position single, double, 3-position, and 4-position valves can be used on all manifold stations. Use of a 2-position single solenoid will result in an unused control signal. If this is not desired, order with a specified layout.
- \*2 Specified layout: Indicate the wiring specifications on the manifold specification sheet. (Note that 2-position double, 3-position, and 4-position valves cannot be used where single wiring has been specified.)
- \* This also includes the number of the blanking plate assembly.
- \* For the model without the SI unit (S0), note the maximum number of solenoids of the SI unit that will be mounted. If the layout is specified, indicate it on the manifold specification sheet.

### 6 P, E port entry

U	U side (2 to 10 stations)
D	D side (2 to 10 stations)
B	Both sides (2 to 24 stations)

### 7 SUP/EXH block assembly

—	Internal pilot
S	Internal pilot, Built-in silencer

- \* 3/5(E) port is plugged for the built-in silencer type.
- \* When the built-in silencer type is used, keep the exhaust port from coming in direct contact with water or other liquids.

### 9 Mounting

Symbol	Mounting
—	Direct mounting
D□	DIN rail mounting

- \* Enter the number of stations inside □. (Refer to "DIN Rail Option" below.)
- \* Only direct mounting is available for Type "11" (Bottom ported).

#### DIN rail option

—		Direct mounting
0	With DIN bracket (Without DIN rail)	
3	For 3 stations	Specify a longer rail than the total length of specified stations.
⋮	⋮	
24	For 24 stations	

- \* When it is necessary to mount a DIN rail without an SI unit, select "D0" and order DIN rail length separately, referring to L3 in the dimensions.

\* The 25A- series specifications and dimensions are the same as those of the standard model.

For details about the EX260 Integrated-type (For Output) Serial Transmission System, refer to the Catalogue at [www.smc.eu](http://www.smc.eu) and the Operation Manual. For details about part numbers of SI units to be mounted, refer to page 35 in this catalogue. Please download the Operation Manual via our website, <https://www.smc.eu>

**How to Order Valves (With two mounting screws)**

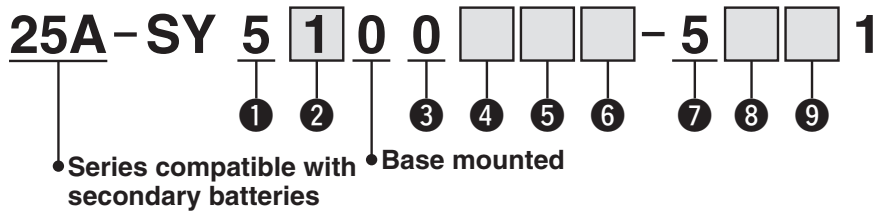

**① Series**

5	SY5000
---	--------

**② Type of actuation**

1	2-position single
2	2-position double
3	3-position closed centre
4	3-position exhaust centre
5	3-position pressure centre
A	4-position dual 3-port valve (N.C./N.C.)
B	4-position dual 3-port valve (N.O./N.O.)
C	4-position dual 3-port valve (N.C./N.O.)

**③ Seal type**

0	Rubber seal
---	-------------

**④ Back pressure check valve (Built-in valve type)**

—	None
H	Built-in

\* The built-in valve type back pressure check valve is not available for the 3-position type.

**⑤ Pilot valve option**

—	Standard (0.7 MPa)
B	Quick response type (0.7 MPa)

**⑥ Coil type**

—	Standard
T	With power saving circuit (Continuous duty type)

\* Be sure to select the power saving circuit type when the valve is continuously energised for long periods of time.  
 \* Be careful of the energising time when the power saving circuit is selected. For details, refer to the standard product catalogue.

**⑦ Rated voltage**

5	24 VDC
---	--------

**⑧ Light/surge voltage suppressor and common specification**

R	With surge voltage suppressor (Non-polar)
U	With light/surge voltage suppressor (Non-polar)
S	With surge voltage suppressor (Positive common)
Z	With light/surge voltage suppressor (Positive common)
NS	With surge voltage suppressor (Negative common)
NZ	With light/surge voltage suppressor (Negative common)

\* Select a valve from "R," "U," "S" or "Z" when the SI unit output polarity is — (Positive common). Select a valve from "R," "U," "NS" or "NZ" when the SI unit output polarity is "N" (Negative common).  
 \* Only "Z" and "NZ" types are available for the product with power saving circuit.

**⑨ Manual override**

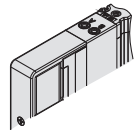
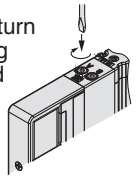
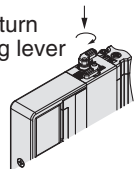
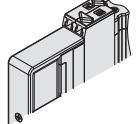
<p>—: Non-locking push type</p> 	<p>D: Push-turn locking slotted type</p> 
<p>E: Push-turn locking lever type</p> 	<p>F: Slide locking type</p> 

\* The 25A- series specifications and dimensions are the same as those of the standard model.

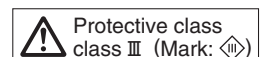

# Plug-in Connector Connecting Base

EX260



Type 12  
Top Ported

# 25A-SY5000 Series



## How to Order Manifold



• Series compatible with secondary batteries

### 1 Series

5	SY5000
---	--------

### 2 SI unit specifications

Symbol	Protocol	Number of outputs	Communication connector
0	Without SI unit		
QA	DeviceNet™	32	M12
QB		16	
NA	PROFIBUS	32	
NB		16	
VA	CC-Link	32	
VB		16	
DA	EtherCAT	32	
DB		16	
FA	PROFINET	32	
FB		16	
EA	EtherNet/IP™	32	
EB		16	

For SI unit part number, refer to page 35. DIN rail cannot be mounted without SI unit.

### 3 SI unit output polarity

—	Positive common (NPN)
N	Negative common (PNP)

- \* Ensure a match with the common specifications of the value to be used.
- \* Without SI unit, the symbol is —.

### 4 Valve stations

In the case of the 32-output SI unit

Symbol	Stations	Note
02	2 stations	Double wiring*1
⋮	⋮	
16	16 stations	Specified layout*2 (Available up to 32 solenoids)
02	2 stations	
⋮	⋮	
24	24 stations	

In the case of the 16-output SI unit

Symbol	Stations	Note
02	2 stations	Double wiring*1
⋮	⋮	
08	8 stations	Specified layout*2 (Available up to 16 solenoids)
02	2 stations	
⋮	⋮	
16	16 stations	

- \*1 Double wiring: 2-position single, double, 3-position, and 4-position valves can be used on all manifold stations. Use of a 2-position single solenoid will result in an unused control signal. If this is not desired, order with a specified layout.
- \*2 Specified layout: Indicate the wiring specifications on the manifold specification sheet. (Note that 2-position double, 3-position, and 4-position valves cannot be used where single wiring has been specified.)
- \* This also includes the number of the blanking plate assembly.
- \* For the model without the SI unit (S0), note the maximum number of solenoids of the SI unit that will be mounted. If the layout is specified, indicate it on the manifold specification sheet.

### 5 P, E port entry

U*1	U side (2 to 10 stations)
D*1	D side (2 to 10 stations)
B	Both sides (2 to 24 stations)

- \*1 For type “S,” supply/exhaust block assembly with built-in silencer, choose “U” or “D” for P port entry.

### 6 SUP/EXH block assembly

—	Internal pilot
S	Internal pilot, Built-in silencer

- \* For built-in silencer type, P and E ports are available on U and D sides. 3/5(E) port is plugged. The silencer exhaust port is located on the opposite side of P, E port entry. (Example: When the P, E port entry is D side, the silencer exhaust port is U side.)
- \* When the built-in silencer type is used, keep the exhaust port from coming in direct contact with water or other liquids.

### 7 Mounting

Direct mounting	
D	DIN rail mounting (With DIN rail)
D0	DIN rail mounting (Without DIN rail)
D3	For 3 stations
⋮	⋮
D24	For 24 stations

Specify a longer rail than the standard length.

- \* When it is necessary to mount a DIN rail without an SI unit, select “D0” and order DIN rail length separately, referring to L3 in the dimensions.

- \* The 25A- series specifications and dimensions are the same as those of the standard model.

For details about the EX260 Integrated-type (For Output) Serial Transmission System, refer to the Catalogue at [www.smc.eu](http://www.smc.eu) and the Operation Manual. For details about part numbers of SI units to be mounted, refer to page 35 in this catalogue. Please download the Operation Manual via our website, <https://www.smc.eu>

**How to Order Valves (With two mounting screws)**

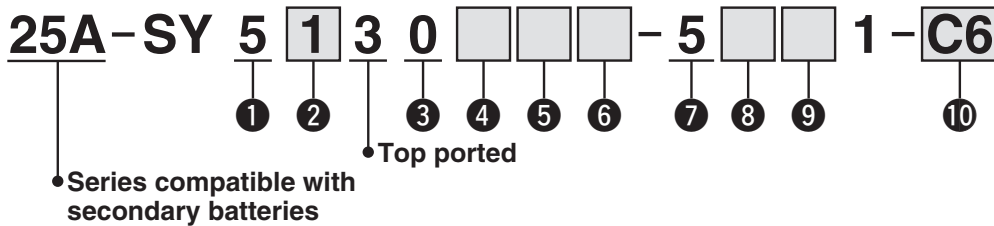

**1 Series**

5	SY5000
---	--------

**2 Type of actuation**

1	2-position single
2	2-position double
3	3-position closed centre
4	3-position exhaust centre
5	3-position pressure centre
A	4-position dual 3-port valve (N.C./N.C.)
B	4-position dual 3-port valve (N.O./N.O.)
C	4-position dual 3-port valve (N.C./N.O.)

**3 Seal type**

0	Rubber seal
---	-------------

**4 Back pressure check valve (Built-in valve type)**

—	None
H	Built-in

\* The built-in valve type back pressure check valve is not available for the 3-position type.

**5 Pilot valve option**

—	Standard (0.7 MPa)
B	Quick response type (0.7 MPa)

**6 Coil type**

—	Standard
T	With power saving circuit (Continuous duty type)

\* Be sure to select the power saving circuit type when the valve is continuously energised for long periods of time.  
 \* Be careful of the energising time when the power saving circuit is selected. For details, refer to the standard product catalogue.

**7 Rated voltage**

5	24 VDC
---	--------

**8 Light/surge voltage suppressor and common specification**

R	With surge voltage suppressor (Non-polar)
U	With light/surge voltage suppressor (Non-polar)
S	With surge voltage suppressor (Positive common)
Z	With light/surge voltage suppressor (Positive common)
NS	With surge voltage suppressor (Negative common)
NZ	With light/surge voltage suppressor (Negative common)

\* Select a valve from "R," "U," "S" or "Z" when the SI unit output polarity is — (Positive common). Select a valve from "R," "U," "NS" or "NZ" when the SI unit output polarity is "N" (Negative common).  
 \* Only "Z" and "NZ" types are available for the product with power saving circuit.

**9 Manual override**

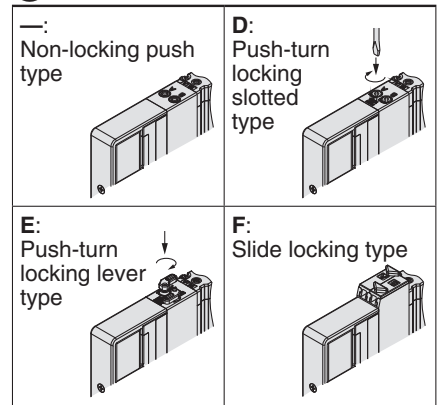

**10 A, B port size**

**One-touch fitting (Metric)**

Symbol	A, B port	SY5000
C4	Ø 4 One-touch fitting	●
C6	Ø 6 One-touch fitting	●
C8	Ø 8 One-touch fitting	●

\* The 25A- series specifications and dimensions are the same as those of the standard model.

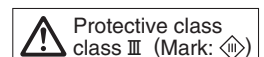

Type 10  
Side Ported

Type 11  
Bottom Ported

# Plug-in Connector Connecting Base

EX126



# 25A-SY5000 Series



## How to Order Manifold

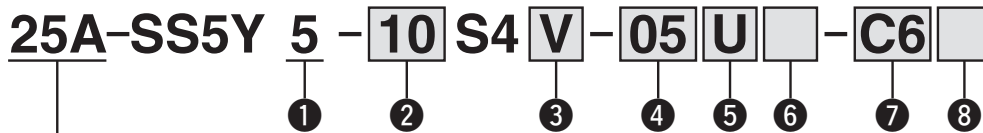

• Series compatible with secondary batteries

### 1 Series

5	SY5000
---	--------

### 2 Type

10	Side ported
11	Bottom ported

### 3 SI unit

0	Without SI unit
V	CC-Link (Positive common NPN)

\* Only a terminal block plate is mounted for the valve without SI unit.  
For SI unit part number, refer to page 35.

### 4 Valve stations

Symbol	Stations	Note
02	2 stations	Double wiring*1
⋮	⋮	
08	8 stations	
02	2 stations	Specified layout*2 (Available up to 16 solenoids)
⋮	⋮	
16	16 stations	

\*1 Double wiring: 2-position single, double, 3-position, and 4-position valves can be used on all manifold stations.  
Use of a 2-position single solenoid will result in an unused control signal. If this is not desired, order with a specified layout.

\*2 Specified layout: Indicate the wiring specifications on the manifold specification sheet. (Note that 2-position double, 3-position, and 4-position valves cannot be used where single wiring has been specified.)

\* This also includes the number of the blanking plate assembly.

### 5 P, E port entry

U	U side (2 to 10 stations)
D	D side (2 to 10 stations)
B	Both sides (2 to 16 stations)

### 6 SUP/EXH block assembly

—	Internal pilot
S	Internal pilot, Built-in silencer

\* 3/5(E) port is plugged for the built-in silencer type.  
\* When the built-in silencer type is used, keep the exhaust port from coming in direct contact with water or other liquids.

### 7 A, B port (Metric)

Symbol	A, B port	Type 10/ Side ported	Type 11/ Bottom ported	
		SY5000	SY5000	
C4	Straight ∅ 4 One-touch fitting	●	●	
C6		∅ 6 One-touch fitting	●	●
C8		∅ 8 One-touch fitting	●	●
CM*1	Straight port, mixed sizes	●	●	
P, E port size (One-touch fittings)		∅ 10	∅ 10	

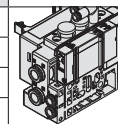

\*1 Indicate the size on the manifold specification sheet in the case of "CM."

\* The direction of P, E port fittings is the same as for the A, B port.

### 8 Mounting

Symbol	Mounting
—	Direct mounting
D□	DIN rail mounting

\* Enter the number of stations inside □.  
(Refer to "DIN Rail Option" below.)  
\* Only direct mounting is available for Type 11 (Bottom ported).

#### DIN rail option

—	Standard length
0	With DIN bracket (Without DIN rail)
3	For 3 stations
⋮	⋮
16	For 16 stations

Specify a longer rail than the total length of specified stations.

\* The 25A-series specifications and dimensions are the same as those of the standard model.

For details about the EX126 Integrated-type (For Output) Serial Transmission System, refer to the Catalogue at [www.smc.eu](http://www.smc.eu) and the Operation Manual. For details about part numbers of SI units to be mounted, refer to page 35 in this catalogue. Please download the Operation Manual via our website, <https://www.smc.eu>



**How to Order Valves (With two mounting screws)**

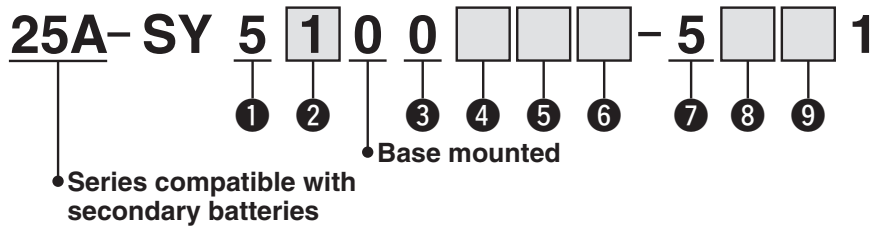

**1 Series**

5	SY5000
---	--------

**2 Type of actuation**

1	2-position single
2	2-position double
3	3-position closed centre
4	3-position exhaust centre
5	3-position pressure centre
A	4-position dual 3-port valve (N.C./N.C.)
B	4-position dual 3-port valve (N.O./N.O.)
C	4-position dual 3-port valve (N.C./N.O.)

**3 Seal type**

0	Rubber seal
---	-------------

**4 Back pressure check valve (Built-in valve type)**

—	None
H	Built-in

\* The built-in valve type back pressure check valve is not available for the 3-position type.

**5 Pilot valve option**

—	Standard (0.7 MPa)
B	Quick response type (0.7 MPa)

**6 Coil type**

—	Standard
T	With power saving circuit (Continuous duty type)

\* Be sure to select the power saving circuit type when the valve is continuously energised for long periods of time.  
 \* Be careful of the energising time when the power saving circuit is selected. For details, refer to the standard product catalogue.

**7 Rated voltage**

5	24 VDC
---	--------

**8 Light/surge voltage suppressor and common specification**

R	With surge voltage suppressor (Non-polar)
U	With light/surge voltage suppressor (Non-polar)
S	With surge voltage suppressor (Positive common)
Z	With light/surge voltage suppressor (Positive common)

\* Only "Z" type is available for the product with power saving circuit.

**9 Manual override**

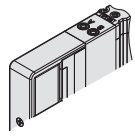
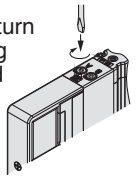
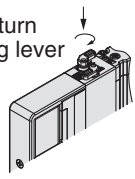
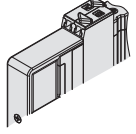
<p>—: Non-locking push type</p> 	<p>D: Push-turn locking slotted type</p> 
<p>E: Push-turn locking lever type</p> 	<p>F: Slide locking type</p> 

\* The 25A- series specifications and dimensions are the same as those of the standard model.

# Plug-in Connector Connecting Base

EX126



Type 12  
Top Ported

# 25A-SY5000 Series

## How to Order Manifold

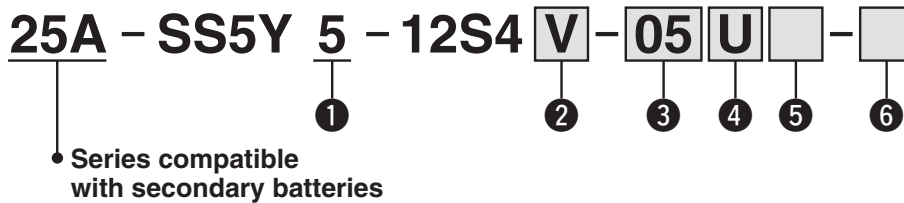

### 1 Series

5	SY5000
---	--------

### 2 SI unit

0	Without SI unit
V	CC-Link (Positive common NPN)

\* Only a terminal block plate is mounted for the valve without SI unit. For SI unit part number, refer to page 35.

### 3 Valve stations

Symbol	Stations	Note
02	2 stations	Double wiring*1
:	:	
08	8 stations	Specified layout*2 (Available up to 16 solenoids)
02	2 stations	
:	:	
16	16 stations	

- \*1 Double wiring: 2-position single, double, 3-position, and 4-position valves can be used on all manifold stations. Use of a 2-position single solenoid will result in an unused control signal. If this is not desired, order with a specified layout.
- \*2 Specified layout: Indicate the wiring specifications on the manifold specification sheet. (Note that 2-position double, 3-position, and 4-position valves cannot be used where single wiring has been specified.)
- \* This also includes the number of the blanking plate assembly.

### 4 P, E port entry

U*1	U side (2 to 10 stations)
D*1	D side (2 to 10 stations)
B	Both sides (2 to 16 stations)

\*1 For type "S," supply/exhaust block assembly with built-in silencer, choose "U" or "D" for P port entry.

### 5 SUP/EXH block assembly

-	Internal pilot
S	Internal pilot, Built-in silencer

- \* For built-in silencer type, P and E ports are available on U and D sides. 3/5(E) port is plugged. The silencer exhaust port is located on the opposite side of P, E port entry. (Example: When the P, E port entry is D side, the silencer exhaust port is U side.)
- \* When the built-in silencer type is used, keep the exhaust port from coming in direct contact with water or other liquids.

### 6 Mounting

	Direct mounting	
D	DIN rail mounting (With DIN rail)	
D0	DIN rail mounting (Without DIN rail)	
D3	For 3 stations	Specify a longer rail than the standard length.
:	:	
D16	For 16 stations	

\* The 25A-series specifications and dimensions are the same as those of the standard model.

For details about the EX126 Integrated-type (For Output) Serial Transmission System, refer to the Catalogue at [www.smc.eu](http://www.smc.eu) and the Operation Manual. For details about part numbers of SI units to be mounted, refer to page 35 in this catalogue. Please download the Operation Manual via our website, <https://www.smc.eu>

### How to Order Valves (With two mounting screws)

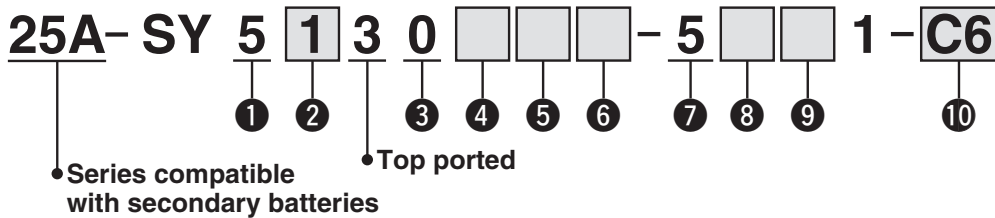

#### 1 Series

5	SY5000
---	--------

#### 2 Type of actuation

1	2-position single
2	2-position double
3	3-position closed centre
4	3-position exhaust centre
5	3-position pressure centre
A	4-position dual 3-port valve (N.C./N.C.)
B	4-position dual 3-port valve (N.O./N.O.)
C	4-position dual 3-port valve (N.C./N.O.)

#### 3 Seal type

0	Rubber seal
---	-------------

#### 4 Back pressure check valve (Built-in valve type)

—	None
H	Built-in

\* The built-in valve type back pressure check valve is not available for the 3-position type.

#### 5 Pilot valve option

—	Standard (0.7 MPa)
B	Quick response type (0.7 MPa)

#### 6 Coil type

—	Standard
T	With power saving circuit (Continuous duty type)

\* Be sure to select the power saving circuit type when the valve is continuously energised for long periods of time.  
 \* Be careful of the energising time when the power saving circuit is selected. For details, refer to the standard product catalogue.

#### 7 Rated voltage

5	24 VDC
---	--------

#### 8 Light/surge voltage suppressor and common specification

R	With surge voltage suppressor (Non-polar)
U	With light/surge voltage suppressor (Non-polar)
S	With surge voltage suppressor (Positive common)
Z	With light/surge voltage suppressor (Positive common)

\* Only "Z" type is available for models with a power saving circuit.

#### 9 Manual override

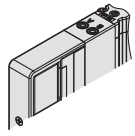
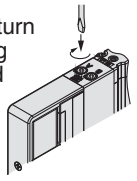
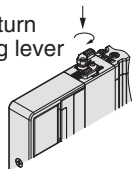
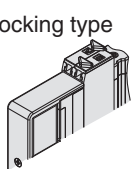
—: Non-locking push type 	D: Push-turn locking slotted type 
E: Push-turn locking lever type 	F: Slide locking type 

#### 10 A, B port size

##### One-touch fitting (Metric)

Symbol	A, B port	SY5000
C4	∅ 4 One-touch fitting	●
C6	∅ 6 One-touch fitting	●
C8	∅ 8 One-touch fitting	●

\* The 25A- series specifications and dimensions are the same as those of the standard model.

#### ⚠ Caution

Tightening torque for mounting screw M3: 0.8 N·m
---

### Manifold Options

#### ■ Blanking plate assembly

(With two mounting screws)  
 Used when valve additions are expected or for maintenance. A structure is in place on the blanking plate to prevent the mounting screws from sliding.

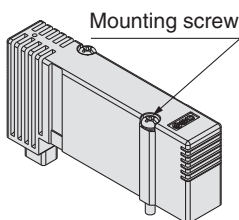

25A-SY50M-26-1A

#### How to Order Blanking Plate Assembly

**25A-SY 5 0M-26-1 A**

5	SY5000
---	--------

#### • Base type

1	For plug-in connector connecting base
---	---------------------------------------

\* The 25A- series specifications and dimensions are the same as those of the standard model.

# 25A-SY5000 Series

## SI Unit Part Nos.

Description	SI unit part no.	Note
EX260 SI unit	<b>EX260-SPR1-X117</b>	PROFIBUS DP M12 connector, 32 outputs, Negative common (PNP)
	<b>EX260-SPR2-X117</b>	PROFIBUS DP M12 connector, 32 outputs, Positive common (NPN)
	<b>EX260-SPR3-X117</b>	PROFIBUS DP M12 connector, 16 outputs, Negative common (PNP)
	<b>EX260-SPR4-X117</b>	PROFIBUS DP M12 connector, 16 outputs, Positive common (NPN)
	<b>EX260-SDN1-X117</b>	DeviceNet™ M12 connector, 32 outputs, Negative common (PNP)
	<b>EX260-SDN2-X117</b>	DeviceNet™ M12 connector, 32 outputs, Positive common (NPN)
	<b>EX260-SDN3-X117</b>	DeviceNet™ M12 connector, 16 outputs, Negative common (PNP)
	<b>EX260-SDN4-X117</b>	DeviceNet™ M12 connector, 16 outputs, Positive common (NPN)
	<b>EX260-SEC1-X117</b>	EtherCAT M12 connector, 32 outputs, Negative common (PNP)
	<b>EX260-SEC2-X117</b>	EtherCAT M12 connector, 32 outputs, Positive common (NPN)
	<b>EX260-SEC3-X117</b>	EtherCAT M12 connector, 16 outputs, Negative common (PNP)
	<b>EX260-SEC4-X117</b>	EtherCAT M12 connector, 16 outputs, Positive common (NPN)
	<b>EX260-SMJ1-X117</b>	CC-Link M12 connector, 32 outputs, Negative common (PNP)
	<b>EX260-SMJ2-X117</b>	CC-Link M12 connector, 32 outputs, Positive common (NPN)
	<b>EX260-SMJ3-X117</b>	CC-Link M12 connector, 16 outputs, Negative common (PNP)
	<b>EX260-SMJ4-X117</b>	CC-Link M12 connector, 16 outputs, Positive common (NPN)
	<b>EX260-SPN1-X117</b>	PROFINET M12 connector, 32 outputs, Negative common (PNP)
	<b>EX260-SPN2-X117</b>	PROFINET M12 connector, 32 outputs, Positive common (NPN)
	<b>EX260-SPN3-X117</b>	PROFINET M12 connector, 16 outputs, Negative common (PNP)
	<b>EX260-SPN4-X117</b>	PROFINET M12 connector, 16 outputs, Positive common (NPN)
EX126 SI unit	<b>EX260-SEN1-X117</b>	EtherNet/IP™ M12 connector, 32 outputs, Negative common (PNP)
	<b>EX260-SEN2-X117</b>	EtherNet/IP™ M12 connector, 32 outputs, Positive common (NPN)
	<b>EX260-SEN3-X117</b>	EtherNet/IP™ M12 connector, 16 outputs, Negative common (PNP)
	<b>EX260-SEN4-X117</b>	EtherNet/IP™ M12 connector, 16 outputs, Positive common (NPN)
EX126 SI unit	<b>EX126D-SMJ1-X220</b>	CC-Link (Terminal block, 16 outputs, Positive common (NPN))

## Valve Mounting Screw Part No.

Description	Part no.	Note
	<b>25A-SS5Y5</b>	
Round head combination screw	<b>SY5000-223-1A</b>	Part numbers shown on the left are for 10 valves. (20 pcs.)

## One-touch Fittings Part Nos.

Port size			25A-SY5000
A, B port	Metric size	Ø 4 One-touch fitting (Straight type)	<b>90-VVQ1000-51A-C4</b>
		Ø 6 One-touch fitting (Straight type)	<b>90-VVQ1000-51A-C6</b>
		Ø 8 One-touch fitting (Straight type)	<b>90-VVQ1000-51A-C8</b>
P, E port	Metric size	Ø 10 One-touch fitting (Straight type)	<b>90-VVQ2000-51A-C10</b>

## Manifold Options

### How to Order Individual SUP/EXH Spacer Assembly

One-touch fitting Straight type **25A-SY50M-38-1A-C6**

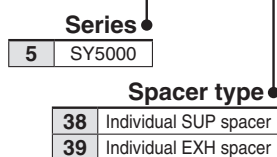

#### Port size (Metric)

Symbol	P, E port
<b>C4</b>	Ø 4 One-touch fitting
<b>C6</b>	Ø 6 One-touch fitting
<b>C8</b>	Ø 8 One-touch fitting

Part numbers of mounting screw (2 pcs. of each)  
SY5000: SY5000-223-2A

### How to Order Individual SUP/EXH Block Assembly

One-touch fitting Straight type **25A-SY50M-78-1A-C6**

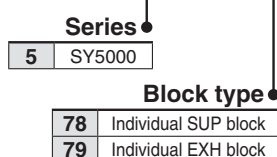

#### Port size (Metric)

Symbol	P, E port
<b>C4</b>	Ø 4 One-touch fitting
<b>C6</b>	Ø 6 One-touch fitting
<b>C8</b>	Ø 8 One-touch fitting

# 5-Port Solenoid Valve Body Ported/Single Unit



# 25A-SY5000/7000 Series

## How to Order

**25A - SY 5 1 20** [ ] - **5 L** [ ] [ ] - **01** [ ] - [ ] - [ ]

**Series compatible with secondary batteries**

**Series**

5	SY5000
7	SY7000

**Type of actuation**

1	2-position single
2	2-position double
3	3-position closed centre
4	3-position exhaust centre
5	3-position pressure centre

**Coil specifications**

—	Standard
T	With power saving circuit (24, 12 VDC only)

\* Power saving circuit is not available in the case of "D" or "Y" type.

**For DC**

5	24 VDC
6	12 VDC
V	6 VDC
S	5 VDC
R	3 VDC

**Rated voltage**

**For AC (50/60 Hz)**

1	100 VAC
2	200 VAC
3	110 VAC [115 VAC]
4	220 VAC [230 VAC]

\* DC specifications of type "D" and "Y" are only available with 12 and 24 VDC.  
\* AC-type models that are CE-compliant have DIN terminals only.

**CE-compliant**

—	—
Q	CE-compliant

\* AC-type models that are CE-compliant have DIN terminals only.

**Bracket**

—	Without bracket
F1	With foot bracket (2-position single only)
F2	With side bracket

**Thread type**

—	Rc
F	G

**A, B port size Thread piping**

Symbol	Port size	Applicable series
01	1/8	SY5000
02	1/4	SY7000

**One-touch fitting (Metric size)**

Symbol	Port size	Applicable series
C4	One-touch fitting for Ø 4	SY5000
C6	One-touch fitting for Ø 6	
C8	One-touch fitting for Ø 8	
C8	One-touch fitting for Ø 8	SY7000
C10	One-touch fitting for Ø 10	

**Manual override**

—: Non-locking push type    D: Push-turn locking slotted type    E: Push-turn locking lever type

**Light/surge voltage suppressor**

**Electrical entry for G, H, L, M**

—	Without light/surge voltage suppressor
S	With surge voltage suppressor
Z	With light/surge voltage suppressor
R	With surge voltage suppressor (Non-polar type)
U	With light/surge voltage suppressor (Non-polar type)

**Electrical entry for D, Y**

—	Without light/surge voltage suppressor
S	With surge voltage suppressor
Z	With light/surge voltage suppressor

\* There is no "S" type for AC mode, since a rectifier prevents surge voltage generation.  
\* For "R" and "U," DC voltage is only available.  
\* Power saving circuit is only available in the "Z" type.

**Electrical entry**

24, 12, 6, 5, 3 VDC/100, 110, 200, 220 VAC				24, 12 VDC/100, 110, 200, 220 VAC
Grommet	L plug connector	M plug connector	DIN terminal	D, Y: With connector
G: With lead wire (Length 300 mm)	L: With lead wire (Length 300 mm)	M: With lead wire (Length 300 mm)	MN: Without lead wire	D, Y: With connector
H: With lead wire (Length 600 mm)	LN: Without lead wire	LO: Without connector	MO: Without connector	

\* "LN," "MN" type: with 2 sockets.  
\* "Y" type is a DIN terminal conforming to EN-175301-803C (former DIN43650C).  
\* Refer to the standard products for the lead wire length of L and M plug connectors and the connector assembly with cover for L and M plug connector.

\* When placing an order for body ported solenoid valve as a single unit, mounting screw for manifold and gasket are not attached. Order them separately, if necessary.

\* The 25A- series specifications and dimensions are the same as those of the standard model.



# 5-Port Solenoid Valve Base Mounted/Single Unit

# 25A-SY5000/7000 Series



## How to Order

**25A - SY 5 2 40 [ ] [ ] - 5 L [ ] [ ] - [ ] [ ] - [ ]**

**Series compatible with secondary batteries**

**Series**

5	SY5000
7	SY7000

**Type of actuation**

1	2-position single
2	2-position double
3	3-position closed centre
4	3-position exhaust centre
5	3-position pressure centre

**Pilot type**

—	Internal pilot
R	External pilot

**Coil specifications**

—	Standard
T	With power saving circuit (24, 12 VDC only)

\* Power saving circuit is not available in the case of "D" or "Y" type.

**Rated voltage**

**For DC**

5	24 VDC
6	12 VDC
V	6 VDC
S	5 VDC
R	3 VDC

**For AC (50/60Hz)**

1	100 VAC
2	200 VAC
3	110 VAC [115 VAC]
4	220 VAC [230 VAC]

\* DC specifications of type "D" and "Y" are only available with 12 and 24 VDC.  
\* AC-type models that are CE-compliant have DIN terminals only.

**CE-compliant**

—	—
Q	CE-compliant

\* AC-type models that are CE-compliant have DIN terminals only.

**Thread type**

—	Rc
F	G

**Port size**

Symbol	Port size	Applicable series
—	Without sub-plate	
02	1/4 With sub-plate	SY5000 SY7000
03	3/8 With sub-plate	SY7000

**Manual override**

—: Non-locking push type	D: Push-turn locking slotted type	E: Push locking lever type
--------------------------	-----------------------------------	----------------------------

**Light/surge voltage suppressor**

**Electrical entry for G, H, L, M**

—	Without light/surge voltage suppressor
S	With surge voltage suppressor
Z	With light/surge voltage suppressor
R	With surge voltage suppressor (Non-polar type)
U	With light/surge voltage suppressor (Non-polar type)

\* There is no "S" type for AC mode, since a rectifier prevents surge voltage generation.  
\* For "R" and "U," DC voltage is only available.  
\* Power saving circuit is only available in the "Z" type.

**Electrical entry for D, Y**

—	Without light/surge voltage suppressor
S	With surge voltage suppressor (Non-polar type)
Z	With light/surge voltage suppressor (Non-polar type)

\* There is no "S" type for AC mode, since a rectifier prevents surge voltage generation.

**Electrical entry**

24, 12, 6, 5, 3 VDC / 100, 110, 200, 220 VAC				24, 12 VDC / 100, 110, 200, 220 VAC
Grommet	L plug connector	M plug connector	MN: Without lead wire	D, Y: With connector
G: With lead wire (Length 300 mm)	L: With lead wire (Length 300 mm)	M: With lead wire (Length 300 mm)	MN: Without lead wire	D, Y: With connector
H: With lead wire (Length 600 mm)	LN: Without lead wire	LO: Without connector	MO: Without connector	

\* "LN," "MN" type: with 2 sockets.  
\* "Y" type is a DIN terminal conforming to EN-175301-803C (former DIN43650C).  
\* Refer to the standard products for the lead wire length of L and M plug connectors and the connector assembly with cover for L and M plug connector.

\* The 25A- series specifications and dimensions are the same as those of the standard model.

# 5-Port Solenoid Valve Body Ported Manifold Bar Stock Type/Individual Wiring



Type **20**

# 25A-SY5000/7000 Series

## How to Order Manifold

25A - SS5Y **5** - 20 - **05** -  -

• Series compatible with secondary batteries

• Manifold series

5	SY5000
7	SY7000

• CE-compliant

—	—
Q	CE-compliant

\* AC-type models that are CE-compliant have DIN terminals only.

• Thread type

—	Rc
00F	G

• Stations

02	2 stations
⋮	⋮
20	20 stations

\* This also includes the number of the blanking plate assembly.

\* The 25A- series specifications and dimensions are the same as those of the standard model. However, the blanking plate assembly has different dimensions. Refer to page 42.



## How to Order Valves

25A – SY 5 1 20 [ ] – 5 L [ ] [ ] – 01 [ ] – [ ]

• Series compatible with secondary batteries

Series	
5	SY5000
7	SY7000

• Type of actuation

1	2-position single
2	2-position double
3	3-position closed centre
4	3-position exhaust centre
5	3-position pressure centre

• Coil specifications

—	Standard
T	With power saving circuit (24 VDC, 12 VDC only)

\* Power saving circuit is not available in the case of “D” or “Y” type.

• Rated voltage

For DC		For AC (50/60Hz)	
5	24 VDC	1	100 VAC
6	12 VDC	2	200 VAC
V	6 VDC	3	110 VAC [115 VAC]
S	5 VDC	4	220 VAC [230 VAC]
R	3 VDC		

\* DC specifications of type “D” and “Y” are only available with 12 and 24 VDC.  
\* AC-type models that are CE-compliant have DIN terminals only.

• CE-compliant

—	—
Q	CE-compliant

\* AC-type models that are CE-compliant have DIN terminals only.

• Thread type

—	Rc
F	G

• A, B port size  
Thread piping

Symbol	Port size	Applicable series
01	1/8	SY5000
02	1/4	SY7000

• One-touch fitting (Metric size)

Symbol	Port size	Applicable series
C4	One-touch fitting for Ø 4	SY5000
C6	One-touch fitting for Ø 6	
C8	One-touch fitting for Ø 8	
C8	One-touch fitting for Ø 8	SY7000
C10	One-touch fitting for Ø 10	

• Manual override

—	Non-locking push type
D	Push-turn locking slotted type
E	Push-turn locking lever type

• Light/surge voltage suppressor

Electrical entry for G, H, L, M

—	Without light/surge voltage suppressor
S	With surge voltage suppressor
Z	With light/surge voltage suppressor
R	With surge voltage suppressor (Non-polar type)
U	With light/surge voltage suppressor (Non-polar type)

\* There is no “S” type for AC mode, since a rectifier prevents surge voltage generation.  
\* For “R” and “U,” DC voltage is only available.  
\* Power saving circuit is only available in the “Z” type.

Electrical entry for D, Y

—	Without light/surge voltage suppressor
S	With surge voltage suppressor (Non-polar type)
Z	With light/surge voltage suppressor (Non-polar type)

\* There is no “S” type for AC mode, since a rectifier prevents surge voltage generation.

• Electrical entry

24, 12, 6, 5, 3 VDC/100, 110, 200, 220 VAC			24, 12 VDC/ 100, 110, 200, 220 VAC
Grommet	L plug connector	M plug connector	DIN terminal
<b>G:</b> With lead wire (Length 300 mm) <b>H:</b> With lead wire (Length 600 mm)	<b>L:</b> With lead wire (Length 300 mm) <b>LN:</b> Without lead wire <b>LO:</b> Without connector	<b>M:</b> With lead wire (Length 300 mm) <b>MN:</b> Without lead wire <b>MO:</b> Without connector	<b>D:</b> With connector <b>Y:</b> With connector

\* “LN,” “MN” type: with 2 sockets.  
\* “Y” type is a DIN terminal conforming to EN-175301-803C (former DIN43650C).  
\* Refer to the standard products for the lead wire length of L and M plug connectors and the connector assembly with cover for L and M plug connector.

\* The 25A- series specifications and dimensions are the same as those of the standard model.

Type **41**

Type **42**

# 5-Port Solenoid Valve Base Mounted Manifold Bar Stock Type/Individual Wiring



# 25A-SY5000/7000 Series

## How to Order Manifold

### Type 41/Compact type

**25A – SS5Y 5 – 41 – 05 – C8** [ ] – [ ]

• Series compatible with secondary batteries

Manifold series

5	SY5000
---	--------

Stations

02	2 stations
⋮	⋮
20	20 stations

\* This also includes the number of the blanking plate assembly.

• Thread type

—	Rc
F	G

• A, B port size  
Thread piping

Symbol	Port size	Applicable series
01	1/8	SY5000

One-touch fitting (Metric size)

Symbol	Port size	Applicable series
C6	One-touch fitting for Ø 6	SY5000
C8	One-touch fitting for Ø 8	

One-touch fitting (Inch size)

Symbol	Port size	Applicable series
N7	One-touch fitting for Ø 1/4"	SY5000
N9	One-touch fitting for Ø 5/16"	

• CE-compliant

—	—
Q	CE-compliant

\* AC-type models that are CE-compliant have DIN terminals only.

### Type 42/External pilot capable

**25A – SS5Y 5 – 42 – 05 – C8** [ ] – [ ]

• Series compatible with secondary batteries

Manifold series

5	SY5000
7	SY7000

Stations

02	2 stations
⋮	⋮
20	20 stations

\* This also includes the number of the blanking plate assembly.

• Thread type

—	Rc
F	G

• A, B port size  
Thread piping

Symbol	Port size	Applicable series
02	1/4	SY5000
02	1/4	SY7000

One-touch fitting (Metric size)

Symbol	Port size	Applicable series
C6	One-touch fitting for Ø 6	SY5000
C8	One-touch fitting for Ø 8	
C10	One-touch fitting for Ø 10	SY7000

One-touch fitting (Inch size)

Symbol	Port size	Applicable series
N7	One-touch fitting for Ø 1/4"	SY5000
N9	One-touch fitting for Ø 5/16"	
N11	One-touch fitting for Ø 3/8"	SY7000

• CE-compliant

—	—
Q	CE-compliant

\* AC-type models that are CE-compliant have DIN terminals only.

\* The 25A- series specifications and dimensions are the same as those of the standard model. However, the blanking plate assembly has different dimensions. Refer to page 42.

## How to Order Valves

25A – SY 5 2 40 [ ] [ ] – 5 L [ ] [ ] – [ ]

• Series compatible with secondary batteries

Series

5	SY5000
7	SY7000

Type of actuation

1	2-position single
2	2-position double
3	3-position closed centre
4	3-position exhaust centre
5	3-position pressure centre

Pilot type

—	Internal pilot
R	External pilot

Coil specifications

—	Standard
T	With power saving circuit (24 VDC, 12 VDC only)

\* Power saving circuit is not available in the case of “D” or “Y” type.

Rated voltage

For DC

5	24 VDC
6	12 VDC
V	6 VDC
S	5 VDC
R	3 VDC

For AC (50/60Hz)

1	100 VAC
2	200 VAC
3	110 VAC [115 VAC]
4	220 VAC [230 VAC]

\* DC specifications of type “D” and “Y” are only available with 12 and 24 VDC.

\* AC-type models that are CE-compliant have DIN terminals only.

• CE-compliant

—	—
Q	CE-compliant

\* AC-type models that are CE-compliant have DIN terminals only.

• Manual override

—	Non-locking push type
D	Push-turn locking slotted type
E	Push-turn locking lever type

• Light/surge voltage suppressor

Electrical entry for G, H, L, M

—	Without light/surge voltage suppressor
S	With surge voltage suppressor
Z	With light/surge voltage suppressor
R	With surge voltage suppressor (Non-polar type)
U	With light/surge voltage suppressor (Non-polar type)

\* There is no “S” type for AC mode, since a rectifier prevents surge voltage generation.

\* For “R” and “U,” DC voltage is only available.

\* Power saving circuit is only available in the “Z” type.

Electrical entry for D, Y

—	Without light/surge voltage suppressor
S	With surge voltage suppressor (Non-polar type)
Z	With light/surge voltage suppressor (Non-polar type)

\* There is no “S” type for AC mode, since a rectifier prevents surge voltage generation.

• Electrical entry

24, 12, 6, 5, 3 VDC/100, 110, 200, 220 VAC			24, 12 VDC/ 100, 110, 200, 220 VAC
Grommet	L plug connector	M plug connector	DIN terminal
<b>G:</b> With lead wire (Length 300 mm)	<b>L:</b> With lead wire (Length 300 mm)	<b>M:</b> With lead wire (Length 300 mm)	<b>D:</b> With connector
<b>H:</b> With lead wire (Length 600 mm)	<b>LN:</b> Without lead wire	<b>MN:</b> Without lead wire	<b>Y:</b> With connector
	<b>LO:</b> Without connector	<b>MO:</b> Without connector	

\* “LN,” “MN” type: with 2 sockets.

\* “Y” type is a DIN terminal conforming to EN-175301-803C (former DIN43650C).

\* Refer to the standard products for the lead wire length of L and M plug connectors and the connector assembly with cover for L and M plug connector.

\* The 25A- series specifications and dimensions are the same as those of the standard model.



## How to Order Pilot Valve Assembly

25A-V111   - 5 G  

### Coil specifications

—	Standard
T	With power saving circuit (24 VDC, 12 VDC only)

\* Power saving circuit is not available in the case of D or Y type.

### Rated voltage

5	24 VDC
6	12 VDC
V	6 VDC
S	5 VDC
R	3 VDC
1	100 VAC <sup>50/60</sup> Hz
2	200 VAC <sup>50/60</sup> Hz
3	110 VAC <sup>50/60</sup> Hz [100 VAC <sup>50/60</sup> Hz]
4	220 VAC <sup>50/60</sup> Hz [230 VAC <sup>50/60</sup> Hz]

\* CE-compliant: For DC only.

### Light/Surge voltage suppressor

—	Without light/surge voltage suppressor
S	With surge voltage suppressor
Z	With light/surge voltage suppressor
R	With surge voltage suppressor (Non-polar type)
U	With light/surge voltage suppressor (Non-polar type)

\* For AC voltage valves there is no "S" option. It is already built-in to the rectifier circuit.  
\* For "R" and "U", DC voltage is only available.  
\* Power saving circuit is only available in the "Z" type.

### Electrical entry

G	Grommet, 300 mm lead wire
H	Grommet, 600 mm lead wire
L	L plug connector
LN	With lead wire
LO	Without lead wire
M	M plug connector
MN	With lead wire
MO	Without lead wire

## ■ DIN terminal type

25A-V115 - 5 D  

### Rated voltage

5	24 VDC
6	12 VDC
1	100 VAC <sup>50/60</sup> Hz
2	200 VAC <sup>50/60</sup> Hz
3	110 VAC <sup>50/60</sup> Hz [100 VAC <sup>50/60</sup> Hz]
4	220 VAC <sup>50/60</sup> Hz [230 VAC <sup>50/60</sup> Hz]

\* DC specifications of type D and Y is only available with 12 and 24 VDC.

### Light/Surge voltage suppressor

—	Without light/surge voltage suppressor
S	With surge voltage suppressor (Non-polar type)
Z	With light/surge voltage suppressor (Non-polar type)

\* DOZ and YOZ are not available.  
\* For AC voltage valves there is no "S" option. It is already built-in to the rectifier circuit.

### Electrical entry

D	DIN terminal	With connector
DO	(Type D)	Without connector
Y	DIN terminal	With connector
YO	(Type Y)	Without connector

\* Do not replace V111 (G, H, L, M) to V115 (DIN terminal) and vice versa when replacing pilot valve assembly only.

\* Since V111 and V115 are CE-compliant as standard, the suffix "-Q" is not necessary.

# 25A-SY5000/7000 Series

## One-touch Fittings Part Nos. for Body Ported

		Port size	25A-SY5000	25A-SY7000
Cylinder port	Metric size	Ø 4 One-touch fitting (Straight type)	90-VVQ1000-51A-C4	
		Ø 6 One-touch fitting (Straight type)	90-VVQ1000-51A-C6	
		Ø 8 One-touch fitting (Straight type)	90-VVQ1000-51A-C8	90-VVQ2000-51A-C8
		Ø 10 One-touch fitting (Straight type)		90-VVQ2000-51A-C10

## Gasket Assembly Part Nos.

Valve model	Manifold type	25A-SY5000	25A-SY7000
Body ported	Type 20	SY5000-GS-3	SY7000-GS-3
Base mounted	Type 41/42	SY5000-GS-4 (-Q)	SY7000-GS-4 (-Q)

\* The gasket assembly includes 10 sets of a gasket and mounting screws.

## Bracket Assembly Part Nos.

Description	Part no.
Bracket (For F1)	25A-SX <sup>5</sup> 000-16-2A (With mounting screw)
Bracket (For F2)	25A-SX <sup>5</sup> 000-16-1A (With mounting screw)

## Port Block Assembly Part Nos.

25A-SY **5** 000-6A-**01**   

### Series

5	25A-SY5000
7	25A-SY7000

### Thread type

—	Rc
F	G

### A, B port size

#### Thread piping

Symbol	Port size	Applicable series
01	1/8	25A-SY5000
02	1/4	25A-SY7000

#### One-touch fitting (Metric size)

Symbol	Port size	Applicable series
C4	One-touch fitting for Ø 4	25A-SY5000
C6	One-touch fitting for Ø 6	
C8	One-touch fitting for Ø 8	
C8	One-touch fitting for Ø 8	25A-SY7000
C10	One-touch fitting for Ø 10	

# 25A-SY5000/7000 Series

## Manifold Options

### Blanking plate assembly

(Mounting screw: 2 pcs., with gasket)

It is used by attaching on the manifold block for being prepared for removing a valve for maintenance reasons or planning to mount a spare valve, etc.

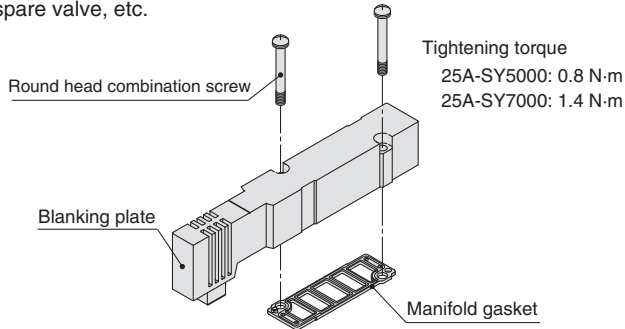

### How to Order

25A-SY **5** 000-26-1A

#### Series

5	25A-SY5000
7	25A-SY7000

### Caution

When mounted on a type 20 manifold, only the P port is plugged. In addition, it cannot be used for the type 20 CE-compliant manifold.

## Dimensions

### Manifold type/For type 20

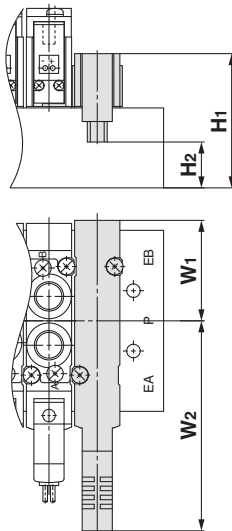

### Manifold type/For type 41/42

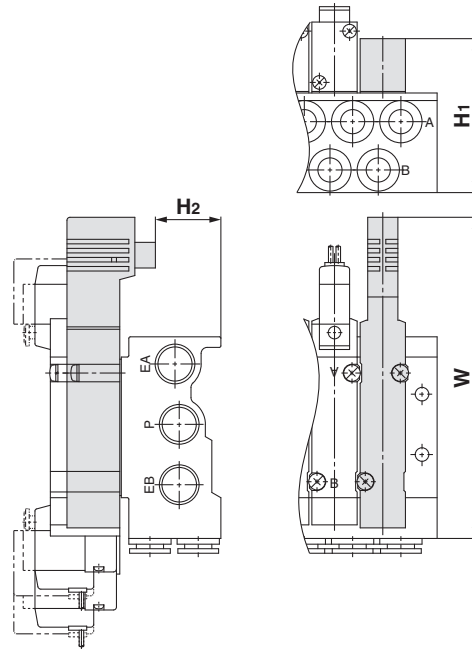

### Dimensions

[mm]

Series	Manifold type	W1	W2	H1	H2
25A-SY5000	Type 20	33.3	69.6	44.5	15.2
25A-SY7000	Type 20	39.4	76.4	41.1	18.3

### Dimensions

[mm]

Series	Manifold type	W	H1	H2
25A-SY5000	Type 41	106.4	51	21.7
	Type 42	107.6	56	26.7
25A-SY7000	Type 42	118.1	55.6	32.8

# Plug-in Unit/Base Mounted F Kit (D-sub connector kit) 25A-VQ2000 Series



## How to Order Manifold

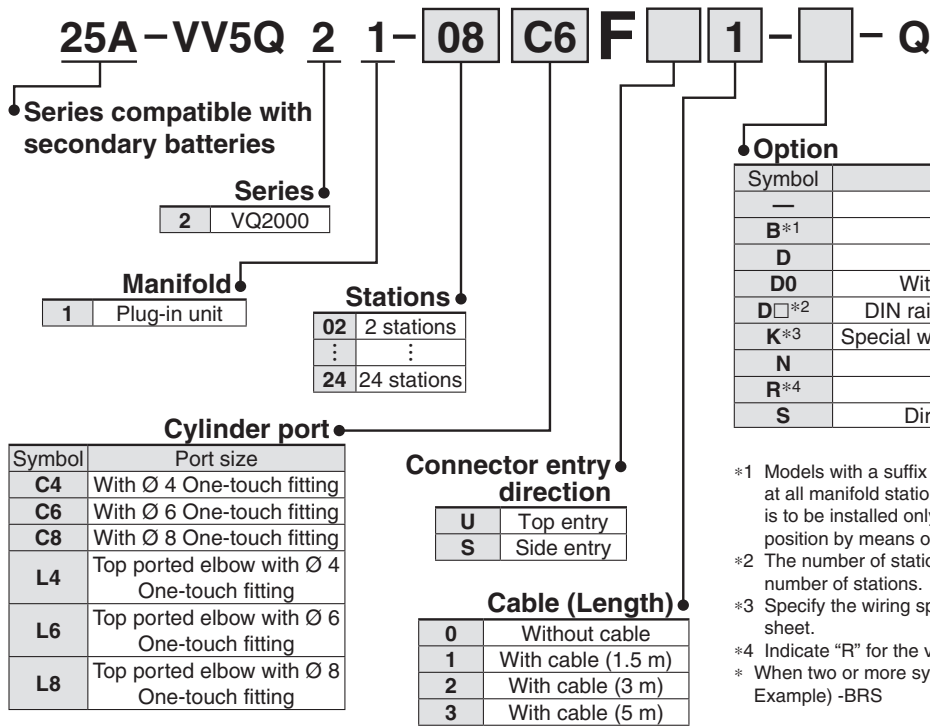

### Option

Symbol	Option
—	None
B*1	With back pressure check valve
D	DIN rail mounting
D0	With DIN rail bracket (Without DIN rail)
D□*2	DIN rail length specified (□: Stations 02 to 24)
K*3	Special wiring specifications (Except double wiring)
N	With name plate
R*4	External pilot
S	Direct EXH outlet with built-in silencer

- \*1 Models with a suffix "-B" have check valves for prevention of back pressure at all manifold stations. When a back pressure check valve is desired, and is to be installed only in certain manifold stations, specify the mounting position by means of the manifold specification sheet.
- \*2 The number of stations that may be displayed is longer than the manifold number of stations.
- \*3 Specify the wiring specifications by means of the manifold specification sheet.
- \*4 Indicate "R" for the valve with external pilot.
- \* When two or more symbols are specified, indicate them alphabetically. Example) -BRS

## How to Order Valves

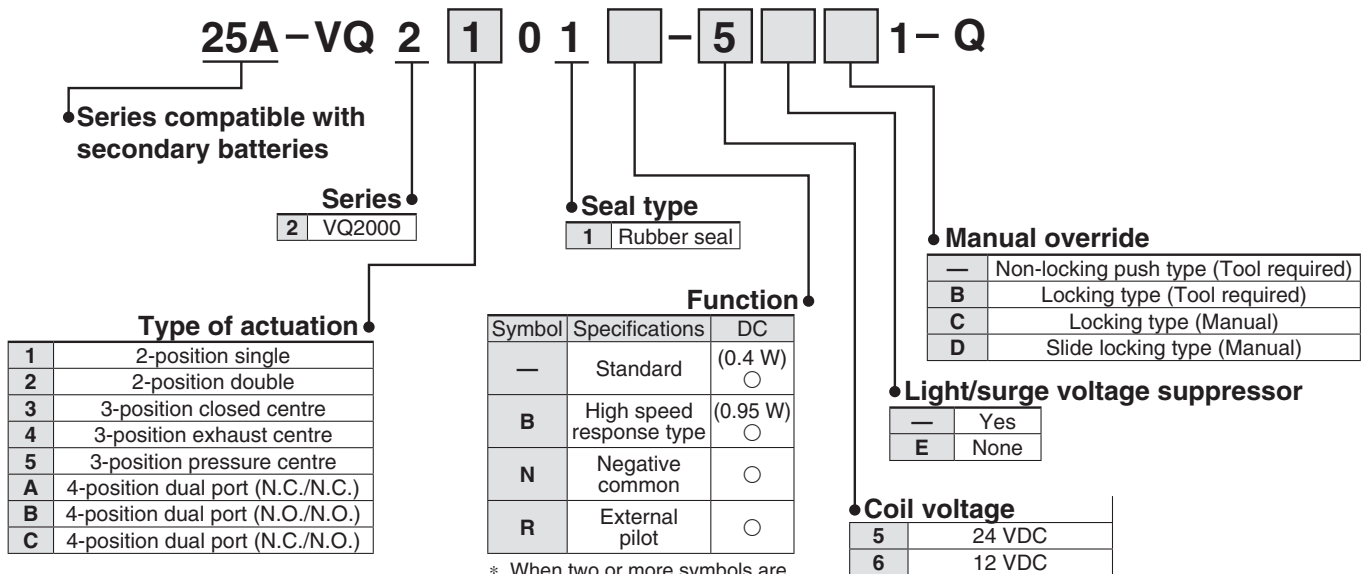

\* When two or more symbols are specified, indicate them alphabetically.

\* The 25A- series specifications and dimensions are the same as those of the standard model.

### ⚠ Caution

Use the standard (DC) specification when continuously energising for long periods of time.

# Plug-in Unit/Base Mounted T Kit (Terminal block box kit) 25A-VQ2000 Series



## How to Order Manifold

25A-VV5Q 2 1 - 08 C6 T 0 - - Q

Series compatible with secondary batteries

Series

2	VQ2000
---	--------

Manifold

1	Plug-in unit
---	--------------

Stations

02	2 stations
⋮	⋮
20	20 stations

Cylinder port

Symbol	Port size
C4	With Ø 4 One-touch fitting
C6	With Ø 6 One-touch fitting
C8	With Ø 8 One-touch fitting
L4	Top ported elbow with Ø 4 One-touch fitting
L6	Top ported elbow with Ø 6 One-touch fitting
L8	Top ported elbow with Ø 8 One-touch fitting

Option

Symbol	Option
—	None
B*1	With back pressure check valve
D	DIN rail mounting
D0	With DIN rail bracket (Without DIN rail)
D□*2	DIN rail length specified (□: Stations 02 to 20)
K*3	Special wiring spec. (Except double wiring)
N	With name plate
R*4	External pilot
S	Direct EXH outlet with built-in silencer
W	Enclosure: Dust-tight, Water-jet-proof (IP65)

- \*1 Models with a suffix "B" have check valves for prevention of back pressure at all manifold stations. When a back pressure check valve is desired, and is to be installed only in certain manifold stations, specify the mounting position by means of the manifold specification sheet.
- \*2 The number of stations that may be displayed is longer than the manifold number of stations.
- \*3 Specify the wiring specifications by means of the manifold specification sheet.
- \*4 Indicate "R" for the valve with external pilot.
- \* When two or more symbols are specified, indicate them alphabetically.  
Example) -BRS
- \* Specify the mounting position by means of the manifold specification sheet.

## How to Order Valves



25A-VQ 2 1 0 1 - 5 - - - 1 - Q

Series compatible with secondary batteries

Series

2	VQ2000
---	--------

Type of actuation

1	2-position single
2	2-position double
3	3-position closed centre
4	3-position exhaust centre
5	3-position pressure centre
A	4-position dual port (N.C./N.C.)
B	4-position dual port (N.O./N.O.)
C	4-position dual port (N.C./N.O.)

Seal type

1	Rubber seal
---	-------------

Function

Symbol	Specifications	DC
—	Standard	(0.4 W) ○
B	High speed response type	(0.95 W) ○
N	Negative common	○
R	External pilot	○

Enclosure

—	Dustproof
W	Dust-tight/Water-jet-proof type (IP65)

Manual override

—	Non-locking push type (Tool required)
B	Locking type (Tool required)
C	Locking type (Manual)
D	Slide locking type (Manual)

Light/surge voltage suppressor

—	Yes
E	None

Coil voltage

5	24 VDC
6	12 VDC

**Caution**  
Use the standard (DC) specification when continuously energising for long periods of time.

\* When two or more symbols are specified, indicate them alphabetically. Combination of "B" and "K" is not possible.

\* The 25A- series specifications and dimensions are the same as those of the standard model.



# Plug-in Unit/Base Mounted L Kit (Lead wire) 25A-VQ2000 Series



## How to Order Manifold

**25A-VV5Q 2 1-06 C6 L 1 - - Q**

- Series compatible with secondary batteries**
- Series**  
2 VQ2000
- Manifold**  
1 Plug-in unit
- Stations**  
01 1 station  
: :  
08 8 stations
- Cylinder port**
- Cable (Length)**  
0 Cable length 0.6 m  
1 Cable length 1.5 m  
2 Cable length 3 m
- Option**

Symbol	Option
—	None
B*1	With back pressure check valve
D	DIN rail mounting
D0	With DIN rail bracket (Without DIN rail)
D□*2	DIN rail length specified (□: Stations 02 to 08)
N	With name plate
R*3	External pilot
S	Direct EXH outlet with built-in silencer
W	Enclosure: Dust-tight, Water-jet-proof (IP65)

Symbol	Port size
C4	With Ø 4 One-touch fitting
C6	With Ø 6 One-touch fitting
C8	With Ø 8 One-touch fitting
L4	Top ported elbow with Ø 4 One-touch fitting
L6	Top ported elbow with Ø 6 One-touch fitting
L8	Top ported elbow with Ø 8 One-touch fitting

\*1 Models with a suffix “-B” have check valves for prevention of back pressure at all manifold stations. When a back pressure check valve is desired, and is to be installed only in certain manifold stations, specify the mounting position by means of the manifold specification sheet.  
\*2 The number of stations that may be displayed is longer than the manifold a number of stations.  
\*3 Indicate “R” for the valve with external pilot.  
\* When two or more symbols are specified, indicate them alphabetically.  
Example) -BRS



## How to Order Valves

**25A-VQ 2 1 0 1 - 5 - - - 1-Q**

- Series compatible with secondary batteries**
- Series**  
2 VQ2000
- Type of actuation**  
1 2-position single  
2 2-position double  
3 3-position closed centre  
4 3-position exhaust centre  
5 3-position pressure centre  
A 4-position dual port (N.C./N.C.)  
B 4-position dual port (N.O./N.O.)  
C 4-position dual port (N.C./N.O.)
- Seal type**  
1 Rubber seal
- Function**
- Enclosure**  
— Dustproof  
W Dust-tight/Water-jet-proof type (IP65)
- Manual override**  
— Non-locking push type (Tool required)  
B Locking type (Tool required)  
C Locking type (Manual)  
D Slide locking type (Manual)
- Light/surge voltage suppressor**  
— Yes  
E None
- Coil voltage**  
5 24 VDC  
6 12 VDC

Symbol	Specifications	DC
—	Standard	(0.4 W) ○
B	High speed response type	(0.95 W) ○
N	Negative common	○
R	External pilot	○

\* When two or more symbols are specified, indicate them alphabetically.

\* The 25A- series specifications and dimensions are the same as those of the standard model.

# Plug-in Unit/Base Mounted S Kit (Serial transmission) 25A-VQ2000 Series



## How to Order Manifold

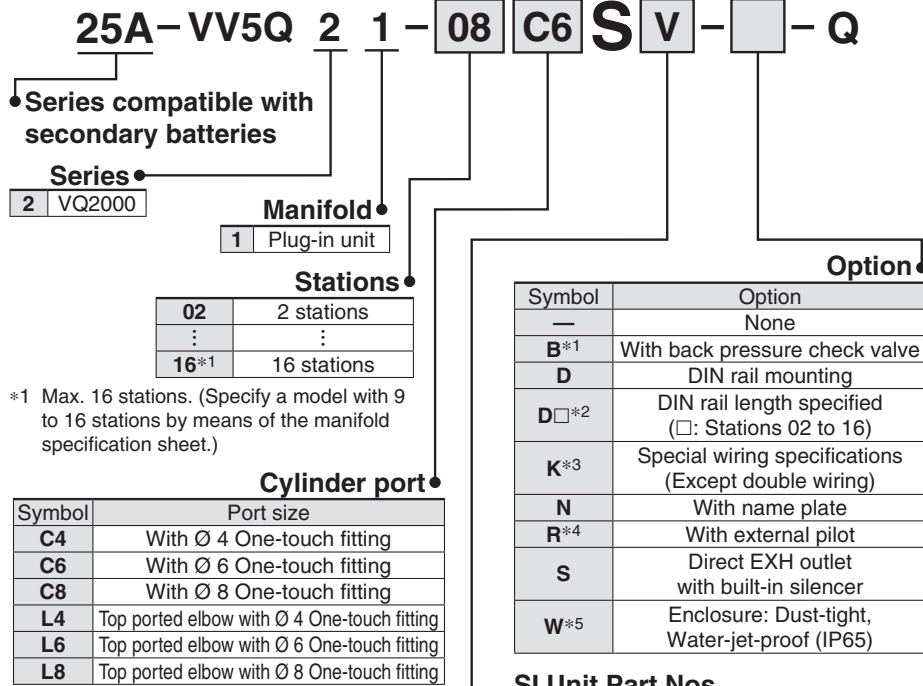

- \*1 Models with a suffix "-B" have check valves for prevention of back pressure at all manifold stations. When a back pressure check valve is desired, and is to be installed only in certain manifold stations, specify the mounting position by means of the manifold specification sheet.
  - \*2 The number of stations that may be displayed is longer than the manifold number of stations.
  - \*3 Specify the wiring specifications by means of the manifold specification sheet.
  - \*4 Indicate "R" for the valve with external pilot.
  - \*5 Refer to "Dimensions" of the standard products for SI unit and valve, in case of "W" (Dust-tight, Water-jet-proof).
- \* When two or more symbols are specified, indicate them alphabetically.  
Example) -BRS.

Symbol	Port size
C4	With Ø 4 One-touch fitting
C6	With Ø 6 One-touch fitting
C8	With Ø 8 One-touch fitting
L4	Top ported elbow with Ø 4 One-touch fitting
L6	Top ported elbow with Ø 6 One-touch fitting
L8	Top ported elbow with Ø 8 One-touch fitting

SI unit specifications		
Symbol	Protocol	Stations
0	Without SI unit	—
Q	DeviceNet™ System	Max.16 stations
V	CC-Link	Max.16 stations

SI Unit Part Nos.		
Symbol	Protocol	SI unit part no.
Q	DeviceNet™	EX120-SDN1-X220
V	CC-Link	EX120-SMJ1-X220

SI Unit Part Nos. (With option W)		
Symbol	Protocol	SI unit part no.
Q	DeviceNet™	EX124D-SDN1-X220
V	CC-Link	EX124D-SMJ1-X220



## How to Order Valves

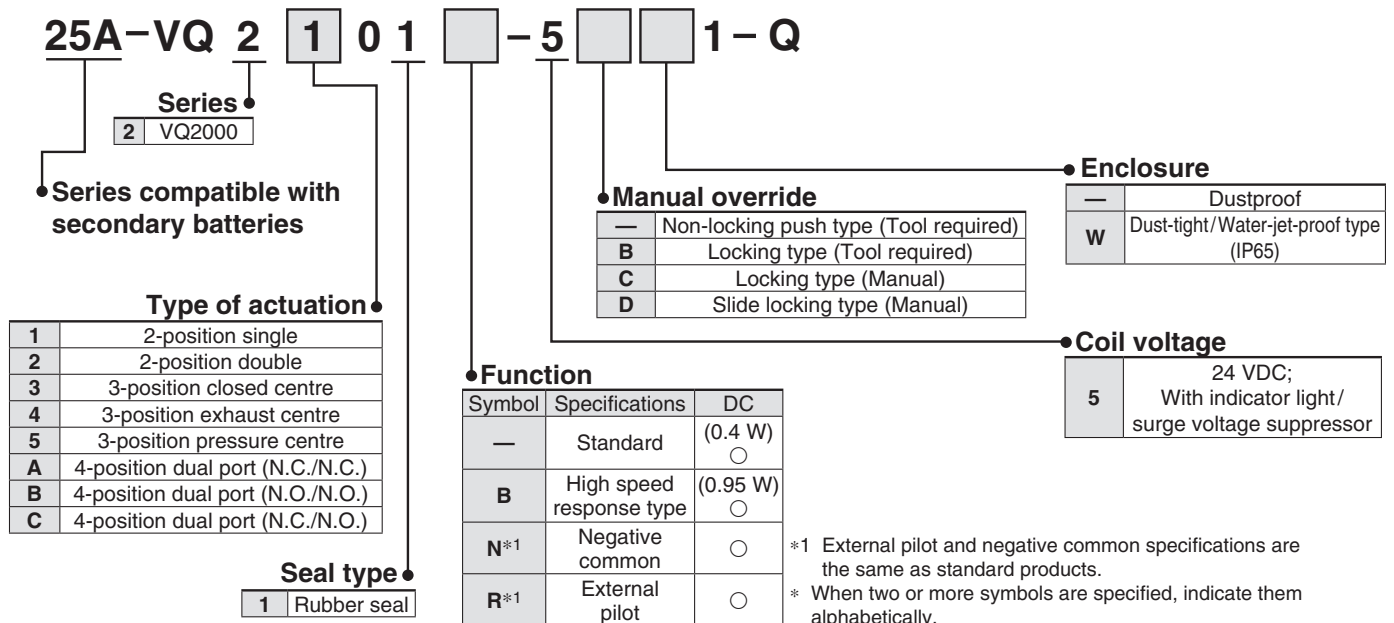

\* The 25A- series specifications and dimensions are the same as those of the standard model.

# Sub-plate Single Unit 25A-VQ2000 Series



## How to Order

In the case of **Valve** + **Sub-plate**

25A-VQ2 **1** **0** **1**-**5** **W** 1-**02** **□**-Q

Series compatible with secondary batteries

Entry is the same as standard products.

Enclosure

—	Dustproof
W*1	Dust-tight/Water-jet-proof type (IP65)

\*1 Valves are IP65 specifications.

Thread type

—	Rc
N	NPT
T	NPTF
F	G

Port size

02	1/4
----	-----

In the case of **Sub-plate** alone

25A-VQ2000-PW-02

\* The 25A- series specifications and dimensions are the same as those of the standard model.

## Manifold Options

### Blanking plate assembly

#### 25A-VVQ2000V-10A-1

It is used by attaching on the manifold block for being prepared for removing a valve for maintenance reasons or planning to mount a spare valve, etc.

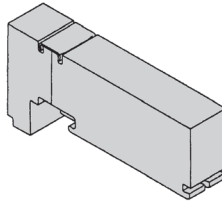

\* The 25A- series specifications and dimensions are the same as those of the standard model.

### SI Unit Part Nos.

Description	SI unit part no.	Note
EX124 SI unit	<b>EX124D-SMJ1-X220</b>	CC-Link
	<b>EX124D-SDN1-X220</b>	DeviceNet™
EX120 SI unit	<b>EX120-SMJ1-X220</b>	CC-Link (VQ2000/Without option "W")
	<b>EX120-SDN1-X220</b>	DeviceNet™ (VQ2000/Without option "W")

### One-touch Fittings Part Nos.

Port size		One-touch fitting part no.	
Cylinder port	Metric size	Ø 4 One-touch fitting (Straight type)	<b>90-VVQ1000-51A-C4</b>
		Ø 6 One-touch fitting (Straight type)	<b>90-VVQ1000-51A-C6</b>
		Ø 8 One-touch fitting (Straight type)	<b>90-VVQ1000-51A-C8</b>
1 (P), 3 (R) port	Metric size	Ø 10 One-touch fitting (Straight type)	<b>90-VVQ2000-51A-C10</b>

# Plug-in/Plug Lead: Single Unit Base Mounted 25A-VQ4000 Series



## How to Order Valves

**0: Plug-in sub-plate**

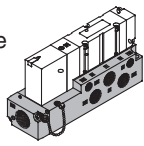

**Body**

**Porting specifications**

—	Side ported
<b>B</b>	Bottom ported

**Port size**

—	Without sub-plate (For manifold)
<b>02</b>	Rc 1/4
<b>03</b>	Rc 3/8

\* Thread standard is the same as standard products.

**Plug-in** 25A-VQ4 1 0 1 □ - 5 □ □ □ 1 - □ □ - Q

**Plug lead** 25A-VQ4 2 5 1 □ - 5 □ □ □ □ 1 - □ □ - Q

**Series compatible with secondary batteries**

**Type of actuation**

<b>1</b>	2-position single
<b>2</b>	Rubber/2-position double
<b>3</b>	3-position closed centre
<b>4</b>	3-position exhaust centre
<b>5</b>	3-position pressure centre
<b>6*1</b>	3-position double check

\*1 For double check type, refer to the Catalogue at [www.smc.eu](http://www.smc.eu).

**Enclosure**

—	Dustproof
<b>W</b>	Dust-tight/Water-jet-proof type (IP65)

**Manual override**

—: Non-locking push type (Tool required)    **B**: Slotted locking type (Tool required)    **C**: Locking type (Manual)

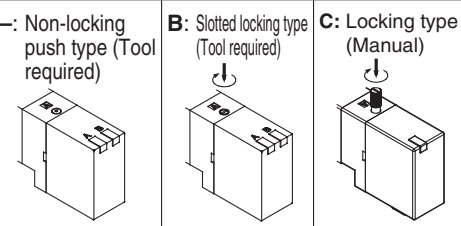

**Light/Surge voltage suppressor**

—	Yes
<b>E</b>	Without light, with surge voltage suppressor

**Electrical entry**

Grommet	<b>G</b>	Lead wire length 0.6 m
	<b>H</b>	Lead wire length 1.5 m

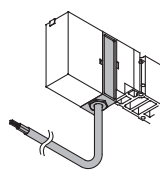

**Seal type**

<b>1</b>	Rubber seal
----------	-------------

**Function**

—*1	Standard type (0.95 W)
<b>Y</b>	Low wattage type (0.4 W)
<b>R*2</b>	External pilot

\*1 When the unit is energised continuously, refer to the Operation Manual.  
\*2 External pilot specifications are the same as standard products. Combination of external pilot and perfect interface is not possible.  
\* When two or more symbols are specified, indicate them alphabetically.

**5: Plug lead sub-plate**

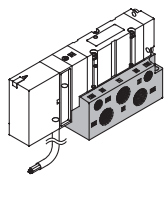

## How to Order Sub-plates

25A-VQ4000 - □ □ - □ □ - Q

**Series compatible with secondary batteries**

**Electrical entry**

<b>P</b>	Plug-in conduit terminal
<b>S</b>	Plug lead

**Enclosure**

—	Dustproof
<b>W*1</b>	Dust-tight/Water-jet-proof type

\*1 It is not necessary for plug lead type.

**Porting specifications**

—	Side ported
<b>B</b>	Bottom ported*1

\*1 For bottom ported port size is Rc 1/4 only.  
\* Thread standard is the same as standard products.

**Port size**

<b>02</b>	Rc1/4
<b>03</b>	Rc3/8

\* The 25A- series specifications and dimensions are the same as those of the standard model.

# Plug-in Unit/Base Mounted F Kit (D-sub connector kit) 25A-VQ4000 Series



## How to Order Manifold

**25A – VV5Q 4 1 – 08 C8 F U 1 – □ – Q**

- Series compatible with secondary batteries**
- Series**

4	VQ4000
---	--------
- Manifold**

1	Plug-in unit
---	--------------
- Stations**

01	1 station
⋮	⋮
18	18 stations
- Cylinder port**

C6	With One-touch fitting for Ø 6
C8	With One-touch fitting for Ø 8
C10	With One-touch fitting for Ø 10
C12	With One-touch fitting for Ø 12
02	Rc 1/4
03	Rc 3/8
B	Bottom ported Rc 1/4
CM	Mixed

\* As a semi-standard specification, the maximum number of stations can be increased by special wiring specifications.
- Option**

Symbol	Option
—	None
K*1	Special wiring specifications (Except double wiring)

\*1 Specify the wiring specifications on the manifold specification sheet.
- Cable (Length)**

0	Without cable
1	Cable length 1.5 m
2	Cable length 3 m
3	Cable length 5 m
- Connector entry direction**

D	D side entry
U	U side entry



## How to Order Valves

**25A – VQ 4 1 0 1 □ – 5 □ □ 1 – Q**

- Series compatible with secondary batteries**
- Series**

4	VQ4000
---	--------
- Type of actuation**

1	2-position single
2	2-position double
3	3-position closed centre
4	3-position exhaust centre
5	3-position pressure centre
6	3-position double check
- Seal type**

1	Rubber seal
---	-------------
- Function**

—*1	Standard (0.95 W)
Y	Low wattage type (0.4 W)
R*2	External pilot

\*1 When the unit is energised continuously, refer to the Operation Manual.  
\*2 External pilot specifications are the same as standard products. Combination of external pilot and perfect interface is not possible.  
\* When two or more symbols are specified, indicate them alphabetically.
- Manual override**

—	Non-locking push type (Tool required)
B	Locking type (Tool required)
C	Locking type (Manual)
- Light/Surge voltage suppressor**

—	Yes
E	Without light, with surge voltage suppressor
- Coil voltage**

5	24 VDC
6	12 VDC

\* The 25A- series specifications and dimensions are the same as those of the standard model.



# Plug-in Unit/Base Mounted T Kit (Terminal block box kit) 25A-VQ4000 Series



## How to Order Manifold

**25A – VV5Q 4 1 – 08 C8 T O – Q**

• Series compatible with secondary batteries

**Series**

4	VQ4000
---	--------

**Manifold**

1	Plug-in unit
---	--------------

**Stations**

03	3 stations
:	:
18	18 stations

\* 2 stations are used for mounting the terminal block box. The number of stations is the number of manifold valves plus 2 stations for the terminal block box. For 13 stations or more, specify the wiring specifications by means of the manifold specification sheet.

**Box mounting position**

O	U side mounting
D	D side mounting

**Cylinder port**

C6	With One-touch fitting for Ø 6
C8	With One-touch fitting for Ø 8
C10	With One-touch fitting for Ø 10
C12	With One-touch fitting for Ø 12
02	Rc 1/4
03	Rc 3/8
B	Bottom ported Rc 1/4
CM	Mixed

\* As a semi-standard specification, the maximum number of stations can be increased by special wiring specifications.

**Option**

Symbol	Option
—	None
K*1	Special wiring specifications (Except double wiring, for 13 stations or more)
N*2	Name plate
W	IP65 enclosure

\*1 Specify the wiring specifications on the manifold specification sheet.  
\*2 Name plate is inlaid in the terminal block cover.  
\* When two or more symbols are specified, indicate them alphabetically. Example) -KM



## How to Order Valves

**25A – VQ 4 1 0 1 – 5 – 1 – Q**

Series compatible with secondary batteries

**Series**

4	VQ4000
---	--------

**Type of actuation**

1	2-position single
2	2-position double
3	3-position closed centre
4	3-position exhaust centre
5	3-position pressure centre
6	3-position double check

**Seal type**

1	Rubber seal
---	-------------

**Function**

—*1	Standard (0.95 W)
Y	Low wattage type (0.4 W)
R*2	External pilot

\*1 When the unit is energised continuously, refer to the Operation Manual.  
\*2 External pilot specifications are the same as standard products. Combination of external pilot and perfect interface is not possible.  
\* When two or more symbols are specified, indicate them alphabetically.

**Enclosure**

—	Dustproof
W	Dust-tight/Water-jet-proof type (IP65)

**Manual override**

—	Non-locking push type (Tool required)
B	Locking type (Tool required)
C	Locking type (Manual)

**Light/Surge voltage suppressor**

—	Yes
E	Without light, with surge voltage suppressor

**Coil voltage**

5	24 VDC
6	12 VDC

\* The 25A- series specifications and dimensions are the same as those of the standard model.

# Plug-in Unit/Base Mounted L Kit (Lead wire cable) 25A-VQ4000 Series



## How to Order Manifold

**25A - VV5Q 4 1 - 08 C8 L D - - Q**

• Series compatible with secondary batteries

**Series**

4	VQ4000
---	--------

**Manifold**

1	Plug-in unit
---	--------------

**Stations**

01	1 station
⋮	⋮
16	16 stations

**Cylinder port**

C6	With One-touch fitting for Ø 6
C8	With One-touch fitting for Ø 8
C10	With One-touch fitting for Ø 10
C12	With One-touch fitting for Ø 12
02	Rc 1/4
03	Rc 3/8
B	Bottom ported Rc 1/4
CM	Mixed

**Option**

Symbol	Option
—	None
W	IP65 enclosure

**Cable (Length)**

0	Cable length 0.6 m
1	Cable length 1.5 m
2	Cable length 3 m

**Connector locations**

D	D side entry
U	U side entry



## How to Order Valves

**25A - VQ 4 1 0 1 - 5 - - - 1 - Q**

• Series compatible with secondary batteries

**Series**

4	VQ4000
---	--------

**Type of actuation**

1	2-position single
2	2-position double
3	3-position closed centre
4	3-position exhaust centre
5	3-position pressure centre
6	3-position double check

**Seal type**

1	Rubber seal
---	-------------

**Function**

—*1	Standard (0.95 W)
Y	Low wattage type (0.4 W)
R*2	External pilot

**Enclosure**

—	Dustproof
W	Dust-tight/Water-jet-proof type (IP65)

**Manual override**

—	Non-locking push type (Tool required)
B	Locking type (Tool required)
C	Locking type (Manual)

**Light /Surge voltage suppressor**

—	Yes
E	Without light, with surge voltage suppressor

**Coil voltage**

5	24 VDC
6	12 VDC

\*1 When the unit is energised continuously, refer to the Operation Manual.  
 \*2 External pilot specifications are the same as standard products. Combination of external pilot and perfect interface is not possible.  
 \* When two or more symbols are specified, indicate them alphabetically.

\* The 25A- series specifications and dimensions are the same as those of the standard model.

# Plug-in Unit/Base Mounted S Kit (Serial transmission unit) 25A-VQ4000 Series



## How to Order Manifold

**25A - VV5Q 4 1 - 08 C8 S D V - [ ] - Q**

• Series compatible with secondary batteries

**Series**

4	VQ4000
---	--------

**Manifold**

1	Plug-in unit
---	--------------

**Stations**

03	3 stations
⋮	⋮
18	18 stations

\* 2 stations are used for mounting SI unit. The number of stations is the number of manifold valves plus 2 stations for SI unit. For 11 stations or more, specify the wiring specifications by means of the manifold specification sheet.

**Cylinder ports**

C6	With One-touch fitting for Ø 6
C8	With One-touch fitting for Ø 8
C10	With One-touch fitting for Ø 10
C12	With One-touch fitting for Ø 12
02	Rc 1/4
03	Rc 3/8
B	Bottom ported Rc 1/4
CM	Mixed

**Option**

Symbol	Option
—	None
K*1	Special wiring specifications (Except double wiring, for 11 stations or more)
W	IP65 enclosure

\*1 Specify the wiring specifications on the manifold specification sheet.  
\* When two or more symbols are specified, indicate them alphabetically. Example) -KW

**SI unit**

0	Without SI unit
Q	DeviceNet™
V	CC-Link

**SI unit mounting position**

—	U side mounting
D	D side mounting



## How to Order Valves

**25A - VQ 4 1 0 1 [ ] - 5 [ ] [ ] [ ] 1 - Q**

Series compatible with secondary batteries

**Series**

4	VQ4000
---	--------

**Type of actuation**

1	2-position single
2	2-position double
3	3-position closed centre
4	3-position exhaust centre
5	3-position pressure centre
6	3-position double check

**Seal type**

1	Rubber seal
---	-------------

**Function**

—*1	Standard (0.95 W)
Y	Low wattage type (0.4 W)
R*2	External pilot

\*1 When the unit is energised continuously, refer to the Operation Manual.  
\*2 External pilot specifications are the same as standard products. Combination of external pilot and perfect interface is not possible.  
\* When two or more symbols are specified, indicate them alphabetically.

**Enclosure**

—	Dustproof
W	Dust-tight/Water-jet-proof type (IP65)

**Manual override**

—	Non-locking push type (Tool required)
B	Locking type (Tool required)
C	Locking type (Manual)

**Light /Surge voltage suppressor**

—	Yes
E	Without light, with surge voltage suppressor

**Coil voltage**

5	24 VDC
---	--------

\* The 25A- series specifications and dimensions are the same as those of the standard model.

# Plug Lead Unit/Base Mounted C Kit (Connector kit) 25A-VQ4000 Series

## How to Order Manifold

25A - VV5Q 4 5 - 08 C8 C - W - Q

Series compatible with secondary batteries

Series

4 VQ4000

Manifold

5 Plug lead unit

Stations

01	1 station
⋮	⋮
16	16 stations

Cylinder port

C6	With One-touch fitting for Ø 6
C8	With One-touch fitting for Ø 8
C10	With One-touch fitting for Ø 10
C12	With One-touch fitting for Ø 12
02	Rc 1/4
03	Rc 3/8
B	Bottom ported Rc 1/4
CM	Mixed

Option

Symbol	Option
—	None
W	IP65 enclosure

Kit type

C kit (Connector)

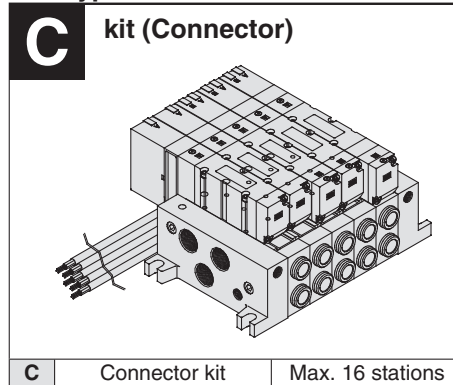

C Connector kit Max. 16 stations

Refer to the Catalogue at [www.smc.eu](http://www.smc.eu) for wiring specifications.

## How to Order Valves

25A - VQ 4 1 5 1 - 5 G - Q

Series compatible with secondary batteries

Series

4 VQ4000

Type of actuation

1	2-position single
2	2-position double
3	3-position closed centre
4	3-position exhaust centre
5	3-position pressure centre
6	3-position double check

Seal type

1 Rubber seal

Function

—*1	Standard (0.95 W)
Y	Low wattage type (0.4 W)
R*2	External pilot

Enclosure

—	Dustproof
W	Dust-tight/Water-jet-proof type (IP65)

Manual override

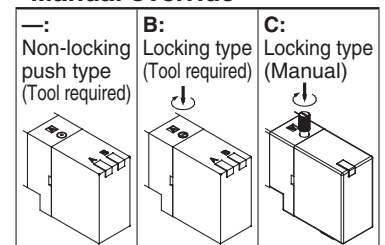

Light/Surge voltage suppressor

—	Yes
E	Without light, with surge voltage suppressor

Electrical entry

Grommet	G	Lead wire length 0.6 m
	H	Lead wire length 1.5 m

Coil voltage

5	24 VDC
6	12 VDC

\*1 When the unit is energised continuously, refer to "Specific Product Precautions 1" on page 533 in the Catalogue at [www.smc.eu](http://www.smc.eu) (VQ4000 series).

\*2 External pilot specifications are the same as standard products. Combination of external pilot and perfect interface is not possible.

\* When two or more symbols are specified, indicate them alphabetically.

\* The 25A-series specifications and dimensions are the same as those of the standard model.

# 25A-VQ4000 Series

## Manifold Options

### Blanking plate assembly

**25A-VVQ4000-10A-1 (Plug-in type)**

**25A-VVQ4000-10A-5 (Plug lead type)**

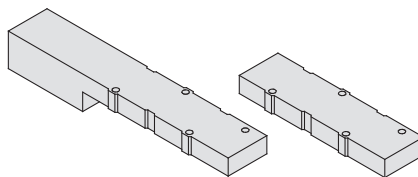

It is used by attaching on the manifold block for being prepared for removing a valve for maintenance reasons or planning to mount a spare valve, etc.

\* The 25A- series specifications and dimensions are the same as those of the standard model.

### SI Unit Part Nos.

Description	SI unit part no.	Note
EX124 SI unit	<b>EX124D-SMJ1-X220</b>	CC-Link/D side mounting
	<b>EX124D-SDN1-X220</b>	DeviceNet™/D side mounting
	<b>EX124U-SMJ1-X220</b>	CC-Link/U side mounting
	<b>EX124U-SDN1-X220</b>	DeviceNet™/U side mounting

### One-touch Fittings Part Nos.

		Port size	One-touch fittings part no.
Cylinder port	Metric size	Ø 6 One-touch fitting (Straight type)	<b>90-VVQ4000-50B-C6</b>
		Ø 8 One-touch fitting (Straight type)	<b>90-VVQ4000-50B-C8</b>
		Ø 10 One-touch fitting (Straight type)	<b>90-VVQ4000-50B-C10</b>
		Ø 12 One-touch fitting (Straight type)	<b>90-VVQ4000-50B-C12</b>

# Plug-in Unit

# 25A-SQ2000 Series



## How to Order Manifold

25A – SS5Q23 – 08 FD2 – D – – – Q

Series compatible with secondary batteries

### Stations

01	1 station
⋮	⋮
16*1	16 stations

\*1 The maximum number of stations depends on the type of electrical entries.

### Manifold mounting

D	DIN rail mounting
E	Direct mounting

### Option

—	None
02 to 16*1	DIN rail length specified
B*2	Back pressure check valve
K*3	Special wiring specifications (Except double wiring)
N	With name plate (Side ported only)
R	External pilot specifications
S	Built-in silencer, direct exhaust

### 1(P), 3(R) port size

—	1(P), 3(R) port One-touch fittings for Ø 10
00T	1(P), 3(R) port One-touch fittings for Ø 3/8"

- \*1 Specify DIN rail length with "D□" at the end. (Enter the number of stations inside □.)  
The number of stations that may be displayed is longer than the manifold number of stations. Example: -D09
- \*2 When "B" is selected, a back pressure check valve is included in all stations of the manifold. If the back pressure check valve is used only for the station that need it, then specify the station location in the manifold specification. ("B" is not necessary)
- \*3 Specify "K" for wiring specification for cases below. (Except L kit)
  - All single wiring
  - Single and double mixed wiring
  - When there are stations which do not require wiring (e.g. single SUP spacer)
 Specify the wiring specification in the manifold specification so that the number of solenoids is the maximum number of solenoids or less. (Standard wiring specification is double wiring)
- \* For specifying two or more options, enter them alphabetically. Example: -BKN

### Electrical entry

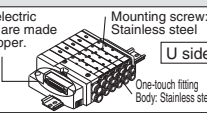
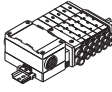
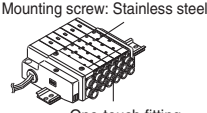
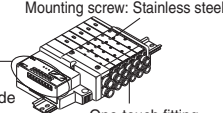
Kit type	Lead wire connector location	Cable specifications	Station	Max. number of stations for special wiring specifications	*1 Max. number of solenoids	
<b>F kit</b> The electric parts are made of copper.  D-sub connector kit	FD0	D-sub connector (25P) kit, without cable	1 to 12 stations	16 stations	24	
	FD1					D-sub connector (25P) kit, with 1.5 m cable
	FD2					D-sub connector (25P) kit, with 3.0 m cable
	FD3					D-sub connector (25P) kit, with 5.0 m cable
<b>T kit</b> Terminal block box kit 	TD0	Terminal block box kit	1 to 10 stations	16 stations	16	
<b>L kit</b> Mounting screw: Stainless steel  Lead wire kit	LD0	Lead wire kit with 0.6 m cable	1 to 12 stations	—	—	
	LU0					Lead wire kit with 1.5 m cable
	LD1					Lead wire kit with 3.0 m cable
	LU1					Lead wire kit with 3.0 m cable
	LD2					Lead wire kit with 3.0 m cable
	LU2					Lead wire kit with 3.0 m cable
<b>S kit</b> Mounting screw: Stainless steel The electric parts are made of copper.  Serial transmission kit EX140 integrated-type (for output) serial transmission system*2	SDQ	DeviceNet™	1 to 8 stations	16 stations	16	
	SDV	CC-Link	1 to 8 stations	16 stations	16	

\*1 The maximum number of stations should not be more than the maximum number of solenoids. (The number of solenoids are counted as: 1 for single solenoids and 2 for type 3P and 4P double solenoids.)

\*2 Refer to the **Catalogue at [www.smc.eu](http://www.smc.eu)** for the details of EX140 integrated-type (for output) serial transmission system.

### SI unit part nos.

Symbol	Protocol type	SI unit part no.	Page
SDQ	DeviceNet™	EX140-SDN1-X220	p. 60
SDV	CC-Link	EX140-SMJ1-X220	

### Blanking plate assembly

25A-SSQ2000-10A-3

\* The 25A- series specifications and dimensions are the same as those of the standard model.



## How to Order Valves

25A—SQ2 **1** 3 1   — **5**   1 — **C6** —   —   — **Q**

Series compatible with secondary batteries

### Type of actuation

1	2-position single
2	2-position double (Double solenoid)*1
3	3-position closed centre
4	3-position exhaust centre
5	3-position pressure centre
A	4-position dual 3-port valve (N.C./N.C.)
B	4-position dual 3-port valve (N.O./N.O.)
C	4-position dual 3-port valve (N.C./N.O.)

\*1 For double solenoid specification, the function symbol below is "D."

### Seal type

1	Rubber seal
---	-------------

### Function

—	Standard (0.4 W DC)
B	Quick response type (0.95 W)
D*1	2-position double (Double solenoid specifications)
N*2	Negative common
R*3	External pilot specifications

\*1 "D" is specified for 2-position double.  
 \*2 For L kit, when the manifold specifies negative common, the valve common should also be negative.  
 \*3 Except dual 3-port valves.  
 \* When two or more symbols are specified, indicate them alphabetically.

### With/Without manifold block

—	M	MB
Without manifold block	With manifold block	With manifold block, built-in back pressure check valve
	* Lead wire is not included.	* Lead wire is not included.
<ul style="list-style-type: none"> <li>When ordering with manifolds</li> <li>When only valves are required.</li> </ul>	For adding stations	

### Port plug mounting port

—	None
A	Port 4(A)
B	Port 2(B)

### Cylinder port

C4	One-touch fittings for Ø 4	Side ported	
C6	One-touch fittings for Ø 6		
C8	One-touch fittings for Ø 8		
L4	One-touch fittings for Ø 4	Top ported *1	
L6	One-touch fittings for Ø 6		
L8	One-touch fittings for Ø 8		

\*1 Can be changed to side ported configuration.

### Manual override

—	B	D
Non-locking push type (Tool required)	Locking type (Tool required)	Slide locking type (Manual type) * Only side ported type applicable

### Coil voltage

5	24 VDC
6	12 VDC

\* Light/Surge voltage suppressor is built-in.  
 \* S kit: 24 VDC only

\* The 25A- series specifications and dimensions are the same as those of the standard model.

# Plug Lead Unit

# 25A-SQ2000 Series



## How to Order Manifold

25A – SS5Q24 – 08 FD2 – D □ – □ – Q

Series compatible with secondary batteries

### Stations

01	1 station
⋮	⋮
16*1	16 stations

\*1 The maximum number of stations depends on the type of electrical entries.

### 1(P), 3(R) port size

—	1(P), 3(R) port, One-touch fittings for Ø 10
00T	1(P), 3(R) port, One-touch fittings for Ø 3/8"

### Option

—	None
02 to 16*1	DIN rail length specified
B*2	Back pressure check valve
K*3	Special wiring specifications (Except double wiring)
N	With name plate (Side ported only)
R	External pilot specifications
S	Built-in silencer, direct exhaust

### Manifold mounting

D	DIN rail mounting
E*1	Direct mounting

\*1 Type "E" is only available with a C kit.

- \*1 Specify DIN rail length with "D□" at the end. (Enter the number of stations inside □.)  
The number of stations that may be displayed is longer than the manifold number of stations. Example: -D09
- \*2 When "-B" is selected, a back pressure check valve is included in all stations of the manifold. If the back pressure check valve is used only for the station that need it, then specify the station location in the manifold specification. ("-B" is not necessary)
- \*3 Specify "-K" for wiring specification for cases below. (Except C kit)  
- All single wiring - Single and double mixed wiring  
Specify the wiring specification in the manifold specification so that the number of solenoids is the maximum number of solenoids or less. (Standard wiring specification is double wiring)
- \* For specifying two or more options, enter them alphabetically. Example: -BKN

### Electrical entry

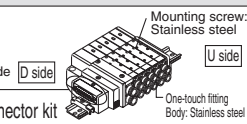
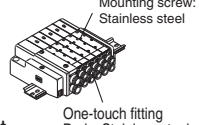
Kit type	Lead wire connector location	Cable specifications	Stations	Max. number of stations for special wiring specifications	Max. number of solenoids *1
<b>F kit</b>  The electric parts are made of copper. D-sub connector kit	D side	FD0	D-sub connector (25P) kit, without cable	1 to 12 stations	16 stations
		FD1	D-sub connector (25P) kit, with 1.5 m cable		
		FD2	D-sub connector (25P) kit, with 3.0 m cable		
		FD3	D-sub connector (25P) kit, with 5.0 m cable		
<b>C kit</b>  Connector kit	C	—	Connector kit	1 to 16 stations	—

\*1 The maximum number of stations should not be more than the maximum number of solenoids. (The number of solenoids are counted as: 1 for single solenoids and 2 for type 3P and 4P double solenoids.)

\* Refer to the **Catalogue at [www.smc.eu](http://www.smc.eu)** for manifold spare parts.

### Blanking plate assembly

25A-SSQ2000-10A-4

\* The 25A- series specifications and dimensions are the same as those of the standard model.

## How to Order Valves

25A—SQ2 **1** 4 1    — **5** **L**    1 — **C6** —    —    — **Q**

Series compatible with secondary batteries

### Type of actuation

1	2-position single
2	2-position double (Double solenoid)*1
3	3-position closed centre
4	3-position exhaust centre
5	3-position pressure centre
A	4-position dual 3-port valve (N.C./N.C.)
B	4-position dual 3-port valve (N.O./N.O.)
C	4-position dual 3-port valve (N.C./N.O.)

\*1 For double solenoid specification, the function symbol below is "D."

### Seal type

1	Rubber seal
---	-------------

### Function

—	Standard (0.4 W DC)
B	Quick response type (0.95 W)
D*1	2-position double (Double solenoid specifications)
N	Negative COM
R*2	External pilot specifications

\*1 "D" is specified for 2-position double.

\*2 Except dual 3-port valves.

\* When two or more symbols are specified, indicate them alphabetically.

### Coil voltage

5	24 VDC
6	12 VDC

\* Light/Surge voltage suppressor is built-in.

### With/Without manifold block

—	M	MB
Without manifold block	With manifold block	With manifold block, built-in back pressure check valve
	* Lead wire is not included.	* Lead wire is not included.
<ul style="list-style-type: none"> <li>When ordering with manifolds</li> <li>When only valves are required.</li> </ul>		
For adding stations		

### Port plug mounting port

—	None
A	Port 4(A)
B	Port 2(B)

### Cylinder port

C4	One-touch fitting for Ø 4	Side ported	
C6	One-touch fitting for Ø 6		
C8	One-touch fitting for Ø 8		
L4	One-touch fitting for Ø 4	Top ported *1	
L6	One-touch fitting for Ø 6		
L8	One-touch fitting for Ø 8		

\*1 Can be changed to side ported configuration.

### Manual override

—	B	D
Non-locking push type (Tool required)	Locking type (Tool required)	Slide locking type (Manual type) * Only side ported type applicable

### Electrical entry

L	LO
Plug connector type with 300 mm lead wire	Plug connector type without connector
	For F, P, J kit manifolds*1

\*1 Indicate "LO" when ordering centralised wiring type manifolds, F, P, and J kits, since the lead wire will be attached to the manifold side.

\* The 25A- series specifications and dimensions are the same as those of the standard model.

**SI Unit Part Nos.**

Description	SI unit part no.	Note
EX140 SI unit	<b>EX140-SMJ1-X220</b>	CC-Link
	<b>EX140-SDN1-X220</b>	DeviceNet™

**One-touch Fittings Part Nos.**

Port size			One-touch fittings part no.
Cylinder port	Metric size	Ø 4 One-touch fitting (Straight type)	<b>90-VVQ1000-51A-C4</b>
		Ø 6 One-touch fitting (Straight type)	<b>90-VVQ1000-51A-C6</b>
		Ø 8 One-touch fitting (Straight type)	<b>90-VVQ1000-51A-C8</b>
1 (P), 3 (R) port	Metric size	Ø 10 One-touch fitting (Straight type)	<b>90-VVQ2000-51A-C10</b>

Base Mounted  
Plug Lead Unit

# 5-Port Solenoid Valve

## 25A-VQZ1000 Series

### Single Unit



#### How to Order Valves

**25A-VQZ 1 1 5 1**    - **5 M**    1 - **01** - Q

• Series compatible with secondary batteries

Series

1	VQZ1000 body width 10 mm
---	--------------------------

Type of actuation

1	2-position single
2	2-position double
3	3-position closed centre
4	3-position exhaust centre
5	3-position pressure centre
8	3-port for mixture mounting N.C.
9	3-port for mixture mounting N.O.

Body type

5	Base mounted
---	--------------

Seal type

1	Rubber seal
---	-------------

Function

Symbol	Specifications	DC
—	Standard	(0.35 W) ○
B	High speed response type	(0.9 W) ○
R	External pilot type	○
BR	High speed response/External pilot type	(0.9 W) ○

Port size

Symbol	Port size
—	Without sub-plate
01	Rc1/8

Manual override

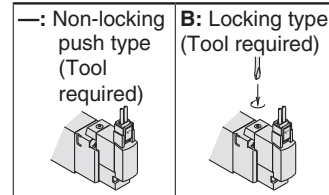

Electrical entry

G: Grommet (DC specification)	L: L-type plug connector with lead wire	LO: L-type plug connector without connector	M: M-type plug connector with lead wire	MO: M-type plug connector without connector
	With light/surge voltage suppressor	With light/surge voltage suppressor	With light/surge voltage suppressor	With light/surge voltage suppressor

Coil voltage

5	24 VDC
6	12 VDC

### ⚠ Caution

Use standard (DC) specification for continuous duty.

\* The 25A- series specifications and dimensions are the same as those of the standard model.

Base Mounted  
Plug Lead Unit

# 5-Port Solenoid Valve

## 25A-VQZ1000 Series

### Manifold Connector Kit



#### How to Order Manifold

**25A-VV5QZ 1 5-08 C6 C-R-Q**

Series compatible with secondary batteries

**Series**  
1 VQZ1000

**Manifold type**  
5 Base mounted

**Stations**  
02 2 stations  
: :  
20 20 stations

**Port size [4(A), 2(B) port]**

Symbol	Port size
C4	Ø 4 One-touch fitting
C6	Ø 6 One-touch fitting
M5	M5 thread
CM*1	Mixture of port sizes

\*1 Specify port mixture/with port plug by the manifold specification sheet. Port mixture and port plug are available only for One-touch fitting type.

**Option**

—	None
R	External pilot type

**Kit type**  
C Connector

#### How to Order Valves

**25A-VQZ 1 1 5 1 - 5 M 1-Q**

Series compatible with secondary batteries

**Series**  
1 VQZ1000 body width 10 mm

**Type of actuation**

1	2-position single
2	2-position double
3	3-position closed centre
4	3-position exhaust centre
5	3-position pressure centre
8	3-port for mixture mounting N.C.
9	3-port for mixture mounting N.O.

**Body type**  
5 Base mounted

**Seal type**  
1 Rubber seal

**Function**

Symbol	Specifications	DC
—	Standard	(0.35 W) ○
B	High speed response type	(0.9 W) ○
R	External pilot type	○
BR	High speed response/ External pilot type	(0.9 W) ○

**Manual override**

—	Non-locking push type (Tool required)
B	Locking type (Tool required)

**Electrical entry**

Symbol	Electrical entry	Light/surge voltage suppressor
G	Grommet (DC specification)	None
L	L-type plug connector with lead wire	Yes
LO	L-type plug connector without connector	
M	M-type plug connector with lead wire	
MO	M-type plug connector without connector	

**Coil voltage**

5	24 VDC
6	12 VDC

**Caution**  
Use standard (DC) specification for continuous duty.

\* The 25A-series specifications and dimensions are the same as those of the standard model.



Body Ported  
Plug Lead Unit

# 5-Port Solenoid Valve

## 25A-VQZ1000 Series

### Single Unit



#### How to Order Valves

**25A-VQZ 1 1 2 1 [ ] - 5 M [ ] 1 - C6 - [ ] - Q**

• Series compatible with secondary batteries

• Series

1 VQZ1000 body width 10 mm

• Type of actuation

1	2-position single
2	2-position double
3	3-position closed centre
4	3-position exhaust centre
5	3-position pressure centre
8	3-port for mixture mounting N.C.
9	3-port for mixture mounting N.O.

\* 3-port for mixture mounting is only available for port size C4 or C6.

• Option

—: None  
F: With bracket 2-position single type only

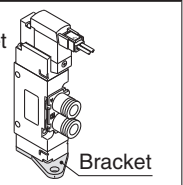

• Port size [4(A), 2(B) port]

Symbol	Port size
C4	Ø 4 One-touch fitting
C6	Ø 6 One-touch fitting
M5	M5 thread

• Manual override

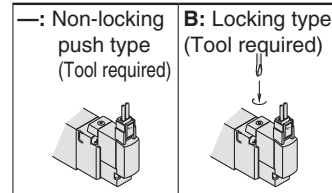

• Electrical entry

G: Grommet (DC specification)	L: L-type plug connector with lead wire	LO: L-type plug connector without connector	M: M-type plug connector with lead wire	MO: M-type plug connector without connector
	With light/surge voltage suppressor	With light/surge voltage suppressor	With light/surge voltage suppressor	With light/surge voltage suppressor

• Body type

2 Body ported

• Seal type

1 Rubber seal

• Function

Symbol	Specifications	DC
—	Standard	(0.35 W) ○
B	High speed response type	(0.9 W) ○

• Coil voltage

5	24 VDC
6	12 VDC

**⚠ Caution**

Use standard (DC) specification for continuous duty.

\* The 25A- series specifications and dimensions are the same as those of the standard model.

Body Ported  
Plug Lead Unit

# 5-Port Solenoid Valve

## 25A-VQZ1000 Series

### Manifold Connector Kit



#### How to Order Manifold

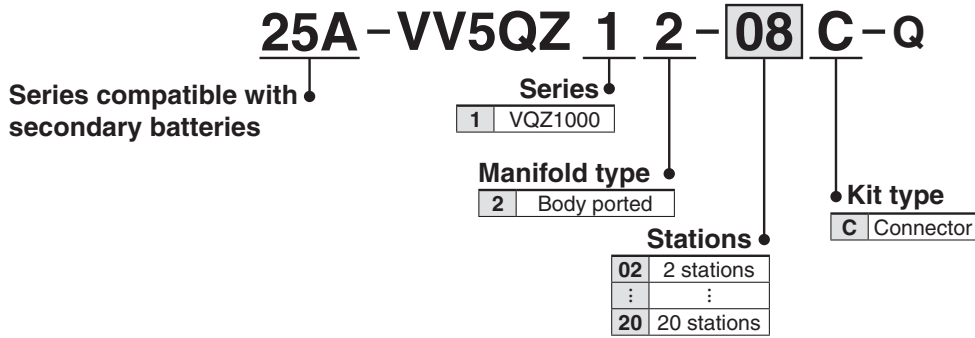

#### How to Order Valves

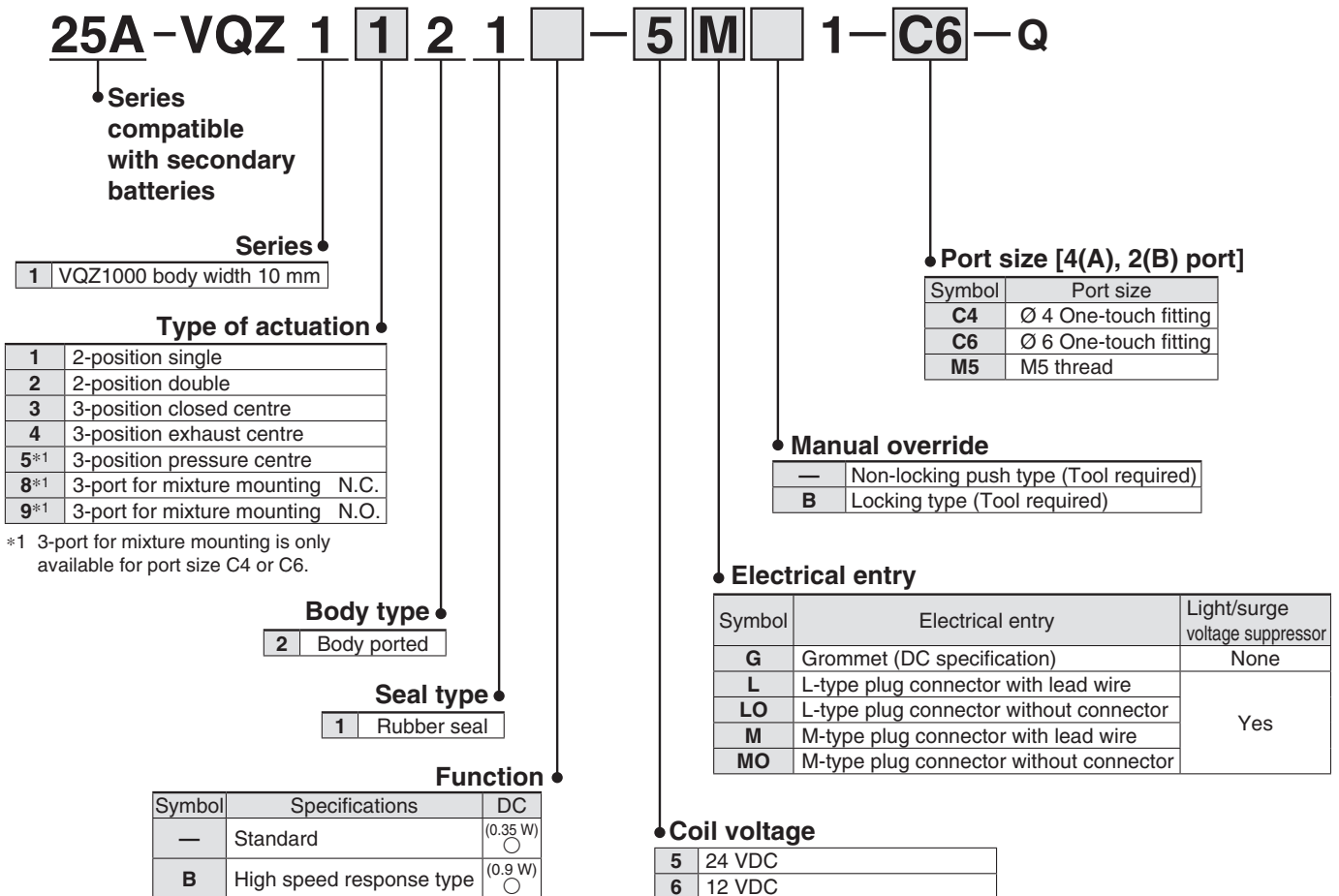

#### ⚠ Caution

Use standard (DC) specification for continuous duty.

\* The 25A- series specifications and dimensions are the same as those of the standard model.

# Plug-in Unit Base Mounted

# 25A-VQ1000/2000 Series

## Double check block (Separated)

### How to Order

Double check block

**25A-VQ1000-FPG-C4M5-F**

• Series compatible with secondary batteries

• IN side port size

M5	M5 thread
C3	Ø 3.2 One-touch fitting
C4	Ø 4 One-touch fitting
C6	Ø 6 One-touch fitting

• OUT side port size

M5	M5 thread
C3	Ø 3.2 One-touch fitting
C4	Ø 4 One-touch fitting
C6	Ø 6 One-touch fitting

• Option

—	None
F	With bracket
D	DIN rail mounting (For manifold)
N	Name plate

\* When two or more symbols are specified, indicate them alphabetically.  
Example) -DN

Manifold (DIN rail mounting)

**25A-VVQ1000-FPG-06**

• Series compatible with secondary batteries

When ordering a double check block, order the DIN rail mounting [-D].

<Ordering example>

25A-VVQ1000-FPG-06...6-station manifold

\* 25A-VQ1000-FPG-C4M5-D; } Double check block  
3 sets  
\* 25A-VQ1000-FPG-C6M5-D; }  
3 sets

• Stations

01	1 station
⋮	⋮
16	16 stations

Bracket Assembly

Part no.	Tightening torque
25A-VQ1000-FPG-FB	0.22 to 0.25 N·m

Double check block

**25A-VQ2000-FPG-0101-F**

• Series compatible with secondary batteries

• IN side port size

01	Rc 1/8
02	Rc 1/4
C6	Ø 6 One-touch fitting
C8	Ø 8 One-touch fitting

• OUT side port size

01	Rc 1/8
02	Rc 1/4
C6	Ø 6 One-touch fitting
C8	Ø 8 One-touch fitting

• Option

—	None
D	DIN rail mounting (For manifold)
F	With bracket
N	Name plate

\* When two or more symbols are specified, indicate them alphabetically.  
Example) -DN

Manifold (DIN rail mounting)

**25A-VVQ2000-FPG-06**

• Series compatible with secondary batteries

When ordering a double check block, order the DIN rail mounting [-D].

<Ordering Example>

25A-VVQ2000-FPG-06...6-station manifold

\* 25A-VQ2000-FPG-C6C6-D; } Double check block  
3 sets  
\* 25A-VQ2000-FPG-C8C8-D; }  
3 sets

• Stations

01	1 station
⋮	⋮
16	16 stations

Bracket Assembly

Part no.	Tightening torque
25A-VQ2000-FPG-FB	0.8 to 1.0 N·m

\* The 25A- series specifications and dimensions are the same as those of the standard model.

# Rubber Seal

## 3-Port/Pilot Poppet Type

# 25A-VP342/542/742 Series

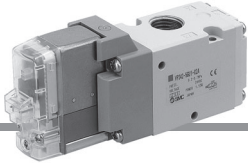

### How to Order

Body ported **25A-VP** **3** **4** **2** **-** **5** **D** **1-01** **A-**

Series compatible with secondary batteries

#### Series

3	VP300
5	VP500
7	VP700

#### Pilot type

—	Internal pilot
R	External pilot

#### Pressure specification

—	Standard (0.7 MPa)
K	High pressure type (1.0 MPa)

#### Coil specification

—	Standard
T	With power saving circuit (DC only)

- \* Be sure to select the power saving circuit type when it is continuously energised for a long time.
- \* "T" type is only available for DC mode. When "T" is selected, only "Z" type of light/surge voltage suppressor is available.

#### Rated voltage

DC		AC (50/60 Hz)	
5	24 VDC	1	100 VAC
6	12 VDC	2	200 VAC
		3	110 VAC [115 VAC]
		4	220 VAC [230 VAC]
		7	240 VAC
		B	24 VAC

#### Electrical entry

DIN terminal	DIN (EN175301-803) terminal	Conduit terminal
[IP65 compatible]	[IP65 compatible]	[IP65 compatible]
D: With connector	Y: With connector	T: Conduit terminal

#### Thread type

—	Rc
F	G
N	NPT
T	NPTF

#### Type of actuation

A	N.C. (Normally closed)
B	N.O. (Normally open)

#### Bracket

—	Without bracket
F	With bracket

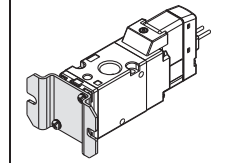

#### Port size

Symbol	Port size	VP300	VP500	VP700
01	1/8	○	—	—
02	1/4	○	○	—
03	3/8	—	○	—
04	1/2	—	—	○

#### Manual override

—: Non-locking push type	D: Push-turn locking slotted type	E: Push-turn locking lever type

#### Light/surge voltage suppressor

		DC	AC
—	Without light/surge voltage suppressor	○	○
S	With surge voltage suppressor	○	—*1
Z	With light/surge voltage suppressor	○	○
R	With surge voltage suppressor (Non-polar)	○	—
U	With light/surge voltage suppressor (Non-polar)	○	—

\*1 There is no "S" type for AC mode, since a rectifier prevents surge voltage generation.

\* The 25A- series specifications and dimensions are the same as those of the standard model.

# Rubber Seal

## 3-Port/Pilot Poppet Type

# 25A-VP344/544/744 Series



### How to Order

Base mounted **25A-VP** **3** **4** **4** **□** **□** **□** **-** **5** **D** **□** **□** **□** **1-** **01** **□** **A**

Series compatible with secondary batteries

#### Series

3	VP300
5	VP500
7	VP700

#### Pilot type

—	Internal pilot
R	External pilot

#### Pressure specifications

—	Standard (0.7 MPa)
K	High pressure type (1.0 MPa)

#### Coil specifications

—	Standard
T	With power saving circuit (DC only)

\* Be sure to select the power saving circuit type when it is continuously energised for a long time.  
 \* "T" type is only available for DC mode. When "T" is selected, only "Z" type of light/surge voltage suppressor is available.

#### Rated voltage

DC		AC (50/60 Hz)	
5	24 VDC	1	100 VAC
6	12 VDC	2	200 VAC
		3	110 VAC [115 VAC]
		4	220 VAC [230 VAC]
		7	240 VAC
		B	24 VAC

#### Thread type

—	Rc
F	G
N	NPT
T	NPTF

#### Type of actuation

A	N.C. (Normally closed)
B	N.O. (Normally open)

#### Port size (Sub-plate)

Symbol	Port size	VP300	VP500	VP700
—	Without sub-plate*1			
01	1/8	○	—	—
02	1/4	○	○	—
03	3/8	—	○	○
04	1/2	—	—	○

\*1 With a gasket and two mounting bolts.

#### Electrical entry

DIN terminal	DIN (EN175301-803) terminal	Conduit terminal
[IP65 compatible]	[IP65 compatible]	[IP65 compatible]
D: With connector	Y: With connector	T: Conduit terminal

#### Manual override

—: Non-locking push type	D: Push-turn locking slotted type	E: Push-turn locking lever type

#### Light/surge voltage suppressor

		DC	AC
—	Without light/surge voltage suppressor	○	○
S	With surge voltage suppressor	○	—*1
Z	With light/surge voltage suppressor	○	○
R	With surge voltage suppressor (Non-polar)	○	—
U	With light/surge voltage suppressor (Non-polar)	○	—

\*1 There is no "S" type for AC mode, since a rectifier prevents surge voltage generation.

\* The 25A- series specifications and dimensions are the same as those of the standard model.

# 3-Port Solenoid Valve/Residual Pressure Release Valve with Detection of Main Valve Position

## 25A-VP500/700-X536, X538, X555

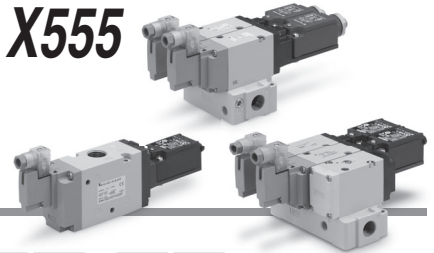

### How to Order

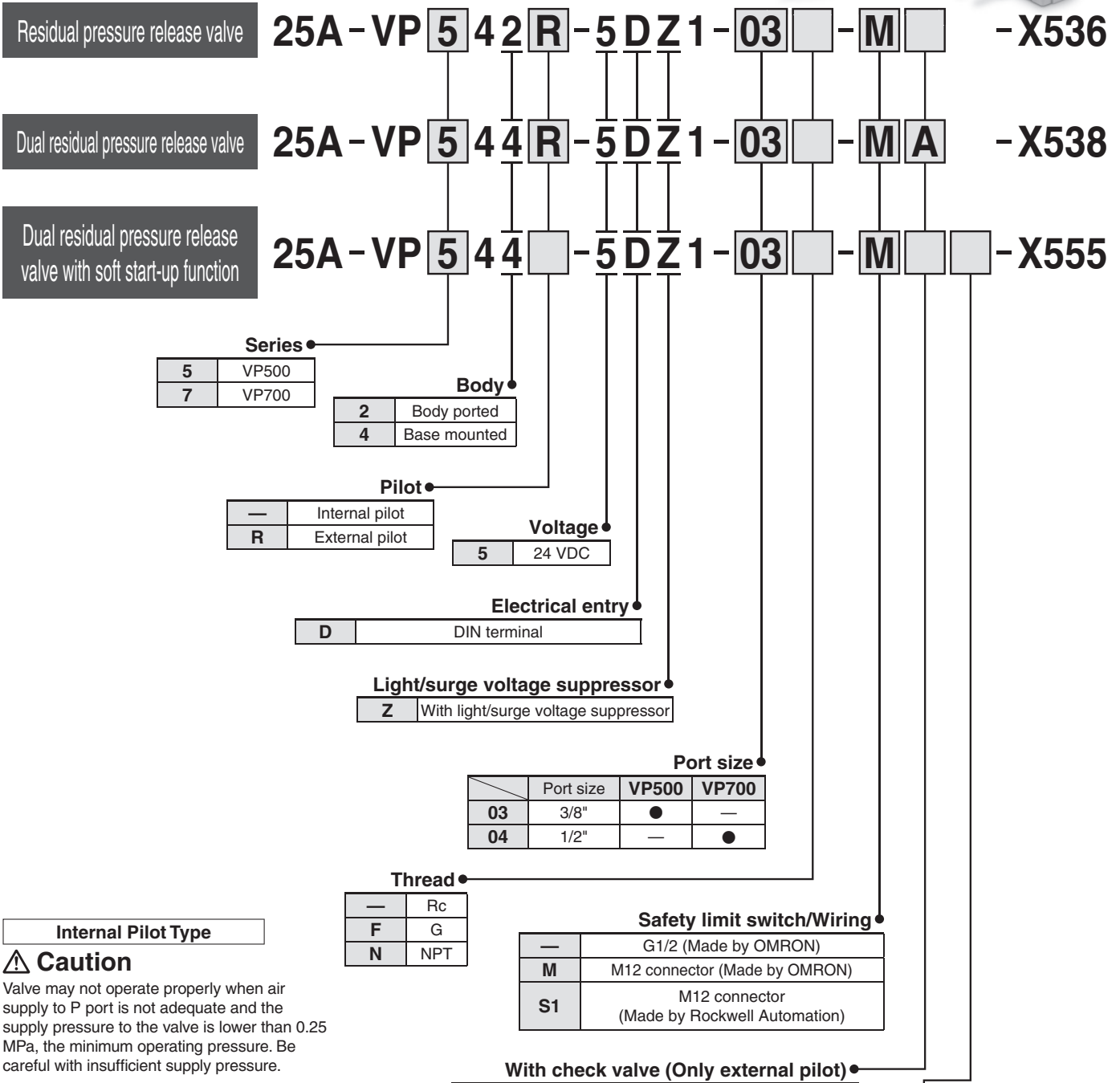

**Internal Pilot Type**

**Caution**

Valve may not operate properly when air supply to P port is not adequate and the supply pressure to the valve is lower than 0.25 MPa, the minimum operating pressure. Be careful with insufficient supply pressure.

**Piping for External Pilot Type**

**Caution**

The product may not operate when the external pilot pressure is insufficient due to simultaneous operation or restricted air piping. In this case, use the check valve (AKH series) with the external pilot port, change the piping size or adjust the set pressure to provide a constant pressure of 0.25 MPa or more.

**Throttle**

<b>—</b>	Variable throttle
<b>10</b>	∅ 1 fixed orifice
<b>15</b>	∅ 1.5 fixed orifice
<b>20</b> <sup>*1</sup>	∅ 2 fixed orifice

\*1 VP700 only

\* For internal pilot, the symbol is —.

\* The 25A- series specifications and dimensions are the same as those of the standard model.



# 3-Port Solenoid Valve Direct Operated Poppet Type 25A-VT317 Series Rubber Seal



## How to Order

25A-V T 317 - 1 G - 02 - Q

### Body type

T	Body ported
O	Manifold

Series compatible with secondary batteries

### Valve option

-	Standard
E*1	Continuous duty type
V*1	For vacuum

\*1 Semi-standard

### Rated voltage

1	100 VAC (50/60 Hz)
2	200 VAC (50/60 Hz)
3*1	110 VAC (50/60 Hz)
4*1	220 VAC (50/60 Hz)
5	24 VDC
6*1	12 VDC
7*1	240 VAC (50/60 Hz)

\*1 Semi-standard

\* Applicable only for DIN terminal type.

### Thread type

-	Rc
F	G
N	NPT
T	NPTF

### Port size

-	Without port (For manifold)
02	1/4 (8A)

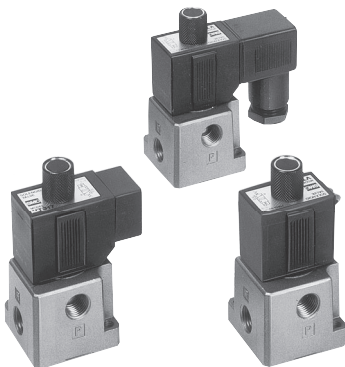

### Electrical entry

D	DIN terminal	CE-compliant
---	--------------	--------------

### Light/Surge voltage suppressor

Electrical entry Symbol	G	H	C	D
-	●	●	●	●
S	●*1	●*1	●*1	●
Z	-	-	-	●

S: With surge voltage suppressor

\*1 Refer to the figure below.

Z: With light/surge voltage suppressor

Surge voltage suppressor mounting part (For "G")

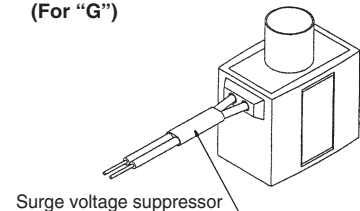

## Manifold

Model	Applicable manifold type	Accessory
VO317(-Q)	Common or individual exhaust	O-ring (KA00066, 4 pcs.)*1 Bolts (XT012-25C#1, 2 pcs.)

\*1 It is not applied to "Continuous duty type." Refer to the accessories in the **Catalogue at [www.smc.eu](http://www.smc.eu)**.

\* The 25A- series specifications and dimensions are the same as those of the standard model.

# 3-Port Solenoid Valve Direct Operated Poppet Type **25A-VG342 Series** Rubber Seal



## Low power consumption

4.8 W DC (Standard type)  
2 W DC (Energy-saving type)

## No lubrication required

## Possible to use in vacuum or under low pressures

External pilot  
Vacuum: Up to -101.2 kPa  
Low pressure: 0 to 0.2 MPa

## Changeable actuation:

N.C., N.O., or external pilot

Can be used as a selector or divider valve (External pilot)

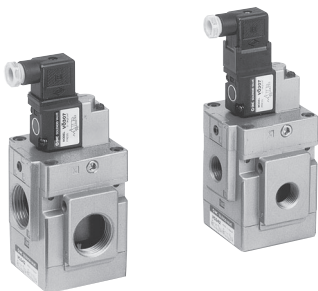

## How to Order

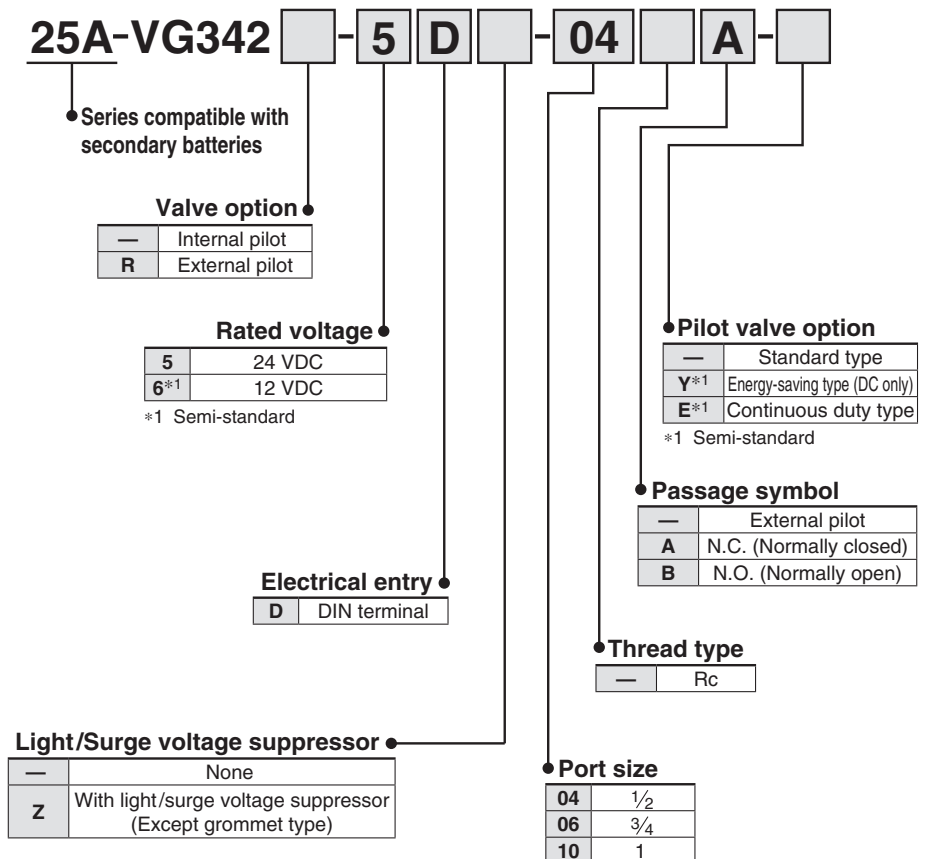

\* The 25A- series specifications and dimensions are the same as those of the standard model.

# 5-Port Air Operated Valve

RoHS

# 25A-SYA5000/7000 Series

## How to Order

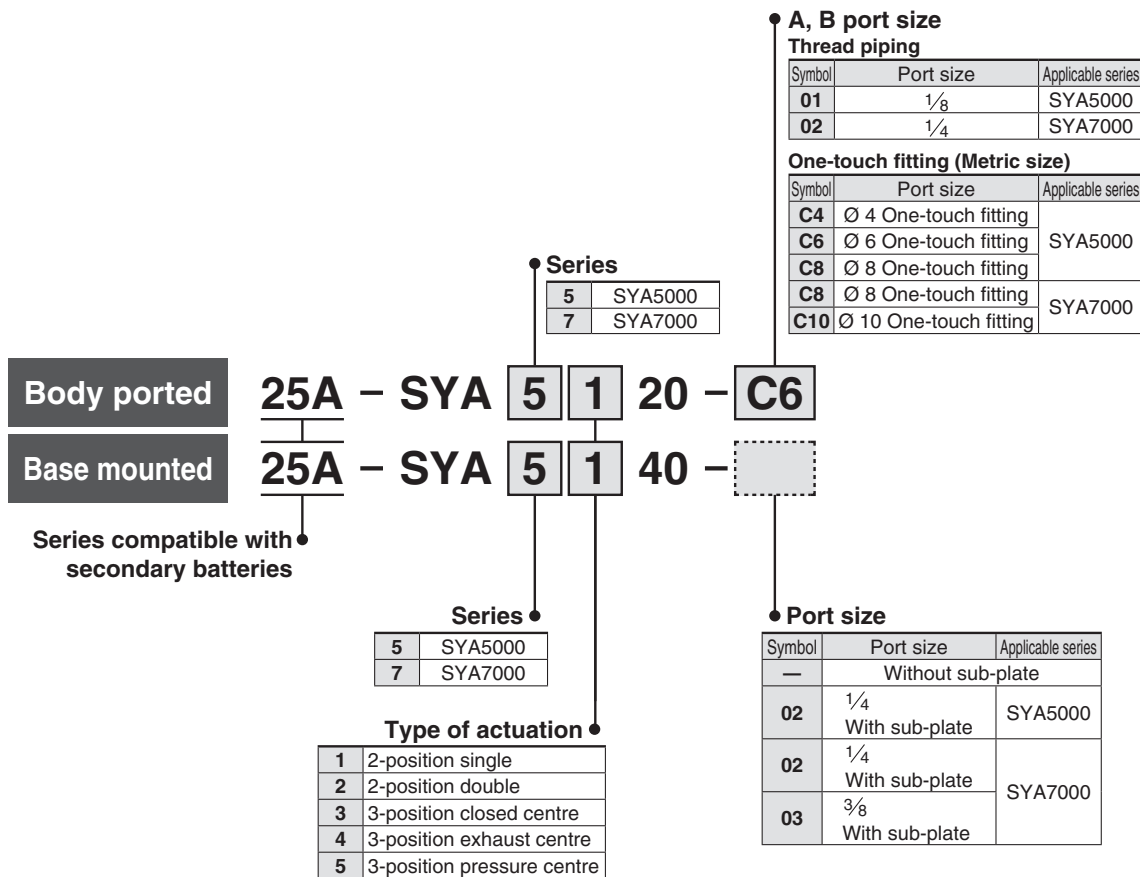

## How to Order Manifold Base

Same manifolds as the SY series (Non plug-in type) are prepared.  
(For 20, 41 and 42 Types)

25A-SS5YA<sup>5</sup><sub>7</sub>- [ ] Fill the same as 25A-SS5Y<sup>5</sup><sub>7</sub>.

(Refer to page 40.)

\* Specify the part numbers for valves and options together beneath the manifold base part number.

<Example>

25A-SS5YA5-42-03-02....1 set (Type 42, 3 station manifold base part no.)

\* 25A-SYA5140 ..... 1 set (Single air operated valve part no.)

\* 25A-SYA5240 ..... 1 set (Double air operated valve part no.)

\* 25A-SY5000-26-1A ..... 1 set (Blanking plate assembly part no.)

↳The asterisk denotes the symbol for assembly.

Prefix it to the part nos. of the solenoid valve, etc.

\* When single body ported air operated valves are ordered, manifold mounting screws and gaskets are not included. Order them separately if necessary.

(For details, refer to page 42.)

\* The 25A- series specifications and dimensions are the same as those of the standard model.

# 3-Port Air Operated Valve

# 25A-SYJA500/700 Series

RoHS



## How to Order

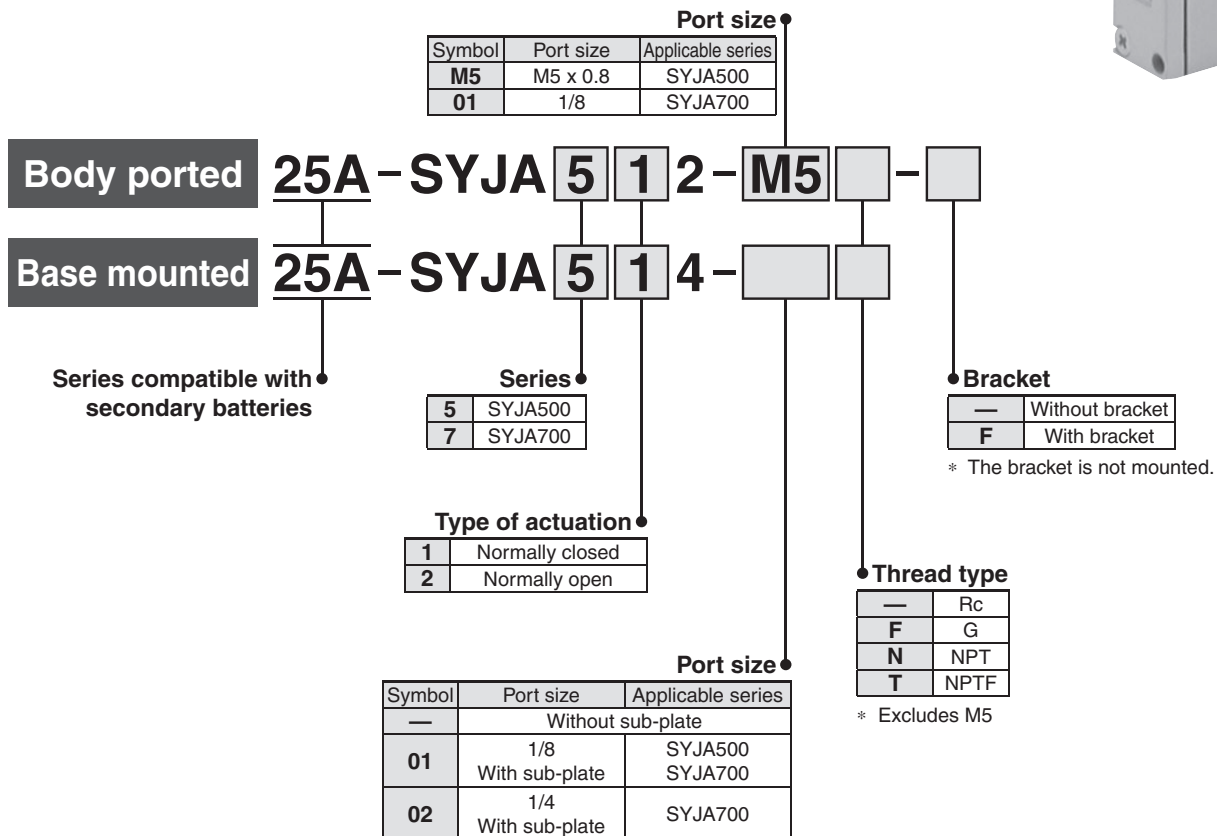

\* The 25A- series specifications and dimensions are the same as those of the standard model.

# 25A-SYJA500/700 Series

## Manifold Type for the SYJA500

### Type 20

How to Order

25A - SS3YJA5 - 20 - 05

Stations

02	2 stations
:	:
20	20 stations

Applicable valve  
25A-SYJA5□2

Applicable blanking  
plate assembly  
25A-SYJ500-10-1A

\* For more than 6 stations, supply air to both sides of P port and exhaust air from both sides of R port.

### Type 40

How to Order

25A - SS3YJA5 - 40 - 05 M5

Stations

02	2 stations
:	:
20	20 stations

A port size

M5	M5 x 0.8
01	1/8

Applicable valve  
25A-SYJA5□4

Applicable blanking  
plate assembly  
25A-SYJ500-10-3A

\* For more than 9 stations, supply air to both sides of P port and exhaust air from both sides of R port.

### Type 41

How to Order

25A - SS3YJA5 - 41 - 05 - C6

Stations

02	2 stations
:	:
20	20 stations

A port size

M5	M5 x 0.8
01	1/8
C4	∅ 4 One-touch fitting
C6	∅ 6 One-touch fitting

Applicable valve  
25A-SYJA5□4

Applicable blanking  
plate assembly  
25A-SYJ500-10-3A

\* For more than 9 stations, supply air to both sides of P port and exhaust air from both sides of R port.

## Manifold Type for the SYJA700

### Type 20/21

How to Order

25A - SS3YJA7 - 20 - 05

Manifold type

20	Type 20
21	Type 21

Stations

02	2 stations
:	:
20	20 stations

Applicable valve  
25A-SYJA7□2

Applicable blanking  
plate assembly  
25A-SYJ700-10-1A

\* If there are more than 6 stations for type 20, or more than 9 stations for type 21, supply air to both sides of P port and exhaust air from both sides of R port.

### Type 40/41

How to Order

25A - SS3YJA7 - 40 - 05 - 01

Manifold type

40	Type 40
41	Type 41

A port size

01	1/8
----	-----

Stations

02	2 stations
:	:
20	20 stations

Applicable valve  
25A-SYJA7□4

Applicable blanking  
plate assembly  
25A-SYJ700-10-2A

\* If there are more than 6 stations for type 40, or more than 9 stations for type 41, supply air to both sides of P port and exhaust air from both sides of R port.

### Type 42

How to Order

25A - SS3YJA7 - 42 - 05 - C6

Stations

02	2 stations
:	:
20	20 stations

A port size

01	1/8
C6	∅ 6 One-touch fitting
C8	∅ 8 One-touch fitting

Applicable valve  
25A-SYJA7□4

Applicable blanking  
plate assembly  
25A-SYJ700-10-2A

\* For more than 9 stations, supply air to both sides of P port and exhaust air from both sides of R port.

# Finger Valve

RoHS

# 25A-VHK□A Series

## How to Order

Series compatible with secondary batteries

25A-VHK **2** A - **04F** - **04F** □ □

### Valve model

2	2-port valve
3	3-port valve

### 1(P) port size

04F	∅ 4
06F	∅ 6
08F	∅ 8
01S	R 1/8
02S	R 1/4
03S	R 3/8

### Bracket

—	None
L	With L-bracket

\* Bracket and screws are attached.

### Knob colour

— (Standard)	2-port valve	Grey
	3-port valve	Blue
R (Option)	2-port valve	Red
	3-port valve	

### 2(A) port size

04F	∅ 4
06F	∅ 6
08F	∅ 8
01S	R 1/8
02S	R 1/4
03S	R 3/8

## Standard Type

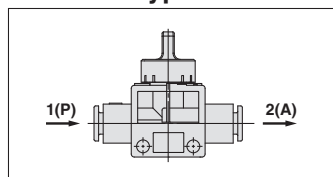

1(P): One-touch fitting  
2(A): One-touch fitting

		2(A) Applicable tubing O.D. [mm]		
		∅ 4	∅ 6	∅ 8
Applicable tubing O.D. [mm]	∅ 4	●		
	∅ 6	●	●	
	∅ 8		●	●

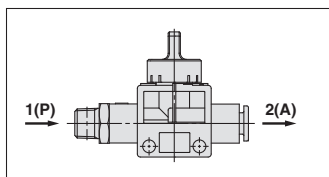

1(P): Male thread  
2(A): One-touch fitting

		2(A) Applicable tubing O.D. [mm]		
		∅ 4	∅ 6	∅ 8
Port size R	1/8	●	●	●
	1/4		●	●
	3/8		●	●

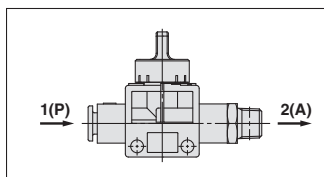

1(P): One-touch fitting  
2(A): Male thread

		2(A) Port size R		
		1/8	1/4	3/8
Applicable tubing O.D. [mm]	∅ 4	●		
	∅ 6	●	●	●
	∅ 8	●	●	●

\* The 25A- series specifications and dimensions are the same as those of the standard model.



# Finger Valve

# 25A-VHK Series



## How to Order

Series compatible with secondary batteries

25A-VHK **2** - **04F** - **04F**      

Valve model

2	2-port valve
3	3-port valve

1(P) port size

04F	Ø 4
06F	Ø 6
08F	Ø 8
01S	R 1/8
02S	R 1/4
03S	R 3/8

Bracket

—	None
L	With L-bracket

\* Bracket and screws are attached.

Knob colour

— (Standard)	2-port valve	Grey
	3-port valve	Blue
R (Option)	2-port valve	Red
	3-port valve	

2(A) port size

04F	Ø 4
06F	Ø 6
08F	Ø 8
01S	R 1/8
02S	R 1/4
03S	R 3/8

## Standard Type

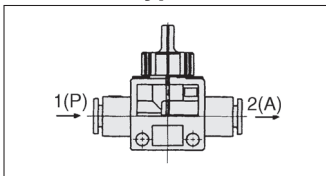

1(P): One-touch fitting  
2(A): One-touch fitting

		2(A)	Applicable tubing O.D. [mm]		
		1(P)	Ø 4	Ø 6	Ø 8
Applicable tubing O.D. [mm]	Ø 4	●			
	Ø 6	●	●		
	Ø 8		●	●	

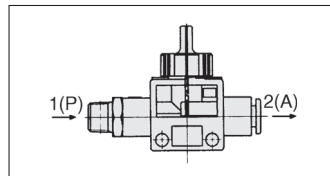

1(P): Male thread  
2(A): One-touch fitting

		2(A)	Applicable tubing O.D. [mm]		
		1(P)	Ø 4	Ø 6	Ø 8
Port size R	1/8	●	●	●	
	1/4		●	●	
	3/8		●	●	

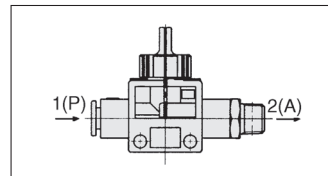

1(P): One-touch fitting  
2(A): Male thread

		2(A)	Port size R		
		1(P)	1/8	1/4	3/8
Applicable tubing O.D. [mm]	Ø 4	●			
	Ø 6	●	●	●	
	Ø 8	●	●	●	

\* The 25A- series specifications and dimensions are the same as those of the standard model.

# Conforming to OSHA Standard

## Pressure Relief 3-Port Valve with Locking Holes (Single Action)

# 25A-VHS20/30/40/50 Series

RoHS

### How to Order

**Single action** 25A - VHS 40 - [ ] 04 A - B - [ ] - [ ]

Series compatible with secondary batteries

Pressure relief 3-port valve

Body size

Symbol	Body size
20	20
30	30
40	40
50	50

Thread type

Symbol	Thread type
—	Rc
N	NPT
F	G

Port size

Symbol	Port size	Body size			
		20	30	40	50
01	1/8	●	—	—	—
02	1/4	●	●	●	—
03	3/8	—	●	●	—
04	1/2	—	—	●	—
06	3/4	—	—	●	●
10	1	—	—	—	●

Handle/Bonnet material

Symbol	Material
A	Flame-resistant PBT
B	Aluminium

Made to order

Symbol	Description
X1	Body: Red

Semi-standard specifications

Symbol	Description
—	—
K	Handle colour: Black
R	Flow direction: Right → Left
Z*1	psi as unit displayed on label

Options

Symbol	Description
—	—
B	With bracket

### Option Part Nos.

Model	Bracket assembly part no.*1
25A-VHS20	VHS20PW-180AS-6
25A-VHS30	VHS30PW-180AS-6
25A-VHS40	VHS40PW-180AS-6
25A-VHS40-06	VHS40PW-180-06AS-6
25A-VHS50	VHS50PW-180AS-6

\*1 Bracket/1 pc., Mounting screw/2 pcs.

### OSHA standard (Occupational Safety and Health Administration Department of Labor)

For safety control, OSHA rule requires energy sources for certain equipment be turned off or disconnected and that the device either be locked or labelled with a warning tag.

\* The 25A- series specifications and dimensions are the same as those of the standard model.

# OSHA Standard Compliant Pressure Relief 3-Port Valve with Locking Holes

Single Action

## 25A-VHS20/30/40/50-D Series

RoHS

Double Action

## 25A-VHS20W/30W/40W/50W-D Series

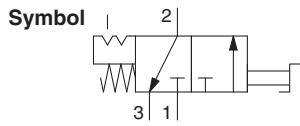

### How to Order

**25A-VHS** 30   -   03 -   -   - **D**

1  
 2  
 3  
 4  
 5  
 6

• Series compatible with secondary batteries

· Option/Semi-standard: Select one each for a to f.  
 · Option/Semi-standard symbol:  
 When more than one specification is required, indicate in alphanumeric order.  
 Example) 25A-VHS30-N03-BS-RZ-D

	Symbol	Description	1				
			Body size				
			20	30	40	50	
2	—	Single action	●	●	●	●	
	W	Double action	●	●	●	●	
3	—	Rc*1	●	●	●	●	
	N	NPT	●	●	●	●	
	F	G	●	●	●	●	
4	01	1/8	●	—	—	—	
	02	1/4	●	●	●	—	
	03	3/8	—	●	●	—	
	04	1/2	—	—	●	—	
	06	3/4	—	—	●	●	
	10	1	—	—	—	●	
5	a	—	Without mounting option	●	●	●	●
		B	With bracket	●	●	●	●
5	b	—	Without silencer	●	●	●	●
		S	With built-in silencer (for EXH port)	●	●	●	●
6	c	—	Red	●	●	●	●
		K	Black	●	●	●	●
6	d	—	Resin	●	●	●	●
		M	Metal	●	●	●	●
6	e	—	Flow direction: Left to right	●	●	●	●
		R	Flow direction: Right to left	●	●	●	●
6	f	—	Product label in SI units: MPa	●	●	●	●
		Z*2	Product label in imperial units: psi	○*3	○*3	○*3	○*3

\*1 The pipe thread type for the EXH port is G.

\*2 For the pipe thread type: NPT only. This product is for overseas use only according to the New Measurement Act.  
 (The SI unit type is provided for use in Japan.)

\*3 ○: For the pipe thread type: NPT only

\* The 25A- series specifications and dimensions are the same as those of the standard model.

### Option/Part Nos.

Optional specifications	Model				
	25A-VHS20-D	25A-VHS30-D	25A-VHS40-D	25A-VHS40-06-D	25A-VHS50-D
Bracket assembly*1	25A-VHS24P-180AS	25A-VHS34P-180AS	25A-VHS44P-180AS	25A-VHS44P-180AS	25A-VHS54P-180AS
Silencer assembly*2	VHS24P-190AS	VHS34P-190AS	VHS44P-190AS	VHS54P-190AS	VHS54P-190AS

\*1 The assembly consists of a bracket A/B and 2 mounting screws.

\*2 The assembly consists of the element assembly and an O-ring.

# Conforming to OSHA Standard

## Pressure Relief 3-Port Valve with Locking Holes (Double Action)

# 25A-VHS2510/3510/4510/5510 Series

RoHS

### How to Order

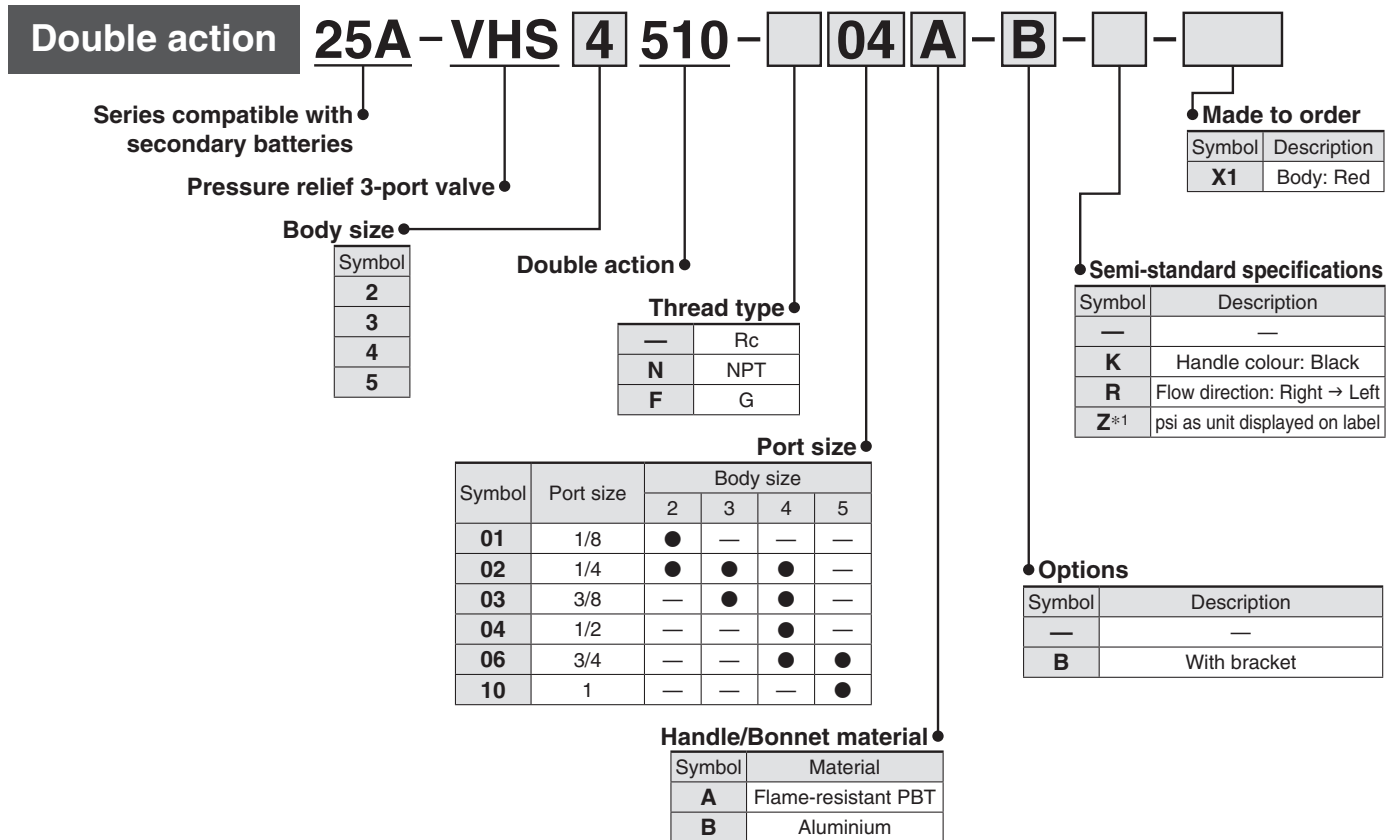

### Option Part Nos.

Model	Bracket assembly part no.*1
25A-VHS2510	VHS20PW-180AS-6
25A-VHS3510	VHS30PW-180AS-6
25A-VHS4510	VHS40PW-180AS-6
25A-VHS4510-06	VHS40PW-180-06AS-6
25A-VHS5510	VHS50PW-180AS-6

\*1 Bracket/1 pc., Mounting screw/2 pcs.

### OSHA standard (Occupational Safety and Health Administration Department of Labor)

For safety control, OSHA rule requires energy sources for certain equipment be turned off or disconnected and that the device either be locked or labelled with a warning tag.

\* The 25A- series specifications and dimensions are the same as those of the standard model.

# Pin Cylinder: Double Acting, Single Rod

# 25A-CJP2 Series

∅ 4, ∅ 6, ∅ 10, ∅ 16

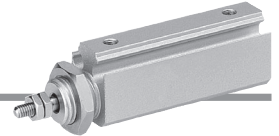

## How to Order

**25A - CDJP2 F 10 - 15 D - [ ] - M9BW S**

Series compatible with secondary batteries

With auto switch (Built-in magnet)

Mounting

Symbol	Mounting	Standard	Built-in magnet
B	Basic	●	●
F	Flange	●	●
L	Foot	●	●
D	Clevis	●	●
T	Trunnion	●	●

- \* Bore size of 4 mm is available with basic mounting only.
- \* Mounting bracket is shipped together (but not assembled).
- \* Trunnion mounting type is shipped after assembled.

Bore size

4	4 mm
6	6 mm
10	10 mm
16	16 mm

Number of auto switches

—	2 pcs.
S	1 pc.

Auto switch

—	Without auto switch
---	---------------------

\* Refer to page 205 for the applicable auto switch model.

Rod end thread

—	With thread
B	Without thread

Double acting

Cylinder standard stroke

Bore size [mm]	Stroke [mm]
4	5, 10, 15, 20*1
6	5, 10, 15, 20, 25
10, 16	5, 10, 15, 20, 25, 30, 35, 40

\*1 20 stroke of bore size 4 mm is standard type only.

### Built-in Magnet Cylinder Model

If a built-in magnet cylinder without an auto switch is required, there is no need to enter the symbol for the auto switch.  
(Example) 25A-CDJP2F10-15D

\* The 25A- series specifications and dimensions are the same as those of the standard model.

### Mounting Bracket Part Nos. for the 25A- Series

Bore size [mm]	Flange	Foot	Trunnion
6	25A-CP-F006A	25A-CP-L006A	25A-CP-T006A
10	25A-CP-F010A	25A-CP-L010A	25A-CP-T010A
16	25A-CP-F016A	25A-CP-L016A	25A-CP-T016A

### Accessory Bracket Part Nos. for the 25A- Series

Bore size [mm]	Single knuckle joint	Double knuckle joint	Knuckle joint pin	Trunnion pin	Mounting nut	Rod end nut
4	—	—	—	—	25A-SNPS-004	25A-NTJ-004
6	25A-I-P006A	25A-Y-P006A	25A-IY-P006	25A-CT-P006	25A-SNP-006	25A-NTP-006
10	25A-I-P010A	25A-Y-P010A	25A-IY-P010	25A-CT-P010	25A-SNP-010	25A-NTP-010
16	25A-I-P016A	25A-Y-P016A	25A-IY-P016	25A-CT-P016	25A-SNP-016	25A-NTP-016

# Air Cylinder: Standard Type Double Acting, Single Rod

## 25A-CJ2 Series

∅ 10, ∅ 16

RoHS



### How to Order

25A-C D J2 L 16 - 60 A Z - M9BW - B

Series compatible with secondary batteries

#### With auto switch

—	Without magnet for switch*1
D	With auto switch (Built-in magnet)

\*1 In the case of without magnet for switch, auto switch cannot be mounted.

#### Mounting

B	Basic
E	Double-side bossed
D	Double clevis
L	Single foot
M	Double foot
F	Rod flange
G	Head flange

\* Mounting bracket is shipped together with the product, but not assembled.

#### Bore size

10	10 mm
16	16 mm

#### Cylinder standard stroke [mm]

10	15, 30, 45, 60, 75, 100, 125, 150
16	15, 30, 45, 60, 75, 100, 125, 150, 175, 200

\* Manufacture of intermediate strokes in 1 mm increments is possible. (Spacers are not used.)

#### Auto switch mounting type

B	Band mounting
---	---------------

\* Refer to page 212 for auto switch mounting brackets.

#### Number of auto switches



—	2
S	1
n	n

#### Auto switch

—	Without auto switch
---	---------------------

\* Refer to page 205 for the applicable auto switch model.  
\* Enter the auto switch mounting type (B) even when a built-in magnet cylinder without an auto switch is required.

#### Head cover port location

Bore size [mm]	∅ 10, ∅ 16	
Symbol	—	Perpendicular to axis 
	R	Axial 

\* Double clevis is only available for being perpendicular to axis.

\* Double-side bossed type is only available for being perpendicular to axis.

#### Cushion

—	Rubber bumper
A	Air cushion

### Mounting Bracket Part Nos. for the 25A- Series

Mounting bracket	Bore size [mm]	
	10	16
Foot bracket	25A-CJ-L010B	CJ-L016SUS
Flange bracket	25A-CJ-F010B	CJ-F016SUS

\* The 25A- series specifications and dimensions are the same as those of the standard model.



# Air Cylinder: Non-rotating Rod Type Double Acting, Single Rod

# 25A-CJ2K Series

∅ 10, ∅ 16



## How to Order

**25A-C** **D** **J2K** **L** **16** - **60** **Z** - **M9BW** **B**

Series compatible with secondary batteries

### With auto switch

—	Without magnet for switch*1
<b>D</b>	With auto switch (Built-in magnet)

\*1 In the case of without magnet for switch, auto switch cannot be mounted.

### Mounting

<b>B</b>	Basic
<b>E</b>	Double-side bossed
<b>D</b>	Double clevis
<b>L</b>	Single foot
<b>M</b>	Double foot
<b>F</b>	Rod flange
<b>G</b>	Head flange

\* Mounting bracket is shipped together with the product, but not assembled.

### Bore size

<b>10</b>	10 mm
<b>16</b>	16 mm

### Cylinder standard stroke [mm]

<b>10</b>	15, 30, 45, 60, 75, 100, 125, 150
<b>16</b>	15, 30, 45, 60, 75, 100, 125, 150, 175, 200

\* Manufacture of intermediate strokes in 1 mm increments is possible. (Spacers are not used.)

### Auto switch mounting type

<b>B</b>	Band mounting
----------	---------------

\* Refer to [page 212](#) for auto switch mounting brackets.

### Number of auto switches

—	2
<b>S</b>	1
<b>n</b>	n



### Auto switch

—	Without auto switch
---	---------------------

\* Refer to [page 205](#) for the applicable auto switch model.

\* Enter the auto switch mounting type (B) even when a built-in magnet cylinder without an auto switch is required.

### Head cover port location

Bore size [mm]	∅ 10, ∅ 16	
Symbol	—	Perpendicular to axis 
	<b>R</b>	Axial 

\* Double clevis is only available for being perpendicular to axis.

\* Double-side bossed type is only available for being perpendicular to axis.

### Mounting Bracket Part Nos. for the 25A- Series

Mounting bracket	Bore size [mm]	
	10	16
Foot bracket	CJ-L016SUS	CJK-L016SUS
Flange bracket	CJ-F016SUS	CJK-F016SUS

\* The 25A- series specifications and dimensions are the same as those of the standard model. (Excluding the foot and flange plate thickness)

# Air Cylinder: With End Lock

## 25A-CBJ2 Series

∅ 16



### How to Order

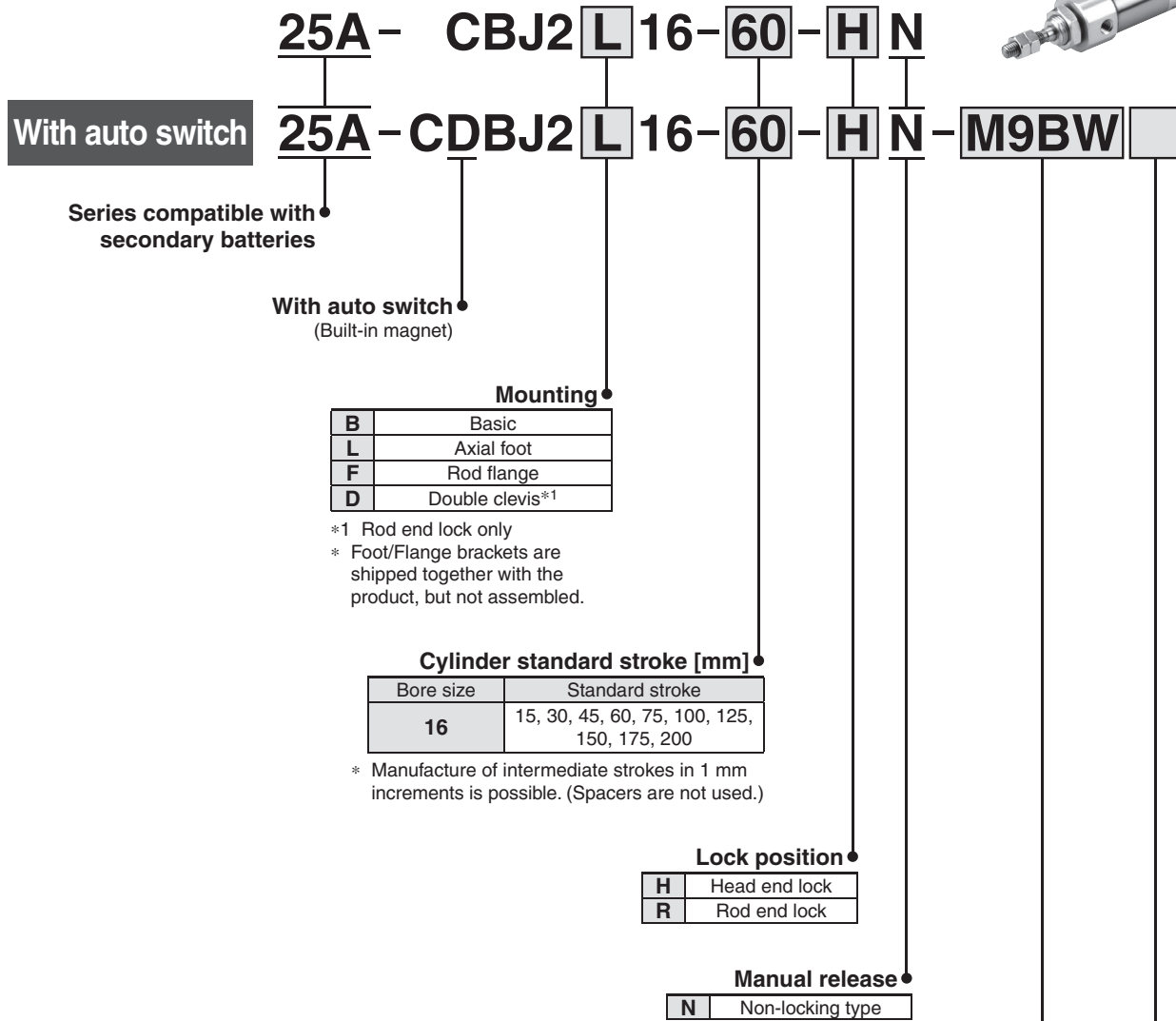

### How to order built-in magnet type (Without auto switch)

Suffix the symbol “-B” (Band mounting) to the end of part number for cylinder with auto switch.

Example	25A-CDBJ2B16-60-HN-B
---------	----------------------

### Mounting Bracket Part Nos. for the 25A- Series

Mounting bracket	Bore size [mm]
	<b>16</b>
Foot bracket	CJ-L016SUS
Flange bracket	CJ-F016SUS

\* The 25A- series specifications and dimensions are the same as those of the standard model.

# Air Cylinder: Standard Type Double Acting, Single Rod

RoHS

# 25A-CM2 Series

∅ 20, ∅ 25, ∅ 32, ∅ 40



## How to Order

**25A-C D M2 L 40 - 150 A Z-M9BW**

Series compatible with secondary batteries

With auto switch

—	Without magnet for switch*1
D	With auto switch (Built-in magnet)

\*1 In the case of without magnet for switch, auto switch cannot be mounted.

Mounting

B	Basic
L	Axial foot
F	Rod flange
G	Head flange
C	Single clevis
D	Double clevis
U	Rod trunnion
T	Head trunnion
E	Integrated clevis
V	Integrated clevis (90°)
BZ	Boss-cut/Basic
FZ	Boss-cut/Rod flange
UZ	Boss-cut/Rod trunnion

Bore size

20	20 mm
25	25 mm
32	32 mm
40	40 mm

Port thread type

—	Rc
TN	NPT
TF	G

Number of auto switches

—	2
S	1
n	n

Auto switch

—	Without auto switch
---	---------------------

\* Refer to page 205 for the applicable auto switch model.

Rod end thread

—	Male rod end
F	Female rod end

Cushion

—	Rubber bumper
A	Air cushion

Cylinder Stroke [mm]

Bore size	Standard stroke*1	Maximum stroke
20		1000
25	25, 50, 75, 100, 125, 150	1500
32	200, 250, 300	2000
40		2000

\*1 Other intermediate strokes can be manufactured upon receipt of order. Manufacture of intermediate strokes in 1 mm increments is possible. (Spacers are not used.)

\* When exceeding 300 strokes, the allowable maximum stroke length is determined by the stroke selection table (Catalogue at [www.smc.eu](http://www.smc.eu) or Best Pneumatics).

## Built-in Magnet Cylinder Model

If a built-in magnet cylinder without an auto switch is required, there is no need to enter the symbol for the auto switch.

(Example) 25A-CDM2F32-100AZ

\* The 25A- series specifications and dimensions are the same as those of the standard model.

## Mounting Bracket Part Nos. for the 25A- Series

Mounting bracket	Min. order	Bore size [mm]				Description (for min. order)
		20	25	32	40	
Axial foot*1	2	CM-L020B-XB12	CM-L032B-XB12	CM-L040B-XB12		2 feet, 1 mounting nut
Flange	1	CM-F020BSUS	CM-F032BSUS	CM-F040BSUS		1 flange
Single clevis*2	1	CM-C020B	CM-C032B	CM-C040B		1 single clevis, 3 liners
Double clevis*2*3 (with pin)	1	25A-CM-D020B	25A-CM-D032B	25A-CM-D040B		1 double clevis, 3 liners, 1 clevis pin, 2 retaining rings
Trunnion (with nut)	1	25-CM-T020B	25-CM-T032B	25-CM-T040B		1 trunnion, 1 trunnion nut

\*1 Order 2 foot brackets for each cylinder unit.

\*2 3 liners are attached with a clevis bracket for adjusting the mounting angle.

\*3 A clevis pin and retaining rings (split pins for ∅ 40) are attached.

# Air Cylinder: Standard Type Double Acting, Single Rod

RoHS

# 25A-CG1 Series

Ø 20, Ø 25, Ø 32, Ø 40, Ø 50, Ø 63, Ø 80, Ø 100



## How to Order

**25A-C D G1 L N 25 - 100 Z-M9BW**

Series compatible with secondary batteries

With auto switch

—	Without magnet for switch*1
D	With auto switch (Built-in magnet)

\*1 In the case of without magnet for switch, auto switch cannot be mounted.

Mounting

B	Basic
Z*1	Basic (without trunnion mounting female thread)
L	Axial foot
F	Rod flange
G	Head flange
U*1	Rod trunnion
T*1	Head trunnion
D	Clevis

\*1 Not available for Ø 80 or Ø 100.

\* Mounting bracket is shipped together with the product, but not assembled.

\* The cylinder for F, G, L, D mounting types is Z: Basic (without trunnion mounting female thread).

Type

N	Rubber bumper
A	Air cushion

Bore size

20	20 mm
25	25 mm
32	32 mm
40	40 mm
50	50 mm
63	63 mm
80	80 mm
100	100 mm

### Built-in Magnet Cylinder Model

If a built-in magnet cylinder without an auto switch is required, there is no need to enter the symbol for the auto switch.

(Example) 25A-CDG1FN32-100Z

Number of auto switches

—	2
S	1
n	n

Auto switch

—	Without auto switch
---	---------------------

\* Refer to page 205 for the applicable auto switch model.

Rod end thread

—	Rod end male thread
F	Rod end female thread

Cylinder stroke [mm]

Bore size [mm]	Standard stroke*1 [mm]	Long stroke*2 [mm]
20	25, 50, 75, 100, 125, 150, 200	201 to 1500
25	25, 50, 75, 100, 125, 150, 200, 250, 300	301 to 1500
32		
40		
50, 63		
80		
100		

\*1 Other intermediate strokes can be manufactured upon receipt of order. Manufacture of intermediate strokes in 1 mm increments is possible. (Spacers are not used.)

\*2 The long stroke shows the maximum manufacturable stroke. For details about maximum stroke that can be used for each mounting bracket, refer to the stroke selection table (Catalogue at [www.smc.eu](http://www.smc.eu) or Best Pneumatics).

Port thread type

Rubber bumper

—	Rc	Ø 20 to Ø 100
TN	NPT	Ø 20 to Ø 100
TF	M5 x 0.8	Ø 20, Ø 25
	G	Ø 32 to Ø 100

Air cushion

M5 x 0.8	Ø 20, Ø 25
Rc	Ø 32 to Ø 100
NPT*1	Ø 32 to Ø 100
G*1	Ø 32 to Ø 100

\*1 Not available for Ø 20 and Ø 25.

\* The 25A- series specifications and dimensions are the same as those of the standard model.

### Mounting Bracket Part Nos. for the 25A- Series

Mounting bracket	Min. order	Bore size [mm]								Description (for min. order)
		20	25	32	40	50	63	80	100	
Foot	2*1	90-CG-L020	90-CG-L025	90-CG-L032	90-CG-L040	90-CG-L050	25-CG-L063	25-CG-L080	25-CG-L100	Foot x 2, Mounting bolt x 8
Flange	1	90-CG-F020	90-CG-F025	90-CG-F032	90-CG-F040	90-CG-F050	25-CG-F063	25-CG-F080	25-CG-F100	Flange x 1, Mounting bolt x 4
Trunnion pin	1	25-CG-T020	25-CG-T025	25-CG-T032	25-CG-T040	25-CG-T050	25-CG-T063	—	—	Trunnion pin x 2, Trunnion bolt x 2, Flat washer x 2
Clevis	1	25-CG-D020	25-CG-D025	25-CG-D032	25-CG-D040	25-CG-D050	25-CG-D063	25-CG-D080	25-CG-D100	Clevis x 1, Mounting bolt x 4, Clevis pin x 1, Retaining ring x 2
Pivot bracket	1	25-CG-020-24A	25-CG-025-24A	25-CG-032-24A	25-CG-040-24A	25-CG-050-24A	25-CG-063-24A	25-CG-080-24A	25-CG-100-24A	Pivot bracket x 1

\*1 Order two foot brackets per cylinder.

# Air Cylinder: With End Lock



# 25A-CBG1 Series

∅ 20, ∅ 25, ∅ 32, ∅ 40, ∅ 50, ∅ 63

## How to Order



**25A - CBG1 L N 25 - 100 - H N**

**25A - CDBG1 L N 25 - 100 - H N - M9BW**

Series compatible with secondary batteries

With auto switch (Built-in magnet)

Number of auto switches

—	2
S	1
n	n

Mounting

B	Basic
L	Axial foot
F	Rod flange
G	Head flange
U	Rod trunnion
T	Head trunnion
D	Clevis

\* Mounting brackets are shipped together, but not assembled.

Auto switch

—	Without auto switch
---	---------------------

\* For applicable auto switches, refer to page 205.

Manual release

N	Non-locking type
---	------------------

Lock position

H	Head end lock
R	Rod end lock
W	Double end lock

Type

N	Rubber bumper
---	---------------

Bore size

20	20 mm
25	25 mm
32	32 mm
40	40 mm
50	50 mm
63	63 mm

Cylinder stroke [mm]

Bore size	Standard stroke*1	Long stroke*2
20	25, 50, 75, 100, 125, 150, 200	201 to 1500
25	25, 50, 75, 100, 125, 150, 200, 250, 300	301 to 1500
32		
40		
50, 63		

\*1 Other intermediate strokes can be manufactured upon receipt of order. Manufacture of intermediate strokes in 1 mm increments is possible. (Spacers are not used.)

\*2 The long stroke shows the maximum manufacturable stroke. For details about maximum stroke that can be used for each mounting bracket, refer to the stroke selection table (Catalogue at [www.smc.eu](http://www.smc.eu) or Best Pneumatics).

### Built-in Magnet Cylinder Model

If a built-in magnet cylinder without an auto switch is required, there is no need to enter the symbol for the auto switch.

(Example) 25A-CDBG1FN32-100-RN

### Mounting Bracket Part Nos. for the 25A- Series

Mounting bracket	Min. order	Bore size [mm]						Description (for min. order)
		20	25	32	40	50	63	
Foot	2*1	90-CG-L020	90-CG-L025	90-CG-L032	90-CG-L040	90-CG-L050	25-CG-L063	Foot x 2, Mounting bolt x 8
Flange	1	90-CG-F020	90-CG-F025	90-CG-F032	90-CG-F040	90-CG-F050	25-CG-F063	Flange x 1, Mounting bolt x 4
Trunnion pin	1	25-CG-T020	25-CG-T025	25-CG-T032	25-CG-T040	25-CG-T050	25-CG-T063	Trunnion pin x 2, Trunnion bolt x 2, Flat washer x 2
Clevis	1	25-CG-D020	25-CG-D025	25-CG-D032	25-CG-D040	25-CG-D050	25-CG-D063	Clevis x 1, Mounting bolt x 4, Clevis pin x 1, Retaining ring x 2
Pivot bracket	1	25-CG-020-24A	25-CG-025-24A	25-CG-032-24A	25-CG-040-24A	25-CG-050-24A	25-CG-063-24A	Pivot bracket x 1

\*1 Order two foot brackets per cylinder.

\* The 25A- series specifications and dimensions are the same as those of the standard model.

# Air Cylinder: Single Rod



# 25A-MB Series

∅ 32, ∅ 40, ∅ 50, ∅ 63, ∅ 80, ∅ 100

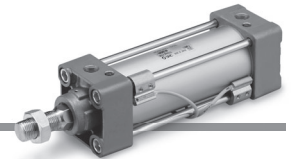

## How to Order

**25A-M D B L 32-50 Z-M9BW**

Series compatible with secondary batteries

With auto switch

—	Without magnet for switch*1
D	With auto switch (Built-in magnet)

\*1 In the case of without magnet for switch, auto switch cannot be mounted.

Number of auto switches

—	2
S	1
3	3
n	n

Auto switch

—	Without auto switch
---	---------------------

\* Refer to page 205 for the applicable auto switch model.

Mounting

B	Basic
L	Axial foot
F	Rod flange
G	Head flange
C	Single clevis
D	Double clevis
T	Centre trunnion

Cylinder stroke [mm]

Bore [mm]	Standard stroke [mm]
32	25, 50, 75, 100, 125, 150, 175, 200, 250, 300, 350, 400, 450, 500
40	25, 50, 75, 100, 125, 150, 175, 200, 250, 300, 350, 400, 450, 500
50	25, 50, 75, 100, 125, 150, 175, 200, 250, 300, 350, 400, 450, 500, 600
63	25, 50, 75, 100, 125, 150, 175, 200, 250, 300, 350, 400, 450, 500, 600
80	25, 50, 75, 100, 125, 150, 175, 200, 250, 300, 350, 400, 450, 500, 600, 700, 800
100	25, 50, 75, 100, 125, 150, 175, 200, 250, 300, 350, 400, 450, 500, 600, 700, 800

\* Intermediate strokes are available. (No spacer is used.)

Bore size

32	32 mm
40	40 mm
50	50 mm
63	63 mm
80	80 mm
100	100 mm

## Built-in Magnet Cylinder Model

If a built-in magnet cylinder without an auto switch is required, there is no need to enter the symbol for the auto switch.

(Example) 25A-MDBB40-100Z

\* The 25A- series specifications and dimensions are the same as those of the standard model.

## Mounting Bracket Part Nos. for the 25A- Series

Bore size [mm]	32	40	50	63	80	100
Foot*1	25-MB-L03	25-MB-L04	25-MB-L05	25-MB-L06	25-MB-L08	25-MB-L10
Flange	MB-F03-XC7	MB-F04-XC7	MB-F05-XC7	MB-F06-XC7	MB-F08-XC7	MB-F10-XC7
Single clevis	25-MB-C03	25-MB-C04	25-MB-C05	25-MB-C06	25-MB-C08	25-MB-C10
Double clevis	25-MB-D03	25-MB-D04	25-MB-D05	25-MB-D06	25-MB-D08	25-MB-D10

\*1 Two foot brackets required for one cylinder.

\* Accessories for each mounting bracket are as follows: Foot, flange, single clevis/body mounting bolt, double clevis/body mounting bolt, clevis pin, flat washers and split pins.



# Air Cylinder: Standard Type Double Acting, Single Rod

# 25A-CA2 Series

∅ 40, ∅ 50, ∅ 63, ∅ 80, ∅ 100



## How to Order

**25A-C D A2 L 50-100 Z-M9BW**

Series compatible with secondary batteries

**With auto switch**

—	Without magnet for switch*1
D	With auto switch (Built-in magnet)

\*1 In the case of without magnet for switch, auto switch cannot be mounted.

**Mounting**

B	Basic
L	Axial foot
F	Rod flange
G	Head flange
C	Single clevis
D	Double clevis
T	Centre trunnion

**Bore size**

40	40 mm
50	50 mm
63	63 mm
80	80 mm
100	100 mm

**Number of auto switches**

—	2
S	1
3	3
n	n

**Auto switch**

—	Without auto switch
---	---------------------

\* Refer to page 205 for the applicable auto switch model.

**Cylinder stroke [mm]**

40	25, 50, 75, 100, 125, 150, 175, 200, 250, 300, 350, 400, 450, 500
50, 63	25, 50, 75, 100, 125, 150, 175, 200, 250, 300, 350, 400, 500, 600
80, 100	25, 50, 75, 100, 125, 150, 175, 200, 250, 300, 350, 400, 450, 500, 600, 700

\* Intermediate strokes not listed above are produced upon receipt of order.

### Built-in Magnet Cylinder Model

If a built-in magnet cylinder without an auto switch is required, there is no need to enter the symbol for the auto switch (Example) 25A-CDA2L40-100Z

\* The 25A- series specifications and dimensions are the same as those of the standard model.

### Mounting Bracket Part Nos. for the 25A- Series

Bore size [mm]	40	50	63	80	100
Axial foot*1	90-CA2-L04	90-CA2-L05	90-CA2-L06	90-CA2-L08	90-CA2-L10
Flange	25A-CA2-F04	25A-CA2-F05	25A-CA2-F06	25A-CA2-F08	25A-CA2-F10
Single clevis	25A-CA2-C04	25A-CA2-C05	25A-CA2-C06	25A-CA2-C08	25A-CA2-C10
Double clevis*2	25A-CA2-D04	25A-CA2-D05	25A-CA2-D06	25A-CA2-D08	25A-CA2-D10

\*1 When axial foot brackets are used, two pieces should be ordered for each cylinder.

\*2 A clevis pin, flat washers and split pins are shipped together with double clevis.

# Air Cylinder: Standard Type Double Acting, Single Rod

# 25A-CS2 Series

∅ 125, ∅ 140, ∅ 160

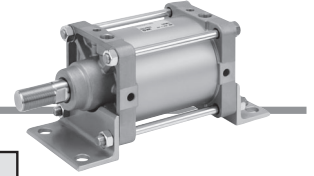

## How to Order

**25A-C** **D** **S2** **L** **125** **□** - **300** - **M9BW** **□**

Series compatible with secondary batteries

With auto switch

—	Without magnet for switch*1
<b>D</b>	With auto switch (Built-in magnet)

\*1 In the case of without magnet for switch, auto switch cannot be mounted.

Mounting

<b>B</b>	Basic
<b>L</b>	Foot
<b>F</b>	Rod flange
<b>G</b>	Head flange
<b>C</b>	Single clevis
<b>D</b>	Double clevis
<b>T</b>	Centre trunnion

Bore size

<b>125</b>	125 mm
<b>140</b>	140 mm
<b>160</b>	160 mm

Number of auto switches

—	2
<b>3</b>	3
<b>S</b>	1
<b>n</b>	n

Auto switch

—	Without auto switch
---	---------------------

\* Refer to page 205 for the applicable auto switch model.

Cylinder stroke [mm]

Mounting bracket	Maximum stroke	
	Basic, Head flange, Single clevis, Double clevis, Centre trunnion	Foot, Rod flange
Bore size		
<b>125</b>	1000 or less	1600 or less
<b>140</b>		
<b>160</b>	1200 or less	

Port thread type

—	Rc
<b>TN</b>	NPT
<b>TF</b>	G

### Built-in Magnet Cylinder Model

If a built-in magnet cylinder without auto switch is required, there is no need to enter the symbol for auto switch.

(Example) 25A-CS2B125-100

\* The 25A- series specifications and dimensions are the same as those of the standard model.

### Mounting Bracket Part Nos. for the 25A- Series

Bore size [mm]	125	140	160
Axial foot*1	CS2-L12	CS2-L14	CS2-L16
Flange	CS2-F12	CS2-F14	CS2-F16
Single clevis	CS2-C12	CS2-C14	CS2-C16
Double clevis*2	25A-CS2-D12	25A-CS2-D14	25A-CS2-D16

\*1 Order two foot brackets per cylinder.

\*2 A clevis pin and split pins are shipped together with double clevis.

# Mini Free Mount Cylinder

## 25A-CUJ Series

∅ 6, ∅ 8, ∅ 10



### How to Order

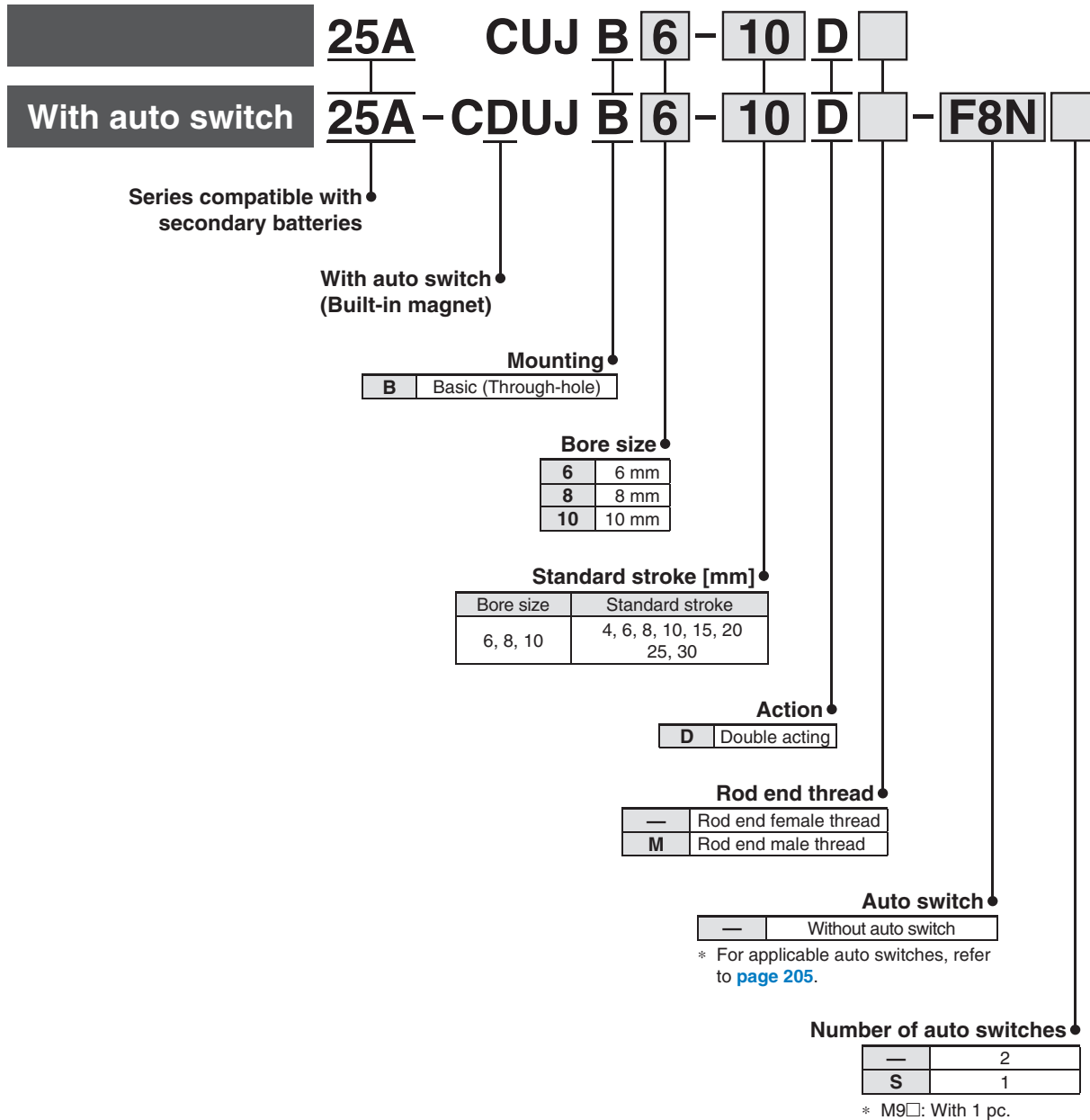
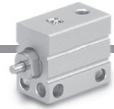

### Built-in Magnet Cylinder Model

If a built-in magnet cylinder without an auto switch is required, there is no need to enter the symbol for the auto switch.  
(Example) 25A-CDUJB8-15DM

\* The 25A- series specifications are the same as those of the standard model.

## Dimensions (Dimensions other than those shown below are the same as the standard product.)

25A-C□UJB <sup>6</sup>/<sub>8</sub>/<sub>10</sub>

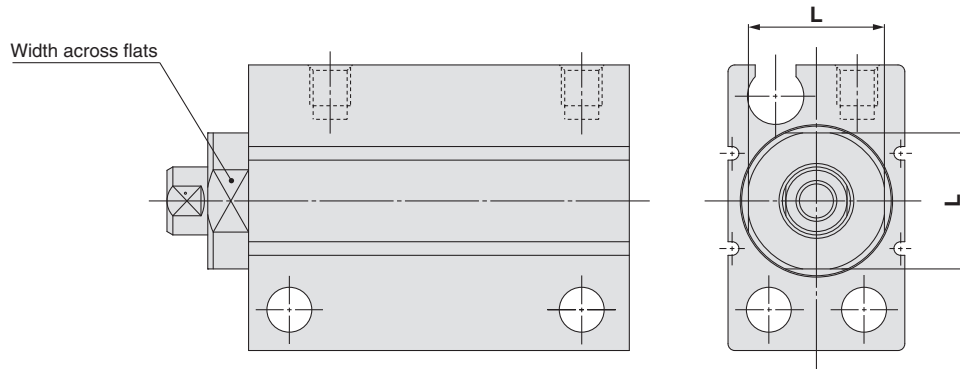

[mm]	
Bore size	L dimension
6	8
8	10
10	11

# Mini Free Mount Cylinder

## 25A-CUJ Series

∅ 12, ∅ 16, ∅ 20

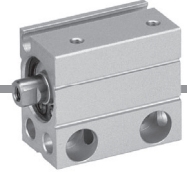

### How to Order

**25A - CUJ B 12 - 30 D**

**With auto switch 25A - CDUJ B 12 - 30 D - F8N**

Series compatible with secondary batteries

With auto switch (Built-in magnet)

**Mounting direction**

**B** Lateral mounting

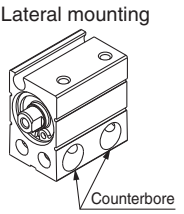

**S** Axial mounting

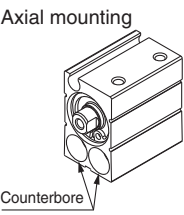

**Bore size**

12	12 mm
16	16 mm
20	20 mm

**Standard stroke [mm]**

Bore size	Standard stroke
12, 16, 20	5, 10, 15, 20, 25 30, 35, 40, 45, 50

**Action**

D	Double acting
---	---------------

**Rod end thread**

—	Rod end female thread
M	Rod end male thread

**Auto switch**

—	Without auto switch
---	---------------------

\* For applicable auto switches, refer to [page 205](#).

**Number of auto switches**

—	2
S	1

\* M9□: With 1 pc.

### Built-in Magnet Cylinder Model

If a built-in magnet cylinder without an auto switch is required, there is no need to enter the symbol for the auto switch.  
(Example) 25A-CDUJB12-15DM

\* The 25A- series specifications and dimensions are the same as those of the standard model.

# Free Mount Cylinder Double Acting, Single Rod **25A-CU Series** ∅ 10, ∅ 16, ∅ 20, ∅ 25, ∅ 32

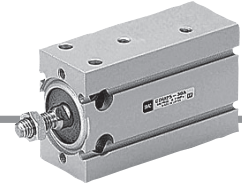

## How to Order

**25A - C D U 16 - 30 D - M9BW** [ ]

Series compatible with secondary batteries

With auto switch

—	Without magnet for switch*1
<b>D</b>	With auto switch (Built-in magnet)

\*1 In the case of without magnet for switch, auto switch cannot be mounted.

Bore size

<b>10</b>	10 mm
<b>16</b>	16 mm
<b>20</b>	20 mm
<b>25</b>	25 mm
<b>32</b>	32 mm

Number of auto switches

—	2
<b>S</b>	1

Auto switch

— Without auto switch

\* Refer to page 205 for applicable auto switches.

Action

**D** Double acting

Cylinder stroke [mm]

Bore size	Standard stroke	Long stroke
<b>10, 16</b>	5, 10, 15, 20, 25, 30	40, 50, 60
<b>20, 25, 32</b>	5, 10, 15, 20, 25, 30, 40, 50	60, 70, 80, 90, 100

### Built-in Magnet Cylinder Model

If a built-in magnet cylinder without an auto switch is required, there is no need to enter the symbol for the auto switch.  
(Example) 25A-CDU20-25D

\* The 25A- series specifications and dimensions are the same as those of the standard model.



# Free Mount Cylinder: Non-rotating Rod Type Double Acting, Single Rod

## 25A-CUK Series

∅ 10, ∅ 16, ∅ 20, ∅ 25, ∅ 32

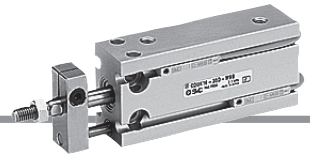

### How to Order

25A - C D UK 16 - 30 D - M9BW

Series compatible with secondary batteries

With auto switch

—	Without magnet for switch*1
D	With auto switch (Built-in magnet)

\*1 In the case of without magnet for switch, auto switch cannot be mounted.

Non-rotating rod type

Bore size

10	10 mm
16	16 mm
20	20 mm
25	25 mm
32	32 mm

Number of auto switches

—	2
S	1

Auto switch

—	Without auto switch
---	---------------------

\* Refer to page 205 for applicable auto switches.

Action

D	Double acting
---	---------------

Cylinder stroke [mm]

Bore size	Standard stroke	Long stroke
10, 16	5, 10, 15, 20, 25, 30	40, 50, 60
20, 25, 32	5, 10, 15, 20, 25, 30, 40, 50	60, 70, 80, 90, 100

### Built-in Magnet Cylinder Model

If a built-in magnet cylinder without an auto switch is required, there is no need to enter the symbol for the auto switch.

(Example) 25A-CDUK20-25D

\* The 25A- series specifications and dimensions are the same as those of the standard model.

# Compact Cylinder: Standard Type Double Acting, Single Rod

# 25A-CQS Series

∅ 12, ∅ 16, ∅ 20, ∅ 25

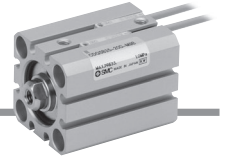

## How to Order

**25A-C D QS B 20-30 D - M9BW**

Series compatible with secondary batteries

With auto switch

—	Without magnet for switch*1
D	With auto switch (Built-in magnet)

\*1 In the case of without magnet for switch, auto switch cannot be mounted.

Mounting

B	Through-hole/Both ends tapped common (Standard)
L	Foot
F	Rod flange
G	Head flange
D	Double clevis

\* In the case of long strokes, use either ends tapped mounting or bracket mounting.  
\* Mounting brackets are shipped together, but not assembled.  
\* Cylinder mounting bolts are not included.

Bore size

12	12 mm
16	16 mm
20	20 mm
25	25 mm

Number of auto switches

—	2
S	1
n	n

Auto switch

—	Without auto switch
---	---------------------

\* Refer to page 205 for the applicable auto switch model.

Body option

<Standard stroke>

—	Standard
C	With rubber bumper
M	Rod end male thread

\* Combination of body options is available.

<Long stroke>

C	With rubber bumper Rod end female thread (Standard)
CM	With rubber bumper Rod end male thread

\* Rubber bumper is standard equipment for long stroke type.

Action

D	Double acting
---	---------------

Cylinder stroke [mm]

Bore size	Standard stroke	Long stroke
12, 16	5, 10, 15, 20, 25, 30	35, 40, 45, 50, 75, 100, 125, 150, 175, 200
20	5, 10, 15, 20, 25, 30, 35, 40, 45, 50	75, 100, 125, 150, 175, 200
25		75, 100, 125, 150, 175, 200, 250, 300

## Built-in Magnet Cylinder Model

If a built-in magnet cylinder without an auto switch is required, there is no need to enter the symbol for the auto switch.  
(Example) 25A-CDQSL25-30D

\* The 25A- series specifications and dimensions are the same as those of the standard model.

## Mounting Bracket Part Nos. for the 25A- Series

Bore size [mm]	Foot*1	Flange	Double clevis
12	25A-CQS-L012	25A-CQS-F012	25-CQS-D012
16	25A-CQS-L016	25A-CQS-F016	25-CQS-D016
20	25A-CQS-L020	25A-CQS-F020	25-CQS-D020
25	25A-CQS-L025	25A-CQS-F025	25-CQS-D025

\*1 When ordering foot bracket, order 2 pieces per cylinder.

\* Parts belonging to each bracket are as follows.

Foot or Flange type: Body mounting bolt

Double clevis type: Clevis pin, Type C retaining ring for axis, Body mounting bolt.

# Compact Cylinder: Standard Type Double Acting, Double Rod

RoHS

# 25A-CQSW Series

∅ 12, ∅ 16, ∅ 20, ∅ 25



## How to Order

**25A-C D QSW B 20-30 D - M9BWL**

**Series compatible with secondary batteries**

**With auto switch**

—	Without magnet for switch*1
D	With auto switch (Built-in magnet)

\*1 In the case of without magnet for switch, auto switch cannot be mounted.

**Mounting**

B	Through-hole/Both ends tapped common (Standard)
L	Foot
F	Flange

\* Mounting brackets are shipped together, but not assembled.  
\* Cylinder mounting bolts are not included.

**Bore size**

12	12 mm
16	16 mm
20	20 mm
25	25 mm

**Number of auto switches**

—	2
S	1
n	n

**Auto switch**

—	Without auto switch
---	---------------------

\* For applicable auto switches, refer to [page 205](#).

**Cushion/Rod end thread**

—	Standard
C	With rubber bumper
M	Rod end male thread

\* Combination of body options is available.

**Action**

D	Double acting
---	---------------

**Cylinder stroke [mm]**

Bore size	Standard stroke
12, 16	5, 10, 15, 20, 25, 30
20	5, 10, 15, 20, 25, 30, 35, 40, 45, 50
25	30, 35, 40, 45, 50

## Mounting Bracket Part Nos. for the 25A- Series

Bore size [mm]	Foot*1	Flange
12	25A-CQS-L012	25A-CQS-F012
16	25A-CQS-L016	25A-CQS-F016
20	25A-CQS-L020	25A-CQS-F020
25	25A-CQS-L025	25A-CQS-F025

- \*1 When ordering foot brackets, order 2 pieces per cylinder.  
\* Body mounting bolts are included for each bracket.

## Built-in Magnet Cylinder Model

If a built-in magnet cylinder without an auto switch is required, there is no need to enter the symbol for the auto switch.

(Example) 25A-CDQSWL25-30D

- \* The 25A- series specifications and dimensions are the same as those of the standard model.

# Compact Cylinder: Anti-lateral Load Type

# 25A-CQS□S Series

∅ 12, ∅ 16, ∅ 20, ∅ 25

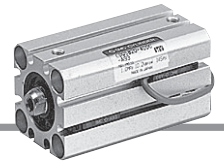

## How to Order

25A-C □ D Q S B S 20 - 30 D C - M9BW □

Series compatible with secondary batteries

With auto switch

—	Without magnet for switch*1
D	With auto switch (Built-in magnet)

\*1 In the case of without magnet for switch, auto switch cannot be mounted.

Mounting

B	Through-hole/Both ends tapped common (Standard)
L	Foot
F	Rod flange
G	Head flange
D	Double clevis

\* Mounting brackets are shipped together, but not assembled.  
\* Cylinder mounting bolts are not included.

Cushion

S	Anti-lateral load type
---	------------------------

Bore size

12	12 mm
16	16 mm
20	20 mm
25	25 mm

Cylinder stroke [mm]

Bore size	Standard stroke
12, 16	5, 10, 15, 20, 25, 30
20, 25	5, 10, 15, 20, 25, 30, 35, 40, 45, 50

Number of auto switches

—	2
S	1
n	n

Auto switch

—	Without auto switch
---	---------------------

\* Refer to page 205 for the applicable auto switch model.

Body option

C	With rubber bumper Rod end female thread (Standard)
CM	With rubber bumper Rod end male thread

Action

D	Double acting
---	---------------

### Built-in Magnet Cylinder Model

If a built-in magnet cylinder without an auto switch is required, there is no need to enter the symbol for the auto switch.

(Example) 25A-CDQSLS12-25DC

\* With cushion only.

\* The 25A- series specifications and dimensions are the same as those of the standard model.

### Mounting Bracket Part Nos. for the 25A- Series

Bore size [mm]	Foot*1	Flange	Double clevis
12	25A-CQS-L012	25A-CQS-F012	25-CQS-D012
16	25A-CQS-L016	25A-CQS-F016	25-CQS-D016
20	25A-CQS-L020	25A-CQS-F020	25-CQS-D020
25	25A-CQS-L025	25A-CQS-F025	25-CQS-D025

\*1 When ordering foot bracket, order 2 pieces per cylinder.

\* Parts belonging to each bracket are as follows.

Foot or Flange type: Body mounting bolt

Double clevis type: Clevis pin, Type C retaining ring for axis, Body mounting bolt

# Compact Cylinder: Standard Double Acting, Single Rod



# 25A-CQ2 Series

Ø 12, Ø 16, Ø 20, Ø 25, Ø 32, Ø 40, Ø 50, Ø 63, Ø 80, Ø 100

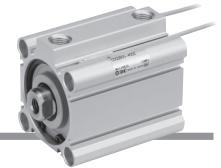

## How to Order

**25A - C D Q2 B 20 - 30 D Z - M9BW**

• Series compatible with secondary batteries

With auto switch

—	Without magnet for switch*1
D	With auto switch (Built-in magnet)

\*1 In the case of without magnet for switch, auto switch cannot be mounted.

Mounting

B	Through-hole (Standard)
A	Both ends tapped
L	Foot
F	Rod flange
G	Head flange
D	Double clevis

\* Mounting brackets are shipped together, but not assembled.  
\* Cylinder mounting bolts are not included.

Bore size

12	12 mm	40	40 mm
16	16 mm	50	50 mm
20	20 mm	63	63 mm
25	25 mm	80	80 mm
32	32 mm	100	100 mm

Port thread type

—	M thread	Ø 12 to Ø 25
	Rc	
TN	NPT	Ø 32 to Ø 100
TF	G	

• Auto switch

— Without auto switch

\* Refer to page 205 for the applicable auto switch model.

• Number of auto switches

—	2
S	1
n	n

• Auto switch mounting groove

Z	Ø 12 to Ø 25	2 surfaces
	Ø 32 to Ø 100	4 surfaces

\* "Z" is not available for Ø 12 to Ø 25 without auto switches.

• Body option

—	Standard (Rod end female thread)
C	With rubber bumper
M	Rod end male thread

\* Combination of body options is available.

• Action

D Double acting

• Cylinder stroke [mm]

12, 16	5, 10, 15, 20, 25, 30
20, 25	5, 10, 15, 20, 25, 30, 35, 40, 45, 50
32, 40	5, 10, 15, 20, 25, 30, 35, 40, 45, 50, 75, 100
50 to 100	10, 15, 20, 25, 30, 35, 40, 45, 50, 75, 100

\* The 25A-series specifications and dimensions are the same as those of the standard model.

## Built-in Magnet Cylinder Model

If a built-in magnet cylinder without an auto switch is required, there is no need to enter the symbol for the auto switch. (Example) 25A-CDQ2L32-25DZ

## Mounting Bracket Part Nos. for the 25A-Series (Without auto switch)

Bore size [mm]	Foot*1	Flange	Double clevis
12	25A-CQ-L012	25A-CQ-F012	25-CQ-D012
16	25A-CQ-L016	25A-CQ-F016	25-CQ-D016
20	25A-CQ-L020	25A-CQ-F020	25-CQ-D020
25	25A-CQ-L025	25A-CQ-F025	25-CQ-D025
32	25A-CQ-L032	25A-CQ-F032	25-CQ-D032
40	25A-CQ-L040	25A-CQ-F040	25-CQ-D040
50	25A-CQ-L050	25A-CQ-F050	25-CQ-D050
63	25A-CQ-L063	25A-CQ-F063	25-CQ-D063
80	25A-CQ-L080	25A-CQ-F080	25-CQ-D080
100	25A-CQ-L100	25A-CQ-F100	25-CQ-D100

\*1 When ordering a foot bracket, the required quantity will be different depending on the bore size.

Ø 12 to Ø 25:

• Without switch: Order 2 pieces per cylinder.

• With switch: Order 1 piece per cylinder. (Part number for a set of 2 foot brackets)

Ø 32 to Ø 100:

• Order 2 pieces per cylinder.

\* Parts belonging to each bracket are as follows.

Foot or Flange: Body mounting bolts, Double clevis: Clevis pin, Type C retaining rings for axis, Body mounting bolts

## Mounting Bracket Part Nos. for the 25A-Series (With auto switch)

Bore size [mm]	Foot*1	Flange	Double clevis
12	25A-CQ-LZ12	25A-CQ-F012	25-CQ-D012
16	25A-CQ-LZ16	25A-CQ-F016	25-CQ-D016
20	25A-CQ-LZ20	25A-CQ-F020	25-CQ-D020
25	25A-CQ-LZ25	25A-CQ-F025	25-CQ-D025
32	25A-CQ-L032	25A-CQ-F032	25-CQ-D032
40	25A-CQ-L040	25A-CQ-F040	25-CQ-D040
50	25A-CQ-L050	25A-CQ-F050	25-CQ-D050
63	25A-CQ-L063	25A-CQ-F063	25-CQ-D063
80	25A-CQ-L080	25A-CQ-F080	25-CQ-D080
100	25A-CQ-L100	25A-CQ-F100	25-CQ-D100

## Simple Joint (Standard) Part Nos.

Bore size [mm]	Joint	Type A mounting bracket	Type B mounting bracket
32, 40	YU-03	YA-03	YB-03
50, 63	YU-05	YA-05	YB-05
80	YU-08	YA-08	YB-08
100	YU-10	YA-10	YB-10

<Ordering>

• Joints are not included with type A or B mounting brackets. Order them separately.

(Example)

Bore size Ø 40

Part no.

• Type A mounting bracket .....YA-03

• Joint.....YU-03

# Compact Cylinder: Standard Double Acting, Double Rod

RoHS

# 25A-CQ2W Series

Ø 12, Ø 16, Ø 20, Ø 25, Ø 32, Ø 40, Ø 50, Ø 63, Ø 80, Ø 100

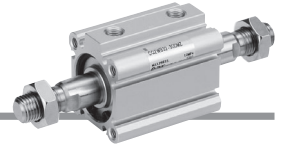

## How to Order

**25A - C D Q2W B 20 - 30 D Z - M9BW**

Series compatible with secondary batteries

With auto switch

—	Without magnet for switch*1
D	With auto switch (Built-in magnet)

\*1 In the case of without magnet for switch, auto switch cannot be mounted.

Mounting

\* Mounting brackets are shipped together, but not assembled.  
\* Cylinder mounting bolts are not included.

B	Through-hole (Standard)
A	Both ends tapped
L	Foot
F	Flange

Bore size

12	12 mm	40	40 mm
16	16 mm	50	50 mm
20	20 mm	63	63 mm
25	25 mm	80	80 mm
32	32 mm	100	100 mm

### Mounting Bracket Part Nos. for the 25A- Series (Without auto switch)

Bore size [mm]	Foot*1	Flange
12	25A-CQ-L012	25A-CQ-F012
16	25A-CQ-L016	25A-CQ-F016
20	25A-CQ-L020	25A-CQ-F020
25	25A-CQ-L025	25A-CQ-F025
32	25A-CQ-L032	25A-CQ-F032
40	25A-CQ-L040	25A-CQ-F040
50	25A-CQ-L050	25A-CQ-F050
63	25A-CQ-L063	25A-CQ-F063
80	25A-CQ-L080	25A-CQ-F080
100	25A-CQ-L100	25A-CQ-F100

### Mounting Bracket Part Nos. for the 25A- Series (With auto switch)

Bore size [mm]	Foot*1	Flange
12	25A-CQ-LZ12	25A-CQ-F012
16	25A-CQ-LZ16	25A-CQ-F016
20	25A-CQ-LZ20	25A-CQ-F020
25	25A-CQ-LZ25	25A-CQ-F025
32	25A-CQ-L032	25A-CQ-F032
40	25A-CQ-L040	25A-CQ-F040
50	25A-CQ-L050	25A-CQ-F050
63	25A-CQ-L063	25A-CQ-F063
80	25A-CQ-L080	25A-CQ-F080
100	25A-CQ-L100	25A-CQ-F100

\*1 When ordering a foot bracket, the required quantity will be different depending on the bore size.  
Ø 12 to Ø 25:  
· Without switch: Order 2 pieces per cylinder.  
· With switch: Order 1 piece per cylinder. (Part number for a set of 2 foot brackets)  
Ø 32 to Ø 100:  
· Order 2 pieces per cylinder.  
\* Body mounting bolts are included for each bracket.

Number of auto switches

—	2
S	1
n	n

Auto switch

—	Without auto switch
---	---------------------

\* For applicable auto switches, refer to page 205.

Auto switch mounting groove

Z	Ø 12 to Ø 25	2 surfaces
	Ø 32 to Ø 100	4 surfaces

\* "Z" is not available for Ø 12 to Ø 25 without auto switches.

Body option

—	Standard (Rod end female thread)
C	With rubber bumper
M	Rod end male thread

\* Combination of body options is available.

Action

D	Double acting
---	---------------

Cylinder stroke [mm]

12, 16	5, 10, 15, 20, 25, 30
20, 25	5, 10, 15, 20, 25, 30, 35, 40, 45, 50
32, 40	5, 10, 15, 20, 25, 30, 35, 40, 45, 50, 75, 100
50 to 100	10, 15, 20, 25, 30, 35, 40, 45, 50, 75, 100

Port thread type

—	M thread	Ø 12 to Ø 25
	Rc	
TN	NPT	Ø 32 to Ø 100
TF	G	

### Built-in Magnet Cylinder Model

If a built-in magnet cylinder without an auto switch is required, there is no need to enter the symbol for the auto switch.

(Example) 25A-CDQ2WL32-25DZ

\* The 25A- series specifications and dimensions are the same as those of the standard model.

### Simple Joint (Standard)/Part Nos.

Bore size [mm]	Joint	Type A mounting bracket	Type B mounting bracket
32, 40	YU-03	YA-03	YB-03
50, 63	YU-05	YA-05	YB-05
80	YU-08	YA-08	YB-08
100	YU-10	YA-10	YB-10

<Ordering>

Joints are not included with type A or B mounting brackets. Order them separately.

(Example)

Bore size Ø 40  
Type A mounting bracket ..... **YA-03**  
Joint ..... **YU-03**

# Compact Cylinder: Large Bore Size Double Acting, Single Rod

RoHS

## 25A-CQ2 Series

∅ 125, ∅ 140, ∅ 160, ∅ 180, ∅ 200



### How to Order

**25A-C D Q2B 125 - 30 DC Z - M9BW**

- Series compatible with secondary batteries**
- With auto switch**

—	Without magnet for switch*1
D	With auto switch (Built-in magnet)

\*1 In the case of without magnet for switch, auto switch cannot be mounted.
- Mounting**

B	Through-hole/ Both ends tapped common (Standard)
---	---

\* Cylinder mounting bolts are not included.
- Bore size**

125	125 mm
140	140 mm
160	160 mm
180	180 mm
200	200 mm
- Port thread type**

—	Rc
TN	NPT
TF	G
- Number of auto switches**

—	2
S	1
n	n
- Auto switch**

—	Without auto switch
---	---------------------

\* Refer to [page 205](#) for the applicable auto switch model.
- Auto switch mounting groove**

Z	∅ 125 to ∅ 200	4 surfaces
---	----------------	------------
- Body option**

—	Standard (Rod end female thread)
M	Rod end male thread
- Cushion**

C	Rubber bumper
---	---------------
- Action**

D	Double acting
---	---------------
- Cylinder stroke [mm]**

Bore size	Standard stroke
125, 140, 160	10, 20, 30, 40, 50, 75, 100, 125,
180, 200	150, 175, 200, 250, 300

### Built-in Magnet Cylinder Model

If a built-in magnet cylinder without an auto switch is required, there is no need to enter the symbol for the auto switch.

(Example) 25A-CDQ2B140-30DCZ

\* The 25A- series specifications and dimensions are the same as those of the standard model.



# Compact Cylinder: Long Stroke Double Acting, Single Rod



# 25A-CQ2 Series

∅ 32, ∅ 40, ∅ 50, ∅ 63, ∅ 80, ∅ 100



## How to Order

**25A - C D Q2 A 32 - 200 DC Z - M9BW**

- Series compatible with secondary batteries**
- With auto switch**

—	Without magnet for switch*1
D	With auto switch (Built-in magnet)

\*1 In the case of without magnet for switch, auto switch cannot be mounted.
- Mounting**

A	Both ends tapped
L	Foot
F	Rod flange
G	Head flange
D	Double clevis

\* Mounting brackets are shipped together, but not assembled.
- Bore size**

32	32 mm
40	40 mm
50	50 mm
63	63 mm
80	80 mm
100	100 mm
- Port thread type**

—	Rc
TN	NPT
TF	G
- Auto switch**

—	Without auto switch
---	---------------------

\* Refer to page 205 for the applicable auto switch model.
- Auto switch mounting groove**

Z	4 surfaces
---	------------
- Body option**

—	Standard (Rod end female thread)
M	Rod end male thread
- Cushion**

C	Rubber bumper
---	---------------
- Action**

D	Double acting
---	---------------
- Number of auto switches**

—	2
S	1
n	n
- Cylinder stroke [mm]**

Bore size	Standard stroke
32, 40, 50 63, 80, 100	125, 150, 175, 200, 250, 300

### Built-in Magnet Cylinder Model

If a built-in magnet cylinder without an auto switch is required, there is no need to enter the symbol for the auto switch.  
(Example) 25A-CDQ2L40-200DCZ

### Simple Joint (Standard)/Part Nos.

Bore size [mm]	Joint	Type A mounting bracket	Type B mounting bracket
32, 40	YU-03	YA-03	YB-03
50, 63	YU-05	YA-05	YB-05
80	YU-08	YA-08	YB-08
100	YU-10	YA-10	YB-10

<Ordering>

• Joints are not included with type A or B mounting brackets. Order them separately.

(Example)

Bore size ∅ 40

Part no.

• Type A mounting bracket.....YA-03

• Joint.....YU-03

### Mounting Bracket Part Nos. for the 25A- Series

Bore size [mm]	Foot*1	Flange	Double clevis
32	25A-CQ-L032	25A-CQ-F032	25-CQ-D032
40	25A-CQ-L040	25A-CQ-F040	25-CQ-D040
50	25A-CQ-L050	25A-CQ-F050	25-CQ-D050
63	25A-CQ-L063	25A-CQ-F063	25-CQ-D063
80	25A-CQ-L080	25A-CQ-F080	25-CQ-D080
100	25A-CQ-L100	25A-CQ-F100	25-CQ-D100

\*1 Order 2 pieces per cylinder.

\* Parts belonging to each bracket are as follows.

Foot or Flange: Body mounting bolts, Double clevis: Clevis pin, Type C retaining rings for axis, Body mounting bolts

\* The 25A- series specifications and dimensions are the same as those of the standard model.

# Compact Cylinder: Anti-lateral Load

# 25A-CQ2□S Series

∅ 32, ∅ 40, ∅ 50, ∅ 63, ∅ 80, ∅ 100

RoHS

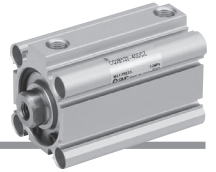

## How to Order

**25A-C D Q2 B S 32 □ - 30 D C □ Z - M9BW □**

- Series compatible with secondary batteries**
- With auto switch**

—	Without magnet for switch*1
D	With auto switch (Built-in magnet)

\*1 In the case of without magnet for switch, auto switch cannot be mounted.
- Mounting**

B	Through-hole (Standard)
A	Both ends tapped
L	Foot
F	Rod flange
G	Head flange
D	Double clevis

\* Mounting brackets are shipped together, but not assembled.  
\* Cylinder mounting bolts are not included.
- Type**

S	Anti-lateral load
---	-------------------
- Bore size**

32	32 mm
40	40 mm
50	50 mm
63	63 mm
80	80 mm
100	100 mm
- Port thread type**

—	Rc
TN	NPT
TF	G
- Number of auto switches**

—	2
S	1
n	n
- Auto switch**

—	Without auto switch
---	---------------------

\* Refer to page 205 for the applicable auto switch model.
- Auto switch mounting groove**

Z	4 surfaces
---	------------
- Body option**

—	Standard (Rod end female thread)
M	Rod end male thread
- Cushion**

C	Rubber bumper
---	---------------
- Action**

D	Double acting
---	---------------
- Cylinder stroke [mm]**

Bore size	Standard stroke
32, 40	5, 10, 15, 20, 25, 30, 35, 40, 45, 50, 75, 100
50, 63, 80, 100	10, 15, 20, 25, 30, 35, 40, 45, 50, 75, 100

### Built-in Magnet Cylinder Model

If a built-in magnet cylinder without an auto switch is required, there is no need to enter the symbol for the auto switch.

(Example) 25A-CDQ2LS40-30DCZ

\* The 25A- series specifications and dimensions are the same as those of the standard model.

### Mounting Bracket Part Nos. for the 25A- Series

Bore size [mm]	Foot*1	Flange	Double clevis
32	25A-CQ-L032	25A-CQ-F032	25-CQ-D032
40	25A-CQ-L040	25A-CQ-F040	25-CQ-D040
50	25A-CQ-L050	25A-CQ-F050	25-CQ-D050
63	25A-CQ-L063	25A-CQ-F063	25-CQ-D063
80	25A-CQ-L080	25A-CQ-F080	25-CQ-D080
100	25A-CQ-L100	25A-CQ-F100	25-CQ-D100

\*1 Order 2 pieces per cylinder.

\* Parts belonging to each bracket are as follows.

Foot or Flange: Body mounting bolts, Double clevis: Clevis pin, Type C retaining rings for axis, Body mounting bolts

# Compact Cylinder: With End Lock

# 25A-CBQ2 Series

Ø 20, Ø 25, Ø 32, Ø 40, Ø 50, Ø 63, Ø 80, Ø 100

RoHS

## How to Order



Without auto switch

25A - CBQ2 B 40 [ ] - 30 DC [ ] - H N

With auto switch

25A - CDBQ2 B 40 [ ] - 30 DC [ ] - H N - M9BW [ ]

Series compatible with secondary batteries

With auto switch (Built-in magnet)

Mounting

Ø 20, Ø 25		Ø 32 to Ø 100	
B	Through-hole/Both ends tapped common (Standard)	B	Through-hole (Standard)*1
L	Foot	A	Both ends tapped
F	Rod flange	L	Foot
G	Head flange	F	Rod flange
D	Double clevis	G	Head flange
		D	Double clevis

\*1 At the 75 and 100 mm strokes with Ø 80, Ø 100, both ends tapped (A) is the standard. Through-hole (B) is not available.  
\* Mounting brackets are shipped together, but not assembled.

Bore size				Port thread type		
20	20 mm	50	50 mm	-	M thread	Ø 20, Ø 25
25	25 mm	63	63 mm		Rc	
32	32 mm	80	80 mm	TN	NPT	Ø 32 to Ø 100
40	40 mm	100	100 mm	TF	G	

Bore size		Standard stroke
20, 25, 32, 40, 50, 63		10, 15, 20, 25, 50, 75, 100
80, 100		25, 50, 75, 100

### Built-in Magnet Cylinder Model

If a built-in magnet cylinder without an auto switch is required, there is no need to enter the symbol for the auto switch.  
(Example) 25A-CDBQ2L32-30DC-RN

### Mounting Bracket Part Nos. for the 25A- Series

Bore size [mm]	Foot*1	Flange	Double clevis
20	25A-CQS-L020	25A-CQS-F020	25-CQS-D020
25	25A-CQS-L025	25A-CQS-F025	25-CQS-D025
32	25A-CQ-L032	25A-CQ-F032	25-CQ-D032
40	25A-CQ-L040	25A-CQ-F040	25-CQ-D040
50	25A-CQ-L050	25A-CQ-F050	25-CQ-D050
63	25A-CQ-L063	25A-CQ-F063	25-CQ-D063
80	25A-CQ-L080	25A-CQ-F080	25-CQ-D080
100	25A-CQ-L100	25A-CQ-F100	25-CQ-D100

\*1 Order 2 pieces per cylinder.

\* Parts belonging to each bracket are as follows: Foot or Flange: Body mounting bolts, Double clevis: Clevis pin, Type C retaining rings for axis, Body mounting bolts

Manual release type

N Non-lock type

Lock position

H Head end lock  
R Rod end lock

Body option

- Rod end female thread  
M Rod end male thread

Cushion

C Rubber bumper

Action

D Double acting

Auto switch

- Without auto switch

\* For applicable auto switches, refer to page 205.

Number of auto switches

-	2
S	1
n	n

\* The 25A- series specifications and dimensions are the same as those of the standard model.

# Mechanically Jointed Rodless Cylinder Basic Type

RoHS

# 25A-MY1B Series

∅ 16, ∅ 20, ∅ 25, ∅ 32, ∅ 40, ∅ 50, ∅ 63



## How to Order

∅ 16, ∅ 20, ∅ 50, ∅ 63

25A-MY1B 20 [ ] [ ] - 300 [ ] - M9BW [ ]

∅ 25, ∅ 32, ∅ 40

25A-MY1B 25 [ ] [ ] - 300 [ ] Z - M9BW [ ]

Series compatible with secondary batteries

Basic type

Bore size

16	16 mm
20	20 mm
25	25 mm
32	32 mm
40	40 mm
50	50 mm
63	63 mm

Number of auto switches

—	2
S	1
n	n

Auto switch

—	Without auto switch (Built-in magnet)
---	---------------------------------------

\* Applicable auto switches vary depending on the bore size. Select an applicable one referring to [page 205](#).

Port thread type

Symbol	Type	Bore size
—	M5	∅ 16, ∅ 20
	Rc	
TN	NPT	∅ 25, ∅ 32, ∅ 40
TF	G	∅ 50, ∅ 63

Piping

—	Standard type
G	Centralised piping type

Cylinder stroke [mm]

Bore size	Standard stroke*	Long stroke	Maximum manufacturable stroke
16	100, 200, 300, 400, 500, 600 700, 800, 900, 1000, 1200 1400, 1600, 1800, 2000	Strokes of 2001 to 3000 mm (1 mm increments) exceeding the standard stroke	3000
20, 25, 32 40, 50, 63	* The stroke can be manufactured in 1 mm increments from 1 mm stroke.	Strokes of 2001 to 5000 mm (1 mm increments) exceeding the standard stroke	5000

Ordering example

\* Long stroke can be ordered the same as the standard stroke. 25A-MY1B20-3000L-M9BW

\* Please be advised that with a stroke of 49 mm or less, there are cases where auto switch mounting is not possible, and the performance of the air cushion may decline.

For ∅ 16 to ∅ 40

Stroke adjustment unit symbol

		Right side stroke adjustment unit									
		Without unit	A: With adjustment bolt			L: With low load shock absorber + Adjustment bolt			H: With high load shock absorber + Adjustment bolt		
			With short spacer	With long spacer	With short spacer	With long spacer	With short spacer	With long spacer	With short spacer	With long spacer	
Left side stroke adjustment unit	Without unit	—	SA	SA6	SA7	SL	SL6	SL7	SH	SH6	SH7
	A: With adjustment bolt	AS	A	AA6	AA7	AL	AL6	AL7	AH	AH6	AH7
		With short spacer	A6S	A6A	A6	A6A7	A6L	A6L6	A6L7	A6H	A6H6
	With long spacer	A7S	A7A	A7A6	A7	A7L	A7L6	A7L7	A7H	A7H6	A7H7
L: With low load shock absorber + Adjustment bolt	Without unit	LS	LA	LA6	LA7	L	LL6	LL7	LH	LH6	LH7
	With short spacer	L6S	L6A	L6A6	L6A7	L6L	L6	L6L7	L6H	L6H6	L6H7
	With long spacer	L7S	L7A	L7A6	L7A7	L7L	L7L6	L7	L7H	L7H6	L7H7
H: With high load shock absorber + Adjustment bolt	Without unit	HS	HA	HA6	HA7	HL	HL6	HL7	H	HH6	HH7
	With short spacer	H6S	H6A	H6A6	H6A7	H6L	H6L6	H6L7	H6H	H6	H6H7
	With long spacer	H7S	H7A	H7A6	H7A7	H7L	H7L6	H7L7	H7H	H7H6	H7

Stroke adjustment unit mounting diagram

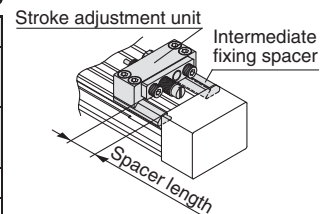

Example of H6H7 attachment

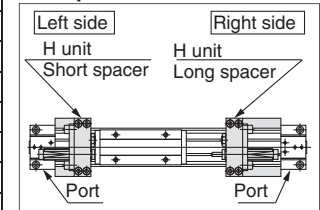

\* Spacers are used to fix the stroke adjustment unit at an intermediate stroke position.

\* The 25A-MY1B50 and 63 are not available with the stroke adjustment unit.

\* The stroke adjustment unit H unit is not available for the 25A-MY1B16.

\* The 25A- series specifications and dimensions are the same as those of the standard model.

# Mechanically Jointed Rodless Cylinder

## Slide Bearing Guide Type

RoHS

# 25A-MY1M Series

∅ 16, ∅ 20, ∅ 25, ∅ 32, ∅ 40, ∅ 50, ∅ 63

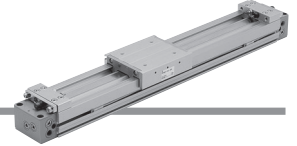

### How to Order

**25A - MY1M** **20** **G** - **300** - **M9BW**

Series compatible with secondary batteries

Slide bearing guide type

Bore size

16	16 mm
20	20 mm
25	25 mm
32	32 mm
40	40 mm
50	50 mm
63	63 mm

Port thread type

Symbol	Type	Bore size
—	M thread	∅ 16, ∅ 20
—	Rc	∅ 25, ∅ 32,
TN	NPT	∅ 40, ∅ 50,
TF	G	∅ 63

Piping

—	Standard type
G	Centralised piping type

Cylinder stroke [mm]

Bore size	Standard stroke*	Long stroke	Maximum manufacturable stroke
16	100, 200, 300, 400, 500, 600, 700, 800, 900, 1000, 1200, 1400, 1600, 1800, 2000	Strokes of 2001 to 3000 mm (1 mm increments) exceeding the standard stroke	3000
20, 25, 32, 40, 50, 63	* The stroke can be manufactured in 1 mm increments from 1 mm stroke.	Strokes of 2001 to 5000 mm (1 mm increments) exceeding the standard stroke	5000

Ordering example

\* Long stroke can be ordered the same as the standard stroke.  
25A-MY1M20-3000L-M9BW

\* Please be advised that with a stroke of 4.9 mm or less, there are cases where auto switch mounting is not possible, and the performance of the air cushion may decline.

Number of auto switches

—	2
S	1
n	n

Auto switch

—	Without auto switch (Built-in magnet)
---	---------------------------------------

\* Refer to page 205 for the applicable auto switch model.

### Stroke adjustment unit symbol

	Right side stroke adjustment unit									
	Without unit	A: With adjustment bolt			L: With low load shock absorber + Adjustment bolt			H: With high load shock absorber + Adjustment bolt		
		With short spacer	With long spacer		With short spacer	With long spacer		With short spacer	With long spacer	
<b>Without unit</b>	—	SA	SA6	SA7	SL	SL6	SL7	SH	SH6	SH7
<b>A: With adjustment bolt</b>	AS	A	AA6	AA7	AL	AL6	AL7	AH	AH6	AH7
With short spacer	A6S	A6A	A6	A6A7	A6L	A6L6	A6L7	A6H	A6H6	A6H7
With long spacer	A7S	A7A	A7A6	A7	A7L	A7L6	A7L7	A7H	A7H6	A7H7
<b>L: With low load shock absorber + Adjustment bolt</b>	LS	LA	LA6	LA7	L	LL6	LL7	LH	LH6	LH7
With short spacer	L6S	L6A	L6A6	L6A7	L6L	L6	L6L7	L6H	L6H6	L6H7
With long spacer	L7S	L7A	L7A6	L7A7	L7L	L7L6	L7	L7H	L7H6	L7H7
<b>H: With high load shock absorber + Adjustment bolt</b>	HS	HA	HA6	HA7	HL	HL6	HL7	H	HH6	HH7
With short spacer	H6S	H6A	H6A6	H6A7	H6L	H6L6	H6L7	H6H	H6	H6H7
With long spacer	H7S	H7A	H7A6	H7A7	H7L	H7L6	H7L7	H7H	H7H6	H7

### Stroke adjustment unit mounting diagram

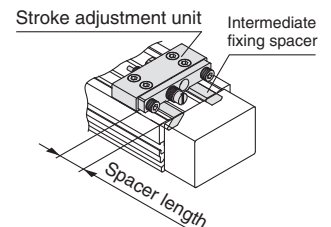

### Example of H6H7 attachment

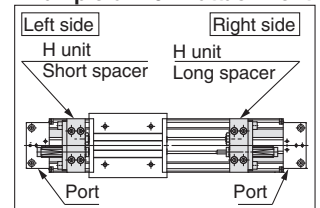

\* Spacers are used to fix the stroke adjustment unit at an intermediate stroke position.  
\* Stroke adjustment unit H is not available for 25A-MY1M16.

\* The 25A- series specifications and dimensions are the same as those of the standard model.

# Mechanically Jointed Rodless Cylinder Cam Follower Guide Type

RoHS

# 25A-MY1C Series

∅ 16, ∅ 20, ∅ 25, ∅ 32, ∅ 40, ∅ 50, ∅ 63



## How to Order

25A - MY1C 25 [ ] [ ] - 300 [ ] - M9BW [ ] - [ ]

Series compatible with secondary batteries

Cam follower guide type

Bore size

16	16 mm
20	20 mm
25	25 mm
32	32 mm
40	40 mm
50	50 mm
63	63 mm

Port thread type

Symbol	Type	Bore size
—	M thread	∅ 16, ∅ 20
	Rc	∅ 25, ∅ 32,
TN	NPT	∅ 40, ∅ 50,
TF	G	∅ 63

Piping

—	Standard type
G	Centralised piping type

Cylinder stroke [mm]

Bore size	Standard stroke*	Long stroke	Maximum manufacturable stroke
16	100, 200, 300, 400, 500, 600 700, 800, 900, 1000, 1200 1400, 1600, 1800, 2000	Strokes of 2001 to 3000 mm (1 mm increments) exceeding the standard stroke	3000
20, 25, 32 40, 50, 63	* The stroke can be manufactured in 1 mm increments from 1 mm stroke.	Strokes of 2001 to 5000 mm (1 mm increments) exceeding the standard stroke	5000

Ordering example

\* Long stroke can be ordered the same as the standard stroke. 25A-MY1C20-3000L-M9BW

\* Please be advised that with a stroke of 49 mm or less, there are cases where auto switch mounting is not possible, and the performance of the air cushion may decline.

Made to order

Symbol	Specifications
-XC56	With knock pin hole

Number of auto switches

—	2
S	1
n	n

Auto switch

—	Without auto switch (Built-in magnet)
---	--

\* Refer to page 205 for the applicable auto switch model.

Stroke adjustment unit symbol

		Right side stroke adjustment unit											
		Without unit	A: With adjustment bolt		L: With low load shock absorber + Adjustment bolt		H: With high load shock absorber + Adjustment bolt						
			With short spacer	With long spacer	With short spacer	With long spacer	With short spacer	With long spacer	With short spacer	With long spacer			
Left side stroke adjustment unit	Without unit	—	SA	SA6	SA7	SL	SL6	SL7	SH	SH6	SH7		
	A: With adjustment bolt	AS	A	AA6	AA7	AL	AL6	AL7	AH	AH6	AH7		
		With short spacer	A6S	A6A	A6	A6A7	A6L	A6L6	A6L7	A6H	A6H6	A6H7	
	With long spacer	A7S	A7A	A7A6	A7	A7L	A7L6	A7L7	A7H	A7H6	A7H7		
	L: With low load shock absorber + Adjustment bolt	LS	LA	LA6	LA7	L	LL6	LL7	LH	LH6	LH7		
		With short spacer	L6S	L6A	L6A6	L6A7	L6L	L6	L6L7	L6H	L6H6	L6H7	
With long spacer	L7S	L7A	L7A6	L7A7	L7L	L7L6	L7	L7H	L7H6	L7H7			
H: With high load shock absorber + Adjustment bolt	HS	HA	HA6	HA7	HL	HL6	HL7	H	HH6	HH7			
	With short spacer	H6S	H6A	H6A6	H6A7	H6L	H6L6	H6L7	H6H	H6	H6H7		
With long spacer	H7S	H7A	H7A6	H7A7	H7L	H7L6	H7L7	H7H	H7H6	H7			

Stroke adjustment unit mounting diagram

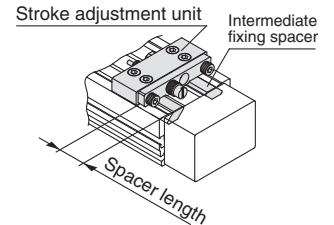

Example of H6H7 attachment

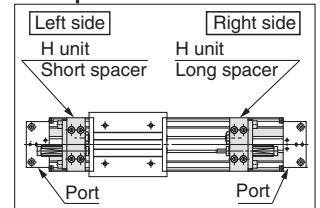

\* Spacers are used to fix the stroke adjustment unit at an intermediate stroke position.

\* Stroke adjustment unit H is not available for 25A-MY1C16.

\* The 25A- series specifications and dimensions are the same as those of the standard model.



# Mechanically Jointed Rodless Cylinder Linear Guide Type

RoHS

# 25A-MY1H Series

∅ 16, ∅ 20, ∅ 25, ∅ 32, ∅ 40

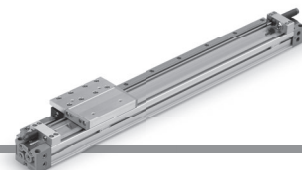

## How to Order

Ordering example: **∅ 16, ∅ 20 25A-MY1H20 [ ] [ ] - 300 [ ] - M9BW [ ]**  
**∅ 25, ∅ 32, ∅ 40 25A-MY1H25 [ ] [ ] - 300 [ ] Z - M9BW [ ]**

Series compatible with secondary batteries: **25A**  
 Linear guide type: **MY1H**  
 Bore size: **20** (or **25**)  
 Port thread type: **[ ]**  
 Piping: **[ ]**  
 Cylinder stroke [mm]: **300**  
 Auto switch: **M9BW** (Number of auto switches: **2**)

16	16 mm
20	20 mm
25	25 mm
32	32 mm
40	40 mm

Symbol	Type	Bore size
—	M thread	∅ 16, ∅ 20
	Rc	
TN	NPT	∅ 25, ∅ 32,
TF	G	∅ 40

—	Standard type
G	Centralised piping type

Bore size	Standard stroke	Intermediate stroke	Long stroke	Maximum manufacturable stroke
16, 20	50, 100, 150 200, 250, 300	Strokes of 51 to 599 mm (1 mm increments) other than standard strokes	Strokes of 601 to 1000 mm (1 mm increments) exceeding the standard stroke	1000
25, 32, 40	350, 400, 450 500, 550, 600		Strokes of 601 to 1500 mm (1 mm increments) exceeding the standard stroke	1500

—	Without auto switch (Built-in magnet)
S	1
n	n

\* Refer to page 205 for the applicable auto switch model.

Ordering example

\* Intermediate stroke can be ordered the same as the standard stroke. 25A-MY1H20-60-M9BW

\* Long stroke can be ordered the same as the standard stroke. 25A-MY1H20-800L-M9BW

## Stroke adjustment unit symbol

		Right side stroke adjustment unit									
		Without unit	A: With adjustment bolt			L: With low load shock absorber + Adjustment bolt			H: With high load shock absorber + Adjustment bolt		
			With short spacer	With long spacer	With short spacer	With long spacer	With short spacer	With long spacer	With short spacer	With long spacer	
Left side stroke adjustment unit	Without unit	—	SA	SA6	SA7	SL	SL6	SL7	SH	SH6	SH7
	A: With adjustment bolt	AS	A	AA6	AA7	AL	AL6	AL7	AH	AH6	AH7
	With short spacer	A6S	A6A	A6	A6A7	A6L	A6L6	A6L7	A6H	A6H6	A6H7
	With long spacer	A7S	A7A	A7A6	A7	A7L	A7L6	A7L7	A7H	A7H6	A7H7
	L: With low load shock absorber + Adjustment bolt	LS	LA	LA6	LA7	L	LL6	LL7	LH	LH6	LH7
	With short spacer	L6S	L6A	L6A6	L6A7	L6L	L6	L6L7	L6H	L6H6	L6H7
With long spacer	L7S	L7A	L7A6	L7A7	L7L	L7L6	L7	L7H	L7H6	L7H7	
H: With high load shock absorber + Adjustment bolt	HS	HA	HA6	HA7	HL	HL6	HL7	H	HH6	HH7	
With short spacer	H6S	H6A	H6A6	H6A7	H6L	H6L6	H6L7	H6H	H6	H6H7	
With long spacer	H7S	H7A	H7A6	H7A7	H7L	H7L6	H7L7	H7H	H7H6	H7	

\* Spacers are used to fix the stroke adjustment unit at an intermediate stroke position.  
 \* H: With high load shock absorber + Adjustment bolt is not available for 25A-MY1H16.

## Stroke adjustment unit mounting diagram

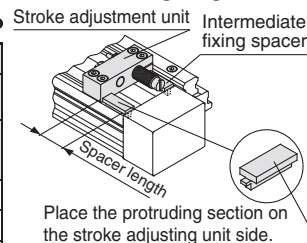

## Example of L6L7 attachment

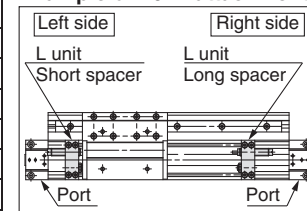

\* The 25A-series specifications and dimensions are the same as those of the standard model.



# Mechanically Jointed Rodless Cylinder Cam Follower Guide Type

# 25A-MY2C Series

∅ 16, ∅ 25, ∅ 40



## How to Order

**25A - MY2C 16 G - 300 - M9BW**

Series compatible with secondary batteries

Cam follower guide type

Bore size

16	16 mm
25	25 mm
40	40 mm

Port thread type

Symbol	Type	Bore size
—	M thread	∅ 16
	Rc	
TN	NPT	∅ 25, ∅ 40
TF	G	

Piping

G	Centralised piping type (Standard)
---	------------------------------------

Number of auto switches

—	2
S	1
n	n

Auto switch

—	Without auto switch (Built-in magnet)
---	---------------------------------------

\* Refer to page 205 for the applicable auto switch model.

Cylinder stroke [mm]

Bore size [mm]	Standard stroke [mm]*1	Max. manufacturable stroke [mm]
16	100, 200, 300, 400, 500, 600, 700, 800,	3000
25, 40	900, 1000, 1200, 1400, 1600, 1800, 2000	5000

\*1 Strokes are manufacturable in 1 mm increments, up to the maximum stroke. However, please be advised that with stroke 49 or less, there are cases where auto switch mounting is not possible and the performance of the air cushion may decline.

\* Long stroke can be ordered the same as the standard stroke.

MY2C25-3000L-M9BW

Stroke adjustment unit symbol

		Right side stroke adjustment unit						
		Without unit	L: With low load shock absorber			H: With high load shock absorber		
			With short spacer	With long spacer	With short spacer	With long spacer		
Left side stroke adjustment unit	Without unit	—	SL	SL6	SL7	SH	SH6	SH7
	L: With low load shock absorber	LS	L	LL6	LL7	LH	LH6	LH7
		With short spacer	L6S	L6L	L6	L6L7	L6H	L6H6
	With long spacer	L7S	L7L	L7L6	L7	L7H	L7H6	L7H7
	H: With high load shock absorber	HS	HL	HL6	HL7	H	HH6	HH7
		With short spacer	H6S	H6L	H6L6	H6L7	H6H	H6
With long spacer	H7S	H7L	H7L6	H7L7	H7H	H7H6	H7	

\* Spacers are used to fix the stroke adjustment unit at an intermediate stroke position.

Stroke adjustment unit mounting diagram

Intermediate fixing spacer Stroke adjustment unit

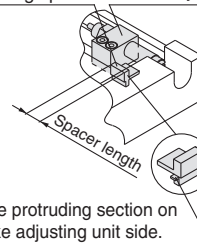

Place the protruding section on the stroke adjusting unit side.

Example of L6L7 attachment

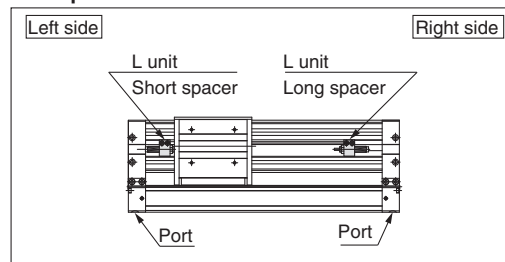

\* The 25A- series specifications and dimensions are the same as those of the standard model.

# Mechanically Jointed Rodless Cylinder Linear Guide Type

# 25A-MY2H/HT Series

∅ 16, ∅ 25, ∅ 40

RoHS



## How to Order

**25A - MY2 H 16** **G** - **300** - **M9BW**

Series compatible  
with secondary  
batteries

Guide type

<b>H</b>	Linear guide, Single axis
<b>HT</b>	Linear guide, Double axis

Bore size

<b>16</b>	16 mm
<b>25</b>	25 mm
<b>40</b>	40 mm

Port thread type

Symbol	Type	Bore size
—	M thread	∅ 16
	Rc	
<b>TN</b>	NPT	∅ 25, ∅ 40
<b>TF</b>	G	

Piping

<b>G</b>	Centralised piping type (Standard)
----------	------------------------------------

Number of auto switches

—	2
<b>S</b>	1
<b>n</b>	n

Auto switch

—	Without auto switch (Built-in magnet)
---	--

\* Refer to [page 205](#) for the applicable auto switch model.

Cylinder stroke [mm]

Bore size [mm]	Standard stroke [mm]*1	Max. manufacturable stroke [mm]
<b>16</b>	50, 100, 150, 200, 250, 300, 350, 400, 450, 500, 550, 600	1000
<b>25, 40</b>		1500

\*1 Strokes are manufacturable in 1 mm increments, up to the maximum stroke.

\* Intermediate stroke can be ordered the same as the standard stroke.

**MY2H10-60-M9BW**

\* Long stroke can be ordered the same as the standard stroke.

**MY2H20-800L-M9BW**

## Stroke adjustment unit mounting diagram

Intermediate fixing spacer Stroke adjustment unit

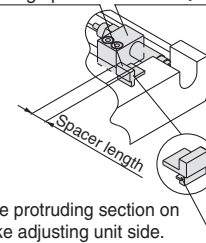

## Stroke adjustment unit symbol

		Right side stroke adjustment unit						
		Without unit	L: With low load shock absorber			H: With high load shock absorber		
			With short spacer	With long spacer	With short spacer	With long spacer		
Left side stroke adjustment unit	Without unit	—	SL	SL6	SL7	SH	SH6	SH7
	L: With low load shock absorber	LS	L	LL6	LL7	LH	LH6	LH7
		With short spacer	L6S	L6L	L6	L6L7	L6H	L6H6
	With long spacer	L7S	L7L	L7L6	L7	L7H	L7H6	L7H7
	H: With high load shock absorber	HS	HL	HL6	HL7	H	HH6	HH7
		With short spacer	H6S	H6L	H6L6	H6L7	H6H	H6
With long spacer	H7S	H7L	H7L6	H7L7	H7H	H7H6	H7	

\* Spacers are used to fix the stroke adjustment unit at an intermediate stroke position.

## Example of H6H7 attachment

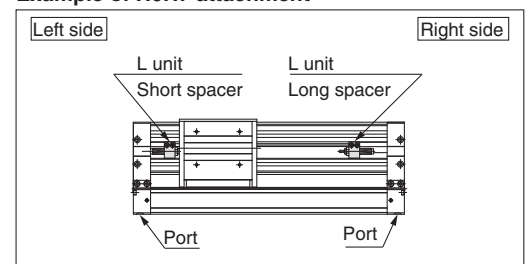

\* The 25A- series specifications and dimensions are the same as those of the standard model.

# Mechanically Jointed Rodless Cylinder/Basic Type

# 25A-MY3A/3B Series

∅ 16, ∅ 20, ∅ 25, ∅ 32, ∅ 40, ∅ 50, ∅ 63

RoHS

## How to Order



**25A - MY3 B 16 - 300 - M9BW**

Series compatible with secondary batteries

Type

A	Short type (Rubber bumper)
B	Standard type (Air cushion)

Cylinder bore size

16	16 mm
20	20 mm
25	25 mm
32	32 mm
40	40 mm
50	50 mm
63	63 mm

Port thread type

Symbol	Type	Bore size
—	M5	∅ 16, ∅ 20
	Rc	
TN	NPT	∅ 25, ∅ 32, ∅ 40
TF	G	∅ 50, ∅ 63

Number of auto switches

—	2
S	1
n	n

Auto switch

—	Without auto switch (Built-in magnet)
---	---------------------------------------

\* Refer to page 205 for auto switch model numbers.

Cylinder stroke [mm]

Bore size	Standard stroke*	Long stroke	Maximum manufacturable stroke
16, 20, 25, 32, 40, 50, 63	100, 200, 300, 400, 500, 600, 700, 800, 900, 1000, 1200, 1400, 1600, 1800, 2000 * The stroke can be manufactured in 1 mm increments from 1 mm stroke.	Strokes of 2001 to 3000 mm (1 mm increments) exceeding the standard stroke	3000

Ordering example

- \* Long stroke can be ordered the same as the standard stroke. 25A-MY3A25-3000L-M9BW
- \* Please be advised that with a stroke of 49 mm or less, there are cases where auto switch mounting is not possible, and the performance of the air cushion may decline.

Stroke adjustment unit symbol

		Right side stroke adjustment unit						
		Without unit	L: With low load shock absorber + Adjustment bolt			H: With high load shock absorber + Adjustment bolt		
			With short spacer	With long spacer	With short spacer	With long spacer	With short spacer	With long spacer
Left side stroke adjustment unit	Without unit	—	SL	SL6	SL7	SH	SH6	SH7
	L: With low load shock absorber + Adjustment bolt	LS	L	LL6	LL7	LH	LH6	LH7
	With short spacer	L6S	L6L	L6	L6L7	L6H	L6H6	L6H7
	With long spacer	L7S	L7L	L7L6	L7	L7H	L7H6	L7H7
	H: With high load shock absorber + Adjustment bolt	HS	HL	HL6	HL7	H	HH6	HH7
	With short spacer	H6S	H6L	H6L6	H6L7	H6H	H6	H6H7
With long spacer	H7S	H7L	H7L6	H7L7	H7H	H7H6	H7	

Stroke adjustment unit mounting diagram

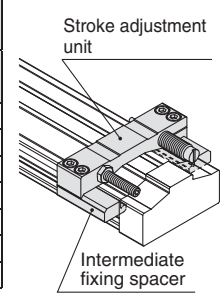

Example of L7L6 attachment

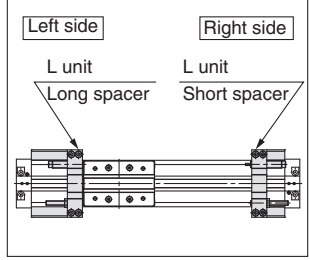

\* Spacers are used to fix the stroke adjustment unit at an intermediate stroke position.

\* The 25A- series specifications and dimensions are the same as those of the standard model.

# Mechanically Jointed Rodless Cylinder Slide Bearing Guide Type

# 25A-MY3M Series

∅ 16, ∅ 25, ∅ 40, ∅ 63



## How to Order

**25A-MY3 M 16**   **- 300**   **- M9BW**  

Series compatible  
with secondary  
batteries

Slide bearing guide type

Cylinder bore size

16	16 mm
25	25 mm
40	40 mm
63	63 mm

Port thread type

Symbol	Type	Bore size
—	M5	∅ 16
	Rc	
TN	NPT	∅ 25, ∅ 40, ∅ 63
TF	G	

Number of auto switches

—	2
S	1
n	n

Auto switch

—	Without auto switch (Built-in magnet)
---	---------------------------------------

\* Refer to [page 205](#) for auto switch model numbers.

Cylinder stroke [mm]

Bore size	Standard stroke*	Long stroke	Maximum manufacturable stroke
16, 25, 40, 63	100, 200, 300, 400, 500, 600, 700, 800, 900, 1000, 1200, 1400, 1600, 1800, 2000 * The stroke can be manufactured in 1 mm increments from 1 mm stroke.	Strokes of 2001 to 3000 mm (1 mm increments) exceeding the standard stroke	3000

Ordering example

\* Long stroke can be ordered the same as the standard stroke. 25A-MY3M25-3000L-M9BW

\* Please be advised that with a stroke of 49 mm or less, there are cases where auto switch mounting is not possible, and the performance of the air cushion may decline.

Stroke adjustment unit symbol

		Right side stroke adjustment unit						
		Without unit	L: With low load shock absorber + Adjustment bolt			H: With high load shock absorber + Adjustment bolt		
			With short spacer	With long spacer	With short spacer	With long spacer		
Left side stroke adjustment unit	Without unit	—	SL	SL6	SL7	SH	SH6	SH7
	L: With low load shock absorber + Adjustment bolt	LS	L	LL6	LL7	LH	LH6	LH7
	With short spacer	L6S	L6L	L6	L6L7	L6H	L6H6	L6H7
	With long spacer	L7S	L7L	L7L6	L7	L7H	L7H6	L7H7
	H: With high load shock absorber + Adjustment bolt	HS	HL	HL6	HL7	H	HH6	HH7
	With short spacer	H6S	H6L	H6L6	H6L7	H6H	H6	H6H7
With long spacer	H7S	H7L	H7L6	H7L7	H7H	H7H6	H7	

\* Spacers are used to fix the stroke adjustment unit at an intermediate stroke position.

Stroke adjustment unit mounting diagram

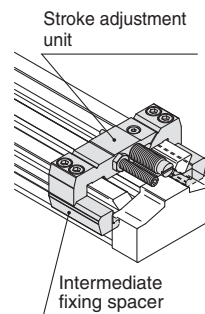

Example of L7L6 attachment

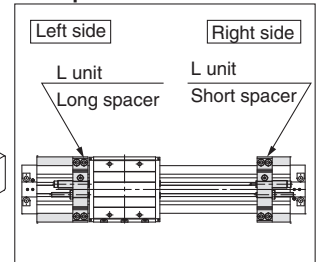

\* The 25A-series specifications and dimensions are the same as those of the standard model.

# Magnetically Coupled Rodless Cylinder/Basic Type

# 25A-CY3B Series

Ø 6, Ø 10, Ø 15, Ø 20, Ø 25, Ø 32, Ø 40, Ø 50, Ø 63

RoHS

## How to Order



**25A-CY3B** **25** **□** - **300**

Series compatible with secondary batteries

Basic type

Bore size

<b>6</b>	6 mm
<b>10</b>	10 mm
<b>15</b>	15 mm
<b>20</b>	20 mm
<b>25</b>	25 mm
<b>32</b>	32 mm
<b>40</b>	40 mm
<b>50</b>	50 mm
<b>63</b>	63 mm

Port thread type

Symbol	Type	Bore size
—	M thread	6, 10, 15
—	Rc	20, 25, 32, 40
<b>TN</b>	NPT	50, 63
<b>TF</b>	G	

Standard stroke [mm]

Bore size	Standard stroke	Max. manufacturable stroke
<b>6</b>	50, 100, 150, 200	300
<b>10</b>	50, 100, 150, 200, 250, 300	500
<b>15</b>	50, 100, 150, 200, 250, 300, 350 400, 450, 500	1000
<b>20</b>	100, 150, 200, 250, 300, 350 400, 450, 500, 600, 700, 800	1500
<b>25</b>		2000
<b>32</b>		
<b>40, 50, 63</b>	100, 150, 200, 250, 300, 350, 400 450, 500, 600, 700, 800, 900, 1000	

- \* Please contact SMC if the maximum stroke is exceeded.
- \* The longer the stroke, the larger the amount of deflection in a cylinder tube. Pay attention to the mounting bracket and clearance value.
- \* Intermediate stroke is available in 1 mm increments.

\* The 25A- series specifications and dimensions are the same as those of the standard model.

# Magnetically Coupled Rodless Cylinder/Direct Mount Type

# 25A-CY3R Series

Ø 6, Ø 10, Ø 15, Ø 20, Ø 25, Ø 32, Ø 40, Ø 50, Ø 63

RoHS

## How to Order



**25A-CY3R**    **25**    - **300**    - **M9BWL**   

Series compatible with secondary batteries

Direct mount type

### Piping type

—	Standard type
<b>G</b>	Centralised piping type

\* Type G (centralised piping) is not available for Ø 6.

### Bore size

<b>6</b>	6 mm
<b>10</b>	10 mm
<b>15</b>	15 mm
<b>20</b>	20 mm
<b>25</b>	25 mm
<b>32</b>	32 mm
<b>40</b>	40 mm
<b>50</b>	50 mm
<b>63</b>	63 mm

### Port thread type

Symbol	Type	Bore size
—	M thread	6, 10, 15
	Rc	20, 25, 32, 40, 50, 63
<b>TN</b>	NPT	
<b>TF</b>	G	

### Number of auto switches

—	2
<b>S</b>	1
<b>n</b>	n

### Auto switch

—	Ø 6 to Ø 15	Without auto switch (Built-in magnet)
	Ø 25 to Ø 63	
<b>M</b>	Ø 20	Without auto switch (Built-in magnet for reed switch)
		Without auto switch (Built-in magnet for solid state switch)

\* Refer to [page 205](#) for the applicable auto switch model.

### Switch rail

—	With switch rail
<b>N</b>	Without switch rail

- \* A type with switch rail has built-in auto switch magnets.
- \* Ø 15 has built-in auto switch magnets even without switch rail.
- \* Centralised piping type (G) is not available without switch rail (N).

### Cylinder stroke [mm]

Bore size	Standard stroke	Max. stroke without switch	Max. stroke with switch
<b>6</b>	50, 100, 150, 200	300	300
<b>10</b>	50, 100, 150, 200, 250, 300	500	500
<b>15</b>	50, 100, 150, 200, 250, 300, 350, 400, 450, 500	1000	750
<b>20</b>	100, 150, 200, 250, 300, 350, 400, 450, 500, 600, 700, 800	1500	1000
<b>25</b>			1200
<b>32</b>			
<b>40, 50, 63</b>	100, 150, 200, 250, 300, 350, 400, 450, 500, 600, 700, 800, 900, 1000	2000	1500

- \* The longer the stroke, the larger the amount of deflection in a cylinder tube. Pay attention to the mounting bracket and clearance value.
- \* Intermediate stroke is available in 1 mm increments.

\* The 25A-series specifications and dimensions are the same as those of the standard model.

# Compact Slide

# 25A-MXH Series

∅ 6, ∅ 10, ∅ 16, ∅ 20

RoHS

## How to Order

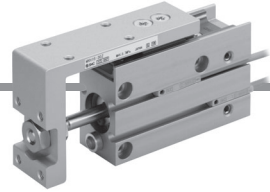

**25A - MXH 10 - 60 Z - M9BW**  

Series compatible with secondary batteries

Compact slide

Bore size

6	6 mm
10	10 mm
16	16 mm
20	20 mm

Number of auto switches

—	2
S	1

Auto switch

—	Without auto switch (Built-in magnet)
---	---------------------------------------

\* For applicable auto switch model, refer to [page 207](#).

Cylinder stroke [mm]

6, 10, 16, 20	5, 10, 15, 20, 25, 30, 40 50, 60
---------------	-------------------------------------

\* The 25A- series specifications and dimensions are the same as those of the standard model.



# Air Slide Table

## 25A-MXS Series

∅ 6, ∅ 8, ∅ 12, ∅ 16, ∅ 20, ∅ 25

RoHS



### How to Order

Air slide table

25A - MXS 16 [ ] [ ] - 50 AS - M9BW [ ]

Series compatible with secondary batteries

#### Port thread type

—	M thread	∅ 6 to ∅ 16
	Rc	
TN	NPT	∅ 20, ∅ 25
TF	G	

#### Symmetric type

—	Standard type
L	Symmetric type

#### Bore size (Standard stroke [mm])

6	10, 20, 30, 40, 50
8	10, 20, 30, 40, 50, 75
12	10, 20, 30, 40, 50, 75, 100
16	10, 20, 30, 40, 50, 75, 100, 125
20	10, 20, 30, 40, 50, 75, 100, 125, 150
25	10, 20, 30, 40, 50, 75, 100, 125, 150

#### Number of auto switches

—	2
S	1
n	n

#### Auto switch

—	Without auto switch (Built-in magnet)
---	---------------------------------------

\* Refer to page 207 for auto switch model numbers.

#### Adjuster option

—	Without adjuster
AS	Adjuster on extension end
AT	Adjuster on retraction end
A	Adjuster on both ends
BS	Absorber on extension end
BT	Absorber on retraction end
B	Absorber on both ends
ASBT	Adjuster on extension end + Absorber on retraction end
BSAT	Absorber on extension end + Adjuster on retraction end

\* With shock absorber is not available in the 25A-MXS6 series.

\* When the adjuster option with shock absorber is used, metal-to-metal collisions occur, and may generate dust particles.

### Corrosion Resistant Air Slide Table

(Made to order: 25A-MXS□-X1949)

The material of the head cap part has been changed to a highly corrosion-resistant material.

Please contact your local sales representative for more details.

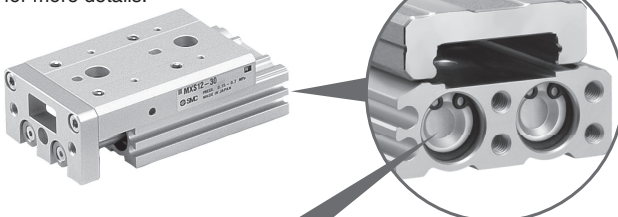

	After change	Before change
Head cap	Aluminium	Synthetic resin

\* The 25A- series specifications and dimensions are the same as those of the standard model.

# Air Slide Table Double-ported Type

RoHS

# 25A-MXQ□A Series

∅ 6, ∅ 8, ∅ 12, ∅ 16, ∅ 20, ∅ 25

## How to Order

25A-MXQ 12 A - 30 ZA □ - M9BW □

Series compatible with secondary batteries

1 2 3 4 5 6 7



1 Bore size	2 Body option: Double-ported type A	3 Standard stroke [mm]
6		10, 20, 30, 40, 50
8		10, 20, 30, 40, 50, 75
12		10, 20, 30, 40, 50, 75, 100
16		10, 20, 30, 40, 50, 75, 100, 125
20		10, 20, 30, 40, 50, 75, 100, 125, 150
25		10, 20, 30, 40, 50, 75, 100, 125, 150*

\* The operating speed range of the stroke marked with an asterisk (\*) is 50 to 300 mm/s. (Without stroke adjuster)

## 5 Functional options

Symbol	Functional option
—	Without functional option
1	With buffer
2	With end lock
3	Axial piping
4	With buffer, end lock
5	With buffer, axial piping

## 7 Number of auto switches

—	2
S	1
n	n

## 6 Auto switch

—	Without auto switch (Built-in magnet)
---	---------------------------------------

\* For applicable auto switches, refer to [page 207](#).

## 4 Adjuster options/Functional option combinations

Symbol	Adjuster type*6	Adjuster mounting position*1		Functional option combination					
		Extension stroke end	Retraction stroke end	— Without functional option	1 With buffer *2*7	2 With end lock	3 Axial piping *5	4 With buffer, end lock *2*7	5 With Buffer, axial piping *2*5*7
Z	Without adjuster			○	○	○	○	○	○
ZA	Metal stopper with bumper	●	●	○	×	×	○	×	×
ZB		●	●	○	×	○	○	×	×
ZC	Rubber stopper	●	●	○	×	×	○	×	×
ZD		●	●	○	○	○	○	○	○
ZE	Shock absorber/RJ	●	●	○	×	×	○	×	×
ZF		●	●	○	×	×	○	×	×
ZG	Metal stopper	●	●	○	×	×	○	×	×
ZH		●	●	○	×	×	○	×	×
ZI	Shorter total length type*3	●	●	○	×	×	○	×	×
ZJ		●	●	○	×	×	○	×	×
ZK	Retraction stroke end adjuster	●	●	○	×	×	○	×	×
ZL		●	●	○	×	×	○	×	×
ZM	Without adjuster	●	●	○	×	×	○	×	×
ZN		●	●	○	○*4	×	○	×	○*4
ZP	Rubber stopper	●	●	○	×	×	○	×	×
ZQ		●	●	○	×	×	○	×	×
ZR	Shock absorber/RJ	●	●	○	×	×	○	×	×
ZS		●	●	○	×	×	○	×	×
ZT	Metal stopper with bumper	●	●	○	×	×	○	×	×
ZU		●	●	○	×	×	○	×	×
ZV	Rubber stopper	●	●	○	×	×	○	×	×
ZW		●	●	○	×	×	○	×	×
ZX	Shock absorber/RJ	●	●	○	×	×	○	×	×
ZY		●	●	○	×	×	○	×	×
ZZ	Metal stopper	●	●	○	×	×	○	×	×
ZAA		●	●	○	×	×	○	×	×
ZAB	Rubber stopper	●	●	○	×	×	○	×	×
ZAC		●	●	○	×	×	○	×	×
ZAD	Shock absorber/RJ	●	●	○	×	×	○	×	×
ZAE		●	●	○	×	×	○	×	×
ZAF	Metal stopper	●	●	○	×	×	○	×	×
ZAG		●	●	○	×	×	○	×	×
ZAH	Rubber stopper	●	●	○	×	×	○	×	×
ZAI		●	●	○	×	×	○	×	×
ZAJ	Shock absorber/RJ	●	●	○	×	×	○	×	×
ZAK		●	●	○	×	×	○	×	×
ZAL	Metal stopper	●	●	○	×	×	○	×	×
ZAM		●	●	○	×	×	○	×	×
ZAN	Rubber stopper	●	●	○	×	×	○	×	×
ZAO		●	●	○	×	×	○	×	×
ZAP	Shock absorber/RJ	●	●	○	×	×	○	×	×
ZAQ		●	●	○	×	×	○	×	×
ZAR	Metal stopper	●	●	○	×	×	○	×	×
ZAS		●	●	○	×	×	○	×	×
ZAT	Rubber stopper	●	●	○	×	×	○	×	×
ZAU		●	●	○	×	×	○	×	×
ZAV	Shock absorber/RJ	●	●	○	×	×	○	×	×
ZAW		●	●	○	×	×	○	×	×
ZAX	Metal stopper	●	●	○	×	×	○	×	×
ZAY		●	●	○	×	×	○	×	×
ZAZ	Rubber stopper	●	●	○	×	×	○	×	×
ZBA		●	●	○	×	×	○	×	×
ZBB	Shock absorber/RJ	●	●	○	×	×	○	×	×
ZBC		●	●	○	×	×	○	×	×
ZBD	Metal stopper	●	●	○	×	×	○	×	×
ZBE		●	●	○	×	×	○	×	×
ZBF	Rubber stopper	●	●	○	×	×	○	×	×
ZBG		●	●	○	×	×	○	×	×
ZBH	Shock absorber/RJ	●	●	○	×	×	○	×	×
ZBI		●	●	○	×	×	○	×	×
ZBJ	Metal stopper	●	●	○	×	×	○	×	×
ZBK		●	●	○	×	×	○	×	×
ZBL	Rubber stopper	●	●	○	×	×	○	×	×
ZBM		●	●	○	×	×	○	×	×
ZBN	Shock absorber/RJ	●	●	○	×	×	○	×	×
ZBO		●	●	○	×	×	○	×	×
ZBP	Metal stopper	●	●	○	×	×	○	×	×
ZBQ		●	●	○	×	×	○	×	×
ZBR	Rubber stopper	●	●	○	×	×	○	×	×
ZBS		●	●	○	×	×	○	×	×
ZBT	Shock absorber/RJ	●	●	○	×	×	○	×	×
ZBU		●	●	○	×	×	○	×	×
ZBV	Metal stopper	●	●	○	×	×	○	×	×
ZBW		●	●	○	×	×	○	×	×
ZBX	Rubber stopper	●	●	○	×	×	○	×	×
ZBY		●	●	○	×	×	○	×	×
ZBZ	Shock absorber/RJ	●	●	○	×	×	○	×	×
ZCA		●	●	○	×	×	○	×	×

- \*1 ●: Shipped together with the product, but not assembled. Without any symbol for the adjuster mounting position: The adjuster can be mounted afterward.
- \*2 For the buffer mechanism, the buffer stroke will be shorter for the stroke that is adjusted by the extension stroke end adjuster.
- \*3 Extension stroke end adjuster mounting holes have been removed to reduce the total length of the table.
- \*4 The shorter total length type can be used, but a retraction stroke end adjuster cannot be mounted afterward.
- \*5 There is no piping port on the side surface of the product.
- \*6 The metal stopper with bumper option is not available for ∅ 6.
- \*7 As there is no magnet in the buffer mechanism, auto switches cannot be used on the buffer part.

## Adjuster Mounting Position

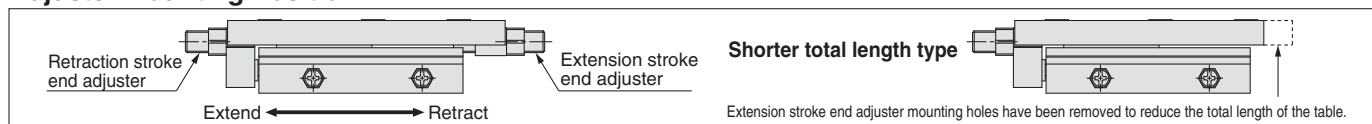

- \* When the shock absorber, metal stopper with bumper, or adjuster option with metal stopper is used, metal-to-metal collisions occur, and may generate dust particles.
- \* When the buffer mechanism or the end lock mechanism functional options are used, dust particles may be generated by the buffer part as well as the end lock part.

\* The 25A-series specifications and dimensions are the same as those of the standard model.

# Air Slide Table

## Low Thrust with High Rigidity Type



# 25A-MXQ□B Series

∅ 6, ∅ 8, ∅ 12, ∅ 16, ∅ 20

### How to Order



25A - MXQ 12 B - 30 ZA - M9BW  

Series compatible with secondary batteries

1 2 3 4 5 6

1 Bore size	2 Body option		3 Standard stroke [mm]
	Standard type B	Symmetric type BL	
6			10, 20, 30, 40, 50*, 75*
8			10, 20, 30, 40, 50, 75*, 100*
12			10, 20, 30, 40, 50, 75, 100, 125
16		—*1	10, 20, 30, 40, 50, 75, 100*, 125*, 150*
20			10, 20, 30, 40, 50, 75, 100, 125*, 150*

\*1 Not available, as the standard model has piping ports and auto switch mounting grooves on both sides. Please use the standard type.

\* The operating speed range of the strokes marked with an asterisk (\*) is 50 to 300 mm/s. (Without stroke adjuster)

#### 4 Adjuster options

Symbol	Adjuster type*3	Adjuster mounting position*1	
		Extension stroke end	Retraction stroke end
Z	Without adjuster		
ZA		●	●
ZB	Metal stopper with bumper	●	
ZC			●
ZD		●	●
ZE	Rubber stopper	●	
ZF			●
ZG		●	●
ZH	Shock absorber/RJ	●	
ZJ			●
ZK		●	●
ZL	Metal stopper	●	
ZM			●
ZN	Shorter total length type*2	Without adjuster	
ZP		Rubber stopper	●
ZQ		Shock absorber/RJ	●
ZR		Metal stopper with bumper	●
ZS		Metal stopper	●
ZT	Retraction stroke end adjuster	Rubber stopper	●
ZU		Shock absorber/RJ	●
ZV	Extension stroke end adjuster	Metal stopper with bumper	●
ZW		Shock absorber/RJ	●
ZX	Metal stopper with bumper	Metal stopper	●
ZY		Metal stopper with bumper	●
ZZ	Rubber stopper	Shock absorber/RJ	●
ZAA		Shock absorber/RJ	●
ZAB	Shock absorber/RJ	Metal stopper	●
ZAC		Metal stopper with bumper	●
ZAD	Metal stopper	Rubber stopper	●
ZAE		Rubber stopper	●
ZAF	Metal stopper with bumper	Metal stopper	●
ZAG		Metal stopper with bumper	●
ZAH	Metal stopper	Rubber stopper	●
ZAI		Rubber stopper	●
ZAJ	Metal stopper	Shock absorber/RJ	●
ZAK		Shock absorber/RJ	●

#### 5 Auto switch

— Without auto switch (Built-in magnet)

\* For applicable auto switches, refer to page 207.

#### 6 Number of auto switches

—	2
S	1
n	n

\*1 ●: Shipped together with the product, but not assembled  
Without any symbol for the adjuster mounting position: The adjuster can be mounted afterward.

\*2 Extension stroke end adjuster mounting holes have been removed to reduce the total length of the table.

\*3 The metal stopper with bumper option is not available for ∅ 6.

#### Adjuster Mounting Position

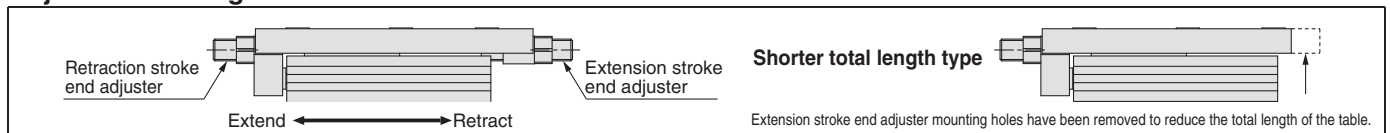

\* When the buffer mechanism or the end lock mechanism functional options are used, dust particles may be generated by the buffer part as well as the end lock part.

\* The 25A- series specifications and dimensions are the same as those of the standard model.

# Air Slide Table

## Single Side-ported Type

# 25A-MXQ□C Series

∅ 8, ∅ 12

RoHS

### How to Order

25A-MXQ 12 C - 30 ZA □ - M9BW □

Series compatible with secondary batteries



1 Bore size	2 Body option		3 Standard stroke [mm]
	Standard type C	Symmetric type CL	
8	Port Switch mounting groove	Switch mounting groove Port	10, 20, 30, 40, 50, 75
12			10, 20, 30, 40, 50, 75, 100

5 Symbol	Functional option
—	Without functional option
1	With buffer
2	With end lock
3	Axial piping
4	With buffer, end lock
5	With buffer, axial piping

6 Symbol	Auto switch
—	Without auto switch (Built-in magnet)

\* For applicable auto switches, refer to page 207.

7 Symbol	Number of auto switches
—	2
S	1
n	n

#### 4 Adjuster options/Functional option combinations

Symbol	Adjuster type		Adjuster mounting position*1		Functional option combination					
					—	1	2	3	4	5
			Extension stroke end	Retraction stroke end	Without functional option	*2*6 With buffer	With end lock	Axial piping *5	*2*6 With buffer, end lock	*3*5*6 With buffer, axial piping
Z	Without adjuster				○	○	○	○	○	○
ZA	Metal stopper with bumper		●	●	○	×	×	○	×	×
ZB	Metal stopper with bumper		●	●	○	×	○	○	×	×
ZC	Metal stopper with bumper			●	○	×	×	○	×	×
ZD	Rubber stopper		●	●	○	×	×	○	×	×
ZE	Rubber stopper		●	●	○	○	○	○	○	○
ZF	Rubber stopper		●	●	○	×	×	○	×	×
ZG	Rubber stopper		●	●	○	×	×	○	×	×
ZH	Shock absorber/RJ		●	●	○	×	○	○	×	×
ZJ	Shock absorber/RJ		●	●	○	×	×	○	×	×
ZK	Metal stopper		●	●	○	×	×	○	×	×
ZL	Metal stopper		●	●	○	○	○	○	○	○
ZM	Metal stopper			●	○	×	×	○	×	×
ZN	Shorter overall length type*3				○	○*4	×	○	×	○*4
ZP	Shorter overall length type*3				○	×	×	○	×	×
ZQ	Shorter overall length type*3				○	×	×	○	×	×
ZR	Shorter overall length type*3				○	×	×	○	×	×
ZS	Shorter overall length type*3				○	×	×	○	×	×
ZT	Shorter overall length type*3				○	×	×	○	×	×
ZBF	Metal stopper with bumper	Retraction stroke end adjuster	●	●	○	×	×	○	×	×
ZBJ		Extension stroke end adjuster	●	●	○	×	×	○	×	×
ZBM	Rubber stopper	Retraction stroke end adjuster	●	●	○	×	×	○	×	×
ZBZ		Extension stroke end adjuster	●	●	○	×	×	○	×	×
ZCJ	Shock absorber/RJ	Retraction stroke end adjuster	●	●	○	×	×	○	×	×
ZCZ		Extension stroke end adjuster	●	●	○	×	×	○	×	×
ZDJ	Metal stopper	Retraction stroke end adjuster	●	●	○	×	×	○	×	×
ZDZ		Extension stroke end adjuster	●	●	○	×	×	○	×	×
ZEJ	Metal stopper with bumper	Retraction stroke end adjuster	●	●	○	×	×	○	×	×
ZEZ		Extension stroke end adjuster	●	●	○	×	×	○	×	×
ZFJ	Rubber stopper	Retraction stroke end adjuster	●	●	○	×	×	○	×	×
ZFZ		Extension stroke end adjuster	●	●	○	×	×	○	×	×
ZGJ	Shock absorber/RJ	Retraction stroke end adjuster	●	●	○	×	×	○	×	×
ZGZ		Extension stroke end adjuster	●	●	○	×	×	○	×	×
ZHJ	Metal stopper	Retraction stroke end adjuster	●	●	○	×	×	○	×	×
ZHZ		Extension stroke end adjuster	●	●	○	×	×	○	×	×
ZIJ	Metal stopper with bumper	Retraction stroke end adjuster	●	●	○	×	×	○	×	×
ZIZ		Extension stroke end adjuster	●	●	○	×	×	○	×	×
ZLJ	Metal stopper	Retraction stroke end adjuster	●	●	○	×	×	○	×	×
ZLZ		Extension stroke end adjuster	●	●	○	×	×	○	×	×

- \*1 ●: Shipped together with the product, but not assembled Without any symbol for the adjuster mounting position: The adjuster can be mounted afterward.
- \*2 For the buffer mechanism, the buffer stroke will be shorter for the stroke that is adjusted by the extension stroke end adjuster.
- \*3 Extension stroke end adjuster mounting holes have been removed to reduce the total length of the table.
- \*4 The shorter total length type can be used, but a retraction stroke end adjuster cannot be mounted afterward.
- \*5 There is no piping port on the side surface of the product.
- \*6 As there is no magnet in the buffer mechanism, auto switches cannot be used on the buffer part.

#### Adjuster Mounting Position

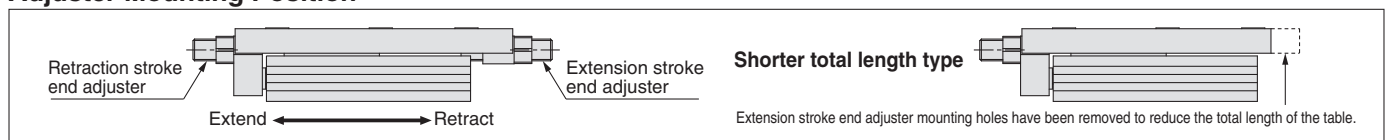

- \* When the shock absorber, metal stopper with bumper, or adjuster option with metal stopper is used, metal-to-metal collisions occur, and may generate dust particles.
- \* When the buffer mechanism or the end lock mechanism functional options are used, dust particles may be generated by the buffer part as well as the end lock part.

\* The 25A- series specifications and dimensions are the same as those of the standard model.

# Air Slide Table

## Height Interchangeable Type

# 25A-MXQ Series

∅ 6, ∅ 8, ∅ 12, ∅ 16, ∅ 20, ∅ 25

RoHS

### How to Order

25A-MXQ 12   - 30 ZA   - M9BW  

Series compatible with secondary batteries

1 2 3 4 5 6 7



1 Bore size	2 Body option		3 Standard stroke [mm]
	Standard type	Symmetric type	
6	—	L	10, 20, 30, 40, 50
8	Port	Switch mounting groove	10, 20, 30, 40, 50, 75
12	Switch mounting groove	Port	10, 20, 30, 40, 50, 75, 100
16	Switch mounting groove	—*1	10, 20, 30, 40, 50, 75, 100, 125
20	Switch mounting groove	—*1	10, 20, 30, 40, 50, 75, 100, 125, 150
25	Port	Port	10, 20, 30, 40, 50, 75, 100, 125, 150*

\*1 Not available, as the standard model has piping ports and auto switch mounting grooves on both sides. Please use the standard type.  
\* The operating speed range of the stroke marked with an asterisk (\*) is 50 to 300 mm/s. (Without stroke adjuster)

### 5 Functional options

Symbol	Functional option
—	Without functional option
1	With buffer
2	With end lock
3	Axial piping
4	With buffer, end lock
5	With buffer, axial piping

### 7 Number of auto switches

—	2
S	1
n	n

### 6 Auto switch

— Without auto switch (Built-in magnet)

\* For applicable auto switches, refer to [page 207](#).

### 4 Adjuster options/Functional option combinations

Symbol	Adjuster type*6		Adjuster mounting position*1		Functional option combination					
			Extension stroke end	Retraction stroke end	—	1	2	3	4	5
Z	Without adjuster		○	○	○	○	○	○	○	○
ZA	Metal stopper with bumper		●	●	○	×	×	○	×	×
ZB	Metal stopper with bumper		●	●	○	×	○	○	×	×
ZC	Metal stopper with bumper		●	●	○	×	×	○	×	×
ZD	Metal stopper with bumper		●	●	○	×	×	○	×	×
ZE	Rubber stopper		●	●	○	○	○	○	○	○
ZF	Rubber stopper		●	●	○	×	×	○	×	×
ZG	Rubber stopper		●	●	○	×	×	○	×	×
ZH	Shock absorber/RJ		●	●	○	×	○	○	×	×
ZJ	Shock absorber/RJ		●	●	○	×	×	○	×	×
ZK	Shock absorber/RJ		●	●	○	×	×	○	×	×
ZL	Metal stopper		●	●	○	○	○	○	○	○
ZM	Metal stopper		●	●	○	×	×	○	×	×
ZN	Shorter total length type*3		○	○	○	○*4	×	○	×	○*4
ZP	Shorter total length type*3		●	●	○	×	×	○	×	×
ZQ	Shorter total length type*3		●	●	○	×	×	○	×	×
ZS	Shorter total length type*3		●	●	○	×	×	○	×	×
ZT	Shorter total length type*3		●	●	○	×	×	○	×	×
ZBF	Metal stopper with bumper	Retraction stroke end adjuster	●	●	○	×	×	○	×	×
ZBJ		Extension stroke end adjuster	●	●	○	×	×	○	×	×
ZBM	Metal stopper with bumper	Retraction stroke end adjuster	●	●	○	×	×	○	×	×
ZBC		Extension stroke end adjuster	●	●	○	×	×	○	×	×
ZEC	Rubber stopper	Retraction stroke end adjuster	●	●	○	×	×	○	×	×
ZEJ		Extension stroke end adjuster	●	●	○	×	×	○	×	×
ZEM	Rubber stopper	Retraction stroke end adjuster	●	●	○	×	×	○	×	×
ZEM		Extension stroke end adjuster	●	●	○	×	×	○	×	×
ZHC	Shock absorber/RJ	Retraction stroke end adjuster	●	●	○	×	×	○	×	×
ZHF		Extension stroke end adjuster	●	●	○	×	×	○	×	×
ZHM	Shock absorber/RJ	Retraction stroke end adjuster	●	●	○	×	×	○	×	×
ZHM		Extension stroke end adjuster	●	●	○	×	×	○	×	×
ZLC	Metal stopper	Retraction stroke end adjuster	●	●	○	×	×	○	×	×
ZLF		Extension stroke end adjuster	●	●	○	×	×	○	×	×
ZLJ	Metal stopper	Retraction stroke end adjuster	●	●	○	×	×	○	×	×
ZLJ		Extension stroke end adjuster	●	●	○	×	×	○	×	×

- \*1 ●: Shipped together with the product, but not assembled. Without any symbol for the adjuster mounting position: The adjuster can be mounted afterward.
- \*2 For the buffer mechanism, the buffer stroke will be shorter for the stroke that is adjusted by the extension stroke end adjuster.
- \*3 Extension stroke end adjuster mounting holes have been removed to reduce the total length of the table.
- \*4 The shorter total length type can be used, but a retraction stroke end adjuster cannot be mounted afterward.
- \*5 There is no piping port on the side surface of the product.
- \*6 The metal stopper with bumper option is not available for ∅ 6.
- \*7 As there is no magnet in the buffer mechanism, auto switches cannot be used on the buffer part.

### Adjuster Mounting Position

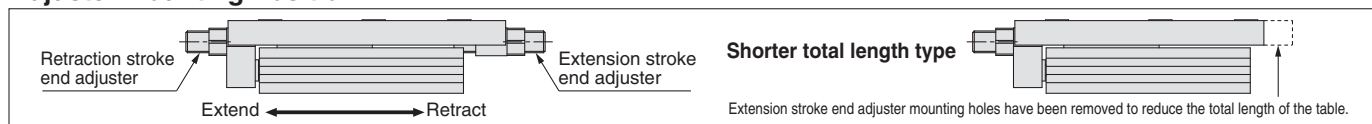

- \* When the shock absorber, metal stopper with bumper, or adjuster option with metal stopper is used, metal-to-metal collisions occur, and may generate dust particles.
- \* When the buffer mechanism or the end lock mechanism functional options are used, dust particles may be generated by the buffer part as well as the end lock part.

- \* The 25A-series specifications and dimensions are the same as those of the standard model.



# Air Slide Table

# 25A-MXQ Series

∅ 6, ∅ 8, ∅ 12, ∅ 16, ∅ 20, ∅ 25

## How to Order



**25A-MXQ 16**   - **50 AS** - **M9BW**

- Series compatible with secondary batteries

### Port thread type

—	M thread	∅ 6 to ∅ 16
	Rc	
TN	NPT	∅ 20, ∅ 25
TF	G	

### Symmetric type

—	Standard type
L	Symmetric type

### Bore size (Standard stroke [mm])

<b>6</b>	10, 20, 30, 40, 50
<b>8</b>	10, 20, 30, 40, 50, 75
<b>12</b>	10, 20, 30, 40, 50, 75, 100
<b>16</b>	10, 20, 30, 40, 50, 75, 100, 125
<b>20</b>	10, 20, 30, 40, 50, 75, 100, 125, 150
<b>25</b>	10, 20, 30, 40, 50, 75, 100, 125, 150

### Number of auto switches

—	2
S	1
n	n

### Auto switch

—	Without auto switch (Built-in magnet)
---	---------------------------------------

\* Refer to [page 207](#) for auto switch model numbers.

### Adjuster option

—	Without adjuster
AS	Extension end rubber stopper
AT	Retraction end rubber stopper
A	Both ends rubber stopper
BS	Extension end absorber
BT	Retraction end absorber
B	Double absorber
CS	Extension end metal stopper
CT	Retraction end metal stopper
C	Double metal stopper
ASBT	Extension end adjuster + Retraction end absorber
ASCT	Extension end adjuster + Retraction end metal stopper
BSAT	Extension end absorber + Retraction end adjuster
BSCT	Extension end absorber + Retraction end metal stopper
CSAT	Extension end metal stopper + Retraction end adjuster
CSBT	Extension end metal stopper + Retraction end absorber

\* With shock absorber is not available in the 25A-MXQ6 series.

\* When the adjuster option with shock absorber or metal stopper is used, metal-to-metal collisions occur, and may generate dust particles.

## Corrosion Resistant Air Slide Table

(Made to order: 25A-MXQ□-X771)

The material of the head cap part has been changed to a highly corrosion-resistant material.

Please contact your local sales representative for more details.

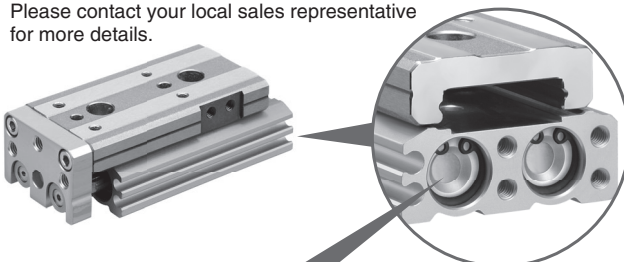

	After change	Before change
Head cap	Aluminium	Synthetic resin

\* The 25A- series specifications and dimensions are the same as those of the standard model.

# Air Slide Table

RoHS

# 25A-MXW Series

∅ 8, ∅ 12, ∅ 16, ∅ 20, ∅ 25



## How to Order

Series compatible with secondary batteries

25A – MXW 16 [ ] – 100 B – M9BW [ ]

**Port thread type**

—	M thread	∅ 8 to ∅ 16
TN	Rc	∅ 20, ∅ 25
TF	NPT	
	G	

**Bore size (Standard stroke [mm])**

8	25, 50, 75, 100, 125, 150
12	50, 75, 100, 125, 150
16	75, 100, 125, 150, 175, 200
20	100, 125, 150, 175, 200, 225, 250
25	100, 125, 150, 175, 200, 225, 250, 275, 300

**Number of auto switches**

—	2
S	1
n	n

**Auto switch**

—	Without auto switch (Built-in magnet)
---	---------------------------------------

\* Refer to [page 207](#) for applicable auto switches.

**Option**

—	Standard (With urethane bumper)
B	With shock absorbers 2 pcs.

\* When the adjuster option with shock absorber is used, metal-to-metal collisions occur, and may generate dust particles.

\* The 25A- series specifications and dimensions are the same as those of the standard model.



# Air Slide Table

# 25A-MXP Series

∅ 6, ∅ 8, ∅ 10, ∅ 12, ∅ 16



## How to Order

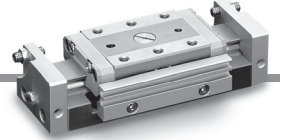

**25A - MXP** **12** - **15**   - **M9BW**

Series compatible with secondary batteries

Bore size (Standard stroke [mm])

6	5, 10
8	10, 20
10	10, 20
12	15, 25
16	20, 30

Adjuster option

—	Rubber stopper
B	Shock absorber
C	Metal stopper

Number of auto switches

—	2
S	1
n	n

\* In the case of 25A-MXP6-5, with 2 auto switches are available for D-M9□ type and D-M9□V type only. For other switches, no other choice is affordable but with 1 piece attached (symbol: S).

Auto switch

—	Without auto switch (Built-in magnet)
---	---------------------------------------

\* Refer to page 207 for auto switch model numbers.

Magnet/Switch rail

—	With magnet and rail
N	Without magnet and rail

\* Auto switch cannot be mounted on type N (without magnet and rail).

- \* Adjuster for 25A-MXP6 series is available for one side only.
- \* Shock absorber is not available in 25A-MXP6 and 25A-MXP8 series.
- \* When the adjuster option with shock absorber or metal stopper is used, metal-to-metal collisions occur, and may generate dust particles.

\* The 25A- series specifications and dimensions are the same as those of the standard model.

# Compact Guide Cylinder



# 25A-MGP Series

Ø 12, Ø 16, Ø 20, Ø 25, Ø 32, Ø 40, Ø 50, Ø 63, Ø 80, Ø 100



## How to Order

**25A - MGP M 25 - 30 Z - M9BW**

Series compatible with secondary batteries

Compact guide cylinder

Bearing type

M	Slide bearing
L	Ball bushing

Bore size

12	12 mm
16	16 mm
20	20 mm
25	25 mm
32	32 mm
40	40 mm
50	50 mm
63	63 mm
80	80 mm
100	100 mm

Cylinder stroke [mm]

<b>12, 16</b>	10, 20, 30, 40, 50, 75, 100, 125, 150, 175, 200, 250
<b>20, 25</b>	20, 30, 40, 50, 75, 100, 125, 150, 175, 200, 250, 300, 350, 400
<b>32 to 100</b>	25, 50, 75, 100, 125, 150, 175, 200, 250, 300, 350, 400

Port thread type

—	M5 x 0.8
	Rc
TN	NPT
TF	G

\* For bore sizes Ø 12 and Ø 16, only M5 x 0.8 is available.

Number of auto switches

—	2
S	1
n	n

Auto switch

—	Without auto switch (Built-in magnet)
---	---------------------------------------

\* For applicable auto switches, refer to [page 207](#).

\* The 25A- series specifications and dimensions are the same as those of the standard model.

# Compact Guide Cylinder/With Air Cushion

# 25A-MGP Series

∅ 16, ∅ 20, ∅ 25, ∅ 32, ∅ 40, ∅ 50, ∅ 63, ∅ 80, ∅ 100

RoHS

## How to Order



**25A - MGP M 32 - 50 AZ - M9BW**

Series compatible with secondary batteries

Compact guide cylinder

Bearing type

M	Slide bearing
L	Ball bushing

Bore size

16	16 mm
20	20 mm
25	25 mm
32	32 mm
40	40 mm
50	50 mm
63	63 mm
80	80 mm
100	100 mm

Cylinder stroke [mm]

Bore size	Standard stroke
16	25, 50, 75, 100, 125, 150, 175, 200, 250
20 to 63	25, 50, 75, 100, 125, 150, 175, 200, 250, 300, 350, 400
80, 100	50, 75, 100, 125, 150, 175, 200, 250, 300, 350, 400

Port thread type

—	M5 x 0.8
	Rc
TN	NPT
TF	G

\* For bore size 16, only M5 x 0.8 is available.

Number of auto switches

—	2
S	1
n	n

Auto switch

—	Without auto switch (Built-in magnet)
---	---------------------------------------

\* For applicable auto switches, refer to page 207.

With air cushion

\* The 25A- series specifications and dimensions are the same as those of the standard model.

# Slide Unit: Built-in Shock Absorber Slide Bearing Type

## 25A-CXWM Series

∅ 10, ∅ 16, ∅ 20, ∅ 25, ∅ 32

RoHS

### How to Order

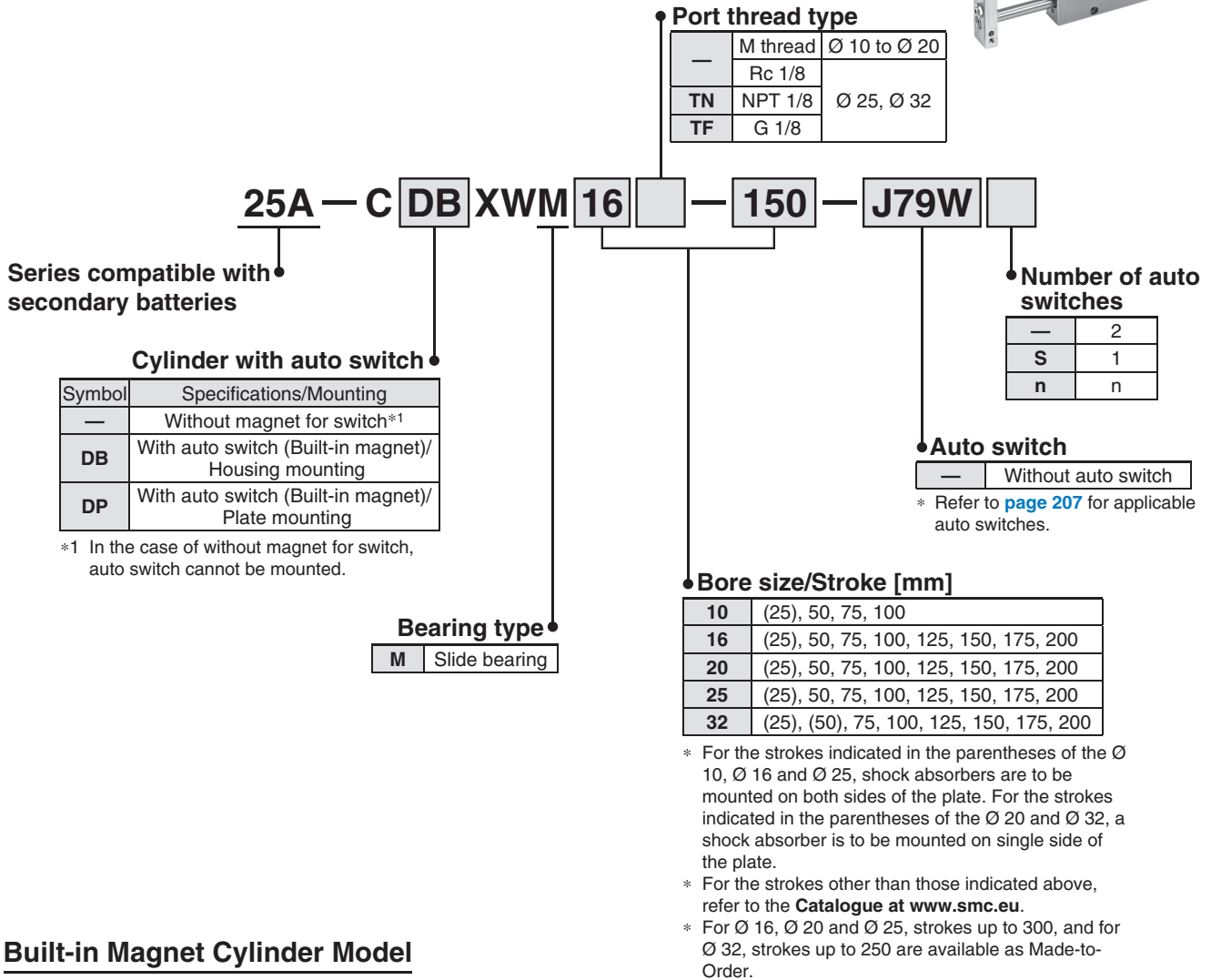

### Built-in Magnet Cylinder Model

If a built-in magnet cylinder without an auto switch is required, there is no need to enter the symbol for the auto switch. (Example) 25A-CDPXWM20-100

\* The 25A- series specifications and dimensions are the same as those of the standard model.

# Dual Rod Cylinder/Compact Type RoHS

## 25A-CXSJ Series

∅ 6, ∅ 10, ∅ 15, ∅ 20, ∅ 25, ∅ 32

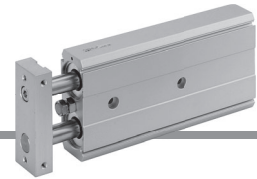

### How to Order

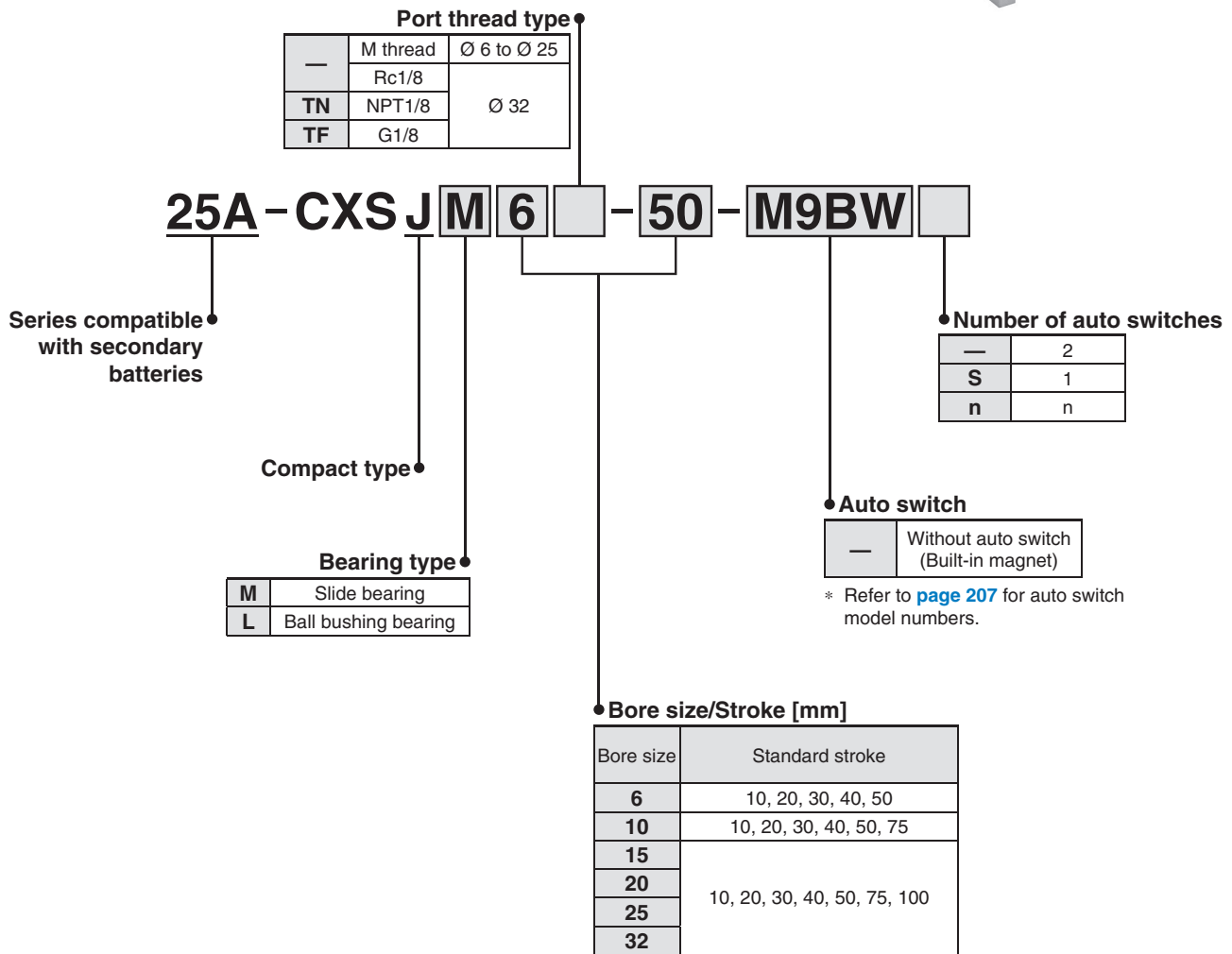

\* The 25A- series specifications and dimensions are the same as those of the standard model.

# Dual Rod Cylinder Basic Type

## 25A-CXS Series

∅ 6, ∅ 10, ∅ 15, ∅ 20, ∅ 25, ∅ 32

RoHS

### How to Order

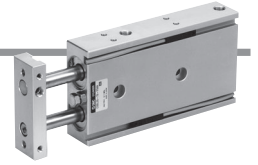

#### Slide bearing type

Series compatible with secondary batteries

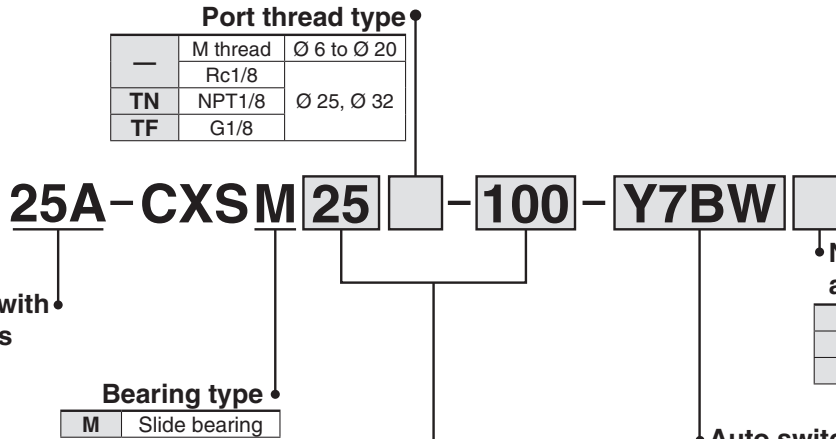

Bore size/Stroke [mm]

Bore size	Standard stroke [mm]
6	10, 20, 30, 40, 50
10	10, 15, 20, 25, 30, 35, 40, 45, 50, 60, 70, 75
15, 20, 25, 32	10, 15, 20, 25, 30, 35, 40, 45, 50, 60, 70, 75, 80, 90, 100

\* Refer to page 207 for applicable auto switches.

\* The 25A- series specifications and dimensions are the same as those of the standard model.

#### Ball bushing bearing type

Series compatible with secondary batteries

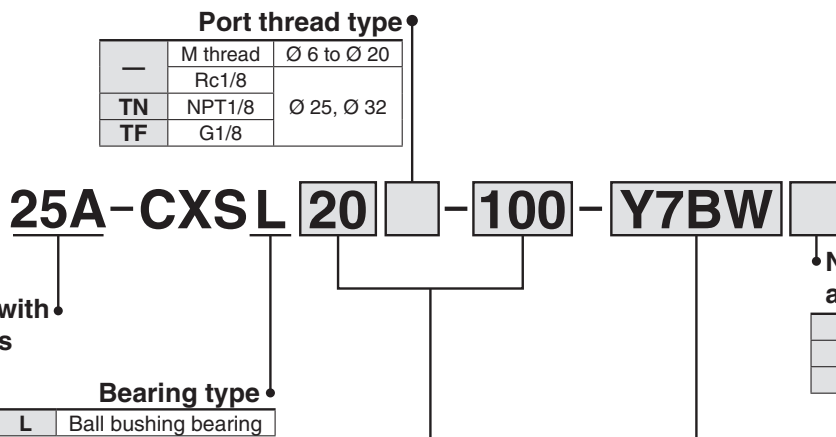

Bore size/Stroke [mm]

Bore size	Standard stroke [mm]
6	10, 20, 30, 40, 50
10	10, 15, 20, 25, 30, 35, 40, 45, 50, 60, 70, 75
15, 20, 25, 32	10, 15, 20, 25, 30, 35, 40, 45, 50, 60, 70, 75, 80, 90, 100

\* Refer to page 207 for applicable auto switches.

\* The 25A- series specifications and dimensions are the same as those of the standard model.

# Guide Cylinder

RoHS

# 25A-MGG Series

∅ 20, ∅ 25, ∅ 32, ∅ 40, ∅ 50

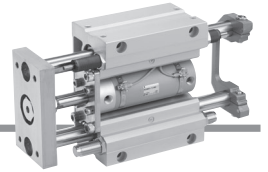

## How to Order

**25A - MGG L B 32**    - **100** - **M9BW**   

Series compatible  
with secondary  
batteries

Guide cylinder

Bearing type

L	Ball bushing
---	--------------

Mounting

B	Basic
F	Front mounting flange

Bore size

20	20 mm
25	25 mm
32	32 mm
40	40 mm
50	50 mm

Port thread type

—	Rc
TN	NPT
TF	G

Number of auto switches

—	2
S	1
n	n

Auto switch

—	Without auto switch (Built-in magnet)
---	--

\* Refer to [page 207](#) for applicable auto switches.

Cylinder stroke [mm]

Bore size [mm]	Standard stroke [mm]	Long stroke [mm]
20	75, 100, 125, 150, 200	250, 300, 350, 400
25		350, 400, 450, 500
32		350, 400, 450, 500, 600
40	75, 100, 125, 150, 200, 250, 300	350, 400, 450, 500, 600, 700, 800
50		350, 400, 450, 500, 600, 700, 800, 900, 1000

\* Intermediate strokes and short strokes other than those listed above are produced upon receipt of order.

\* The 25A- series specifications and dimensions are the same as those of the standard model.



# Rotary Clamp Cylinder: Standard



# 25A-MK Series

Ø 12, Ø 16, Ø 20, Ø 25, Ø 32, Ø 40, Ø 50, Ø 63



## How to Order

**25A - MKB 20**    - **10 R Z - M9BW**   

Series compatible with secondary batteries

### Bore size

12	12 mm
16	16 mm
20	20 mm
25	25 mm
32	32 mm
40	40 mm
50	50 mm
63	63 mm

### Port thread type

—	M thread	Ø 12 to Ø 25
	Rc	
TN	NPT	Ø 32 to Ø 63
TF	G	

### Clamp stroke

Symbol	Clamp stroke	Applicable bore size
10	10 mm	Ø 12 to Ø 63
20	20 mm	
30	30 mm	
50	50 mm	Ø 32 to Ø 63

### Number of auto switches

—	2
S	1

### Auto switch type

—	Without auto switch (Built-in magnet)
---	---------------------------------------

- \* For applicable auto switch models, refer to [page 207](#).
- \* Auto switches are shipped together, but not assembled.

### Auto switch multiple side mounting

### Rotary direction (Unclamp → Clamp)

R	Clockwise
L	Counterclockwise

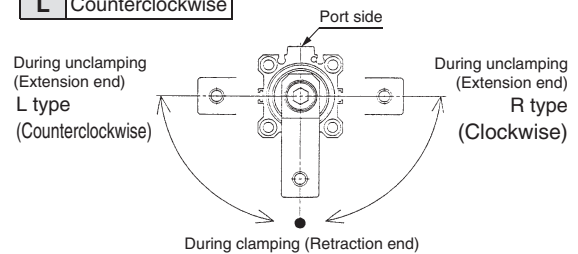

- \* The coil scraper is not built-in.
- \* The 25A- series specifications and dimensions are the same as those of the standard model.

# Stopper Cylinder/Fixed Mounting Height RoHS

## 25A-RSQ Series

Ø 12, Ø 16, Ø 20, Ø 25, Ø 32, Ø 40, Ø 50



### How to Order

	Bore size	Cylinder stroke [mm]			
	12 12 mm	12 10			
Ø 12	<b>25A-RS</b>	<b>D</b>	<b>Q</b>	<b>B</b>	<b>12</b>
		-	<b>10</b>	<b>D</b>	-
				<b>L</b>	-
					<b>M9BW</b>
Ø 16 to Ø 50	<b>25A-RS</b>	<b>D</b>	<b>Q</b>	<b>B</b>	<b>20</b>
					-
				<b>15</b>	<b>D</b>
					-
				<b>Z</b>	-
					<b>L</b>
					-
					<b>M9BW</b>

**Series compatible with secondary batteries**

**With auto switch**

—	Without magnet for switch*1
D	With auto switch (Built-in magnet)

\*1 In the case of without magnet for switch, auto switch cannot be mounted.

**Mounting bracket**

B	Through-hole
A	Both ends tapped type

\* Since Ø 12 uses a common tube for both A and B, only B is used for part no. denotation.

**Port thread type**

—	M thread	Ø 16
	Rc	
TN	NPT	Ø 20 to Ø 50
TF*1	G	

\*1 TF for Ø 20 indicates M5.

**Bore size**

16	16 mm
20	20 mm
32	32 mm
40	40 mm
50	50 mm

**Rod end configuration**

—	Round bar
F*1	Round bar with female rod end
K	Chamfered
G*1	Chamfered with female rod end
R	Roller
L*2	Lever (Fixed absorber type)

\*1 F and G are not available for bore size Ø 12.  
\*2 L is applicable only to bore sizes Ø 32, Ø 40, and Ø 50.

**Cylinder stroke [mm]**

16	10, 15
20	10, 15, 20
32	10, 15, 20
40	20, 25, 30
50	20, 25, 30

**Action**

D	Double acting
B	Double acting with spring loaded
T	Single acting (Spring extend)

**Mounting bolt**

—	None
L	Shipped together

\* Mounting bolt is shipped together only when the "Mounting" symbol is B.

**Auto switch type**

—	Without auto switch
---	---------------------

\* For applicable auto switch models, refer to [page 207](#).

**Number of auto switches**

—	2
S	1

\* The 25A- series specifications and dimensions are the same as those of the standard model.

# Heavy Duty Stopper Cylinder

## 25A-RSH Series

∅ 20, ∅ 32

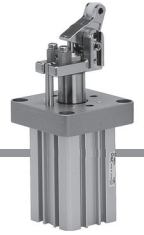

### How to Order

**25A-RSH 32**    - **20 D L** - **M9BW**   

Series compatible with secondary batteries

Bore size

20	20 mm
32	32 mm

Port thread type

—	M*1
	Rc
TN	NPT
TF	G

\*1 The tube I.D. of 20 is only available to port size M screws.

Cylinder stroke

15	15 mm (RSH20)
20	20 mm (RSH32)

Number of auto switches

—	2
S	1

Auto switch

—	Without auto switch (Built-in magnet)
---	---------------------------------------

\* For applicable auto switches, refer to [page 207](#).

Roller material

L	Resin
M	Carbon steel

Action

D	Double acting type
B	Double acting spring type
T	Single acting/Spring extended

\* The 25A- series specifications and dimensions are the same as those of the standard model.

# Shock Absorber Soft Type



# 25A-RJ Series

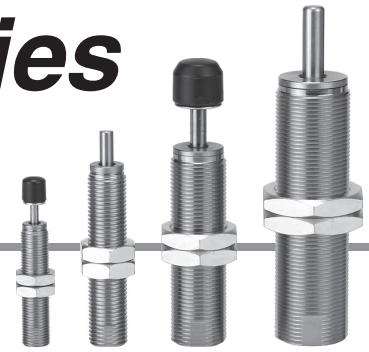

## How to Order

**25A - RJ 0604**

**25A - RJ 0806 H U**

Series compatible with secondary batteries

Shock absorber/Soft type

O.D. thread size/Stroke

Symbol	O.D. thread	Stroke
0604	6 mm	4 mm
0806	8 mm	6 mm
1007	10 mm	7 mm
1412	14 mm	12 mm
2015	20 mm	15 mm
2725	27 mm	25 mm

Option

Symbol	Hexagon nut	Stopper nut
—	2 pcs.	—
J	3 pcs.	—
N	—	—
S	2 pcs.	1 pc.
SJ	3 pcs.	1 pc.
SN	—	1 pc.

With cap

—	Basic type
U	With urethane cap

Collision speed range

H	0.05 to 2 m/s
L	0.05 to 1 m/s

\* RJ0604: 0.05 to 1.0 m/s

\* RJ2725H: 0.05 to 1.5 m/s

## Hexagon Nut, Stopper Nut (Option) Part Nos. for the 25A- Series

		Thread size				
		M8	M10	M14	M20	M27
Hexagon nut		25-RB08J	25-RB10J	25-RB14J	25-RB20J	25-RB27J
Stopper nut	Basic type	25-RB08S	25-RB10S	25-RB14S	25-RB20S	25-RB27S
	With cap	25-RBC08S	25-RBC10S	25-RBC14S	25-RBC20S	25-RBC27S

Material: Special steel  
Treatment: Electroless nickel plating

\* The 25A- series specifications and dimensions are the same as those of the standard model.

# Shock Absorber Short Stroke Type



# 25A-RJ Series

## How to Order

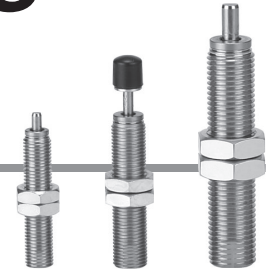

Short stroke type

**25A - RJ 0805 U**

Series compatible with secondary batteries

Shock absorber/Soft type

O.D. thread size/Stroke

Symbol	O.D. thread	Stroke
0805	8 mm	5 mm
1006	10 mm	6 mm
1410	14 mm	10 mm

Option

Symbol	Hexagon nut	Stopper nut
—	2 pcs.	—
J	3 pcs.	—
N	—	—
S	2 pcs.	1 pc.
SJ	3 pcs.	1 pc.
SN	—	1 pc.

With cap

—	Basic type
U	With urethane cap

## Hexagon Nut, Stopper Nut (Option) Part Nos. for the 25A- Series

	Thread size			
	M8	M10	M14	
Hexagon nut	25-RB08J	25-RB10J	25-RB14J	
Stopper nut	Basic type	25-RB08S	25-RB10S	25-RB14S
	With cap	25-RBC08S	25-RBC10S	25-RBC14S

Material: Special steel  
Treatment: Electroless nickel plating

\* The 25A- series specifications and dimensions are the same as those of the standard model.

# Shock Absorber 25A-RB/RBC Series

## How to Order

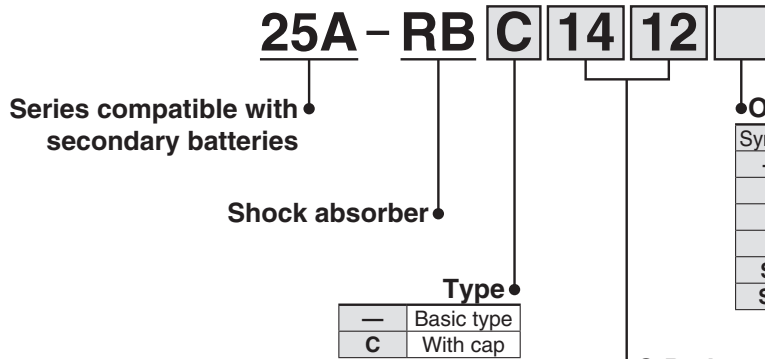

•Option

Symbol	Hexagon nut	Stopper nut
—	2 pcs.	—
J	3 pcs.	—
N	—	—
S	2 pcs.	1 pc.
SJ	3 pcs.	1 pc.
SN	—	1 pc.

•O.D. thread size/Stroke

Symbol	O.D. thread size	Stroke	Symbol	O.D. thread size	Stroke
0805	8 mm	5 mm	1411	14 mm	11 mm
0806	8 mm	6 mm	1412	14 mm	12 mm
1006	10 mm	6 mm	2015	20 mm	15 mm
1007	10 mm	7 mm	2725	27 mm	25 mm

### Hexagon Nut, Stopper Nut (Option) Part Nos. for the 25A- Series

		Thread size				
		M8	M10	M14	M20	M27
Hexagon nut		25-RB08J	25-RB10J	25-RB14J	25-RB20J	25-RB27J
Stopper nut	Basic type	25-RB08S	25-RB10S	25-RB14S	25-RB20S	25-RB27S
	With cap	25-RBC08S	25-RBC10S	25-RBC14S	25-RBC20S	25-RBC27S

Material: Special steel  
Treatment: Electroless nickel plating

\* The 25A- series specifications and dimensions are the same as those of the standard model.

# Floating Joint 25A-J□ Series



## How to Order

### Standard type

**25A - JA 80 - 22-150**

Series compatible with secondary batteries

Applicable bore size [mm]

Model	Symbol	Applicable bore size [mm]
Standard	80	80
	100	100

\* For Ø 63 or less, please consider using the stainless steel type 25A-JS series.

Thread nominal size (Standard)

Nominal thread size	Applicable cylinder nominal thread size
22-150	M22 x 1.5
26-150	M26 x 1.5

\* The 25A- series specifications and dimensions are the same as those of the standard model.



## How to Order

### For compact cylinders

**25A - J B 40 - 8-125**

Series compatible with secondary batteries

For compact cylinders/Female thread

Applicable bore size [mm]

Symbol	Applicable bore size [mm]
12	12
16	16
20	20
25	25
40	32, 40
63	50, 63
80	80
100	100

Thread nominal size

Nominal thread size	Applicable cylinder nominal thread size
3-050	M3 x 0.5
4-070	M4 x 0.7
5-080	M5 x 0.8
6-100	M6 x 1
8-125	M8 x 1.25
10-150	M10 x 1.5
16-200	M16 x 2
20-250	M20 x 2.5

\* The 25A- series specifications and dimensions are the same as those of the standard model.



## How to Order

### Stainless steel type

**25A - J S 32 - 10-125**

Series compatible with secondary batteries

Stainless steel type

Applicable bore size [mm]

Symbol	Applicable bore size [mm]
10	10
16	10, 16
20	20
32	25, 32
40	40
63	50, 63

Thread nominal size

Nominal thread size	Applicable cylinder nominal thread size
4-070	M4 x 0.7
5-080	M5 x 0.8
8-125	M8 x 1.25
10-125	M10 x 1.25
14-150	M14 x 1.5
18-150	M18 x 1.5

\* The 25A- series specifications and dimensions are the same as those of the standard model.





# Rotary Table: Vane Type

# 25A-MSUB Series

Size: 1, 3, 7, 20

RoHS

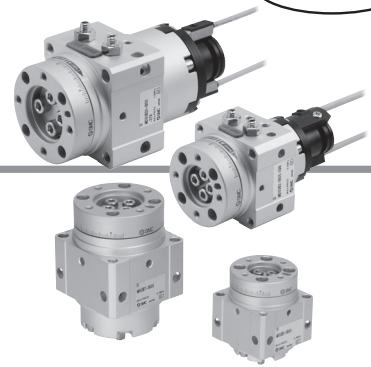

## How to Order

**Without auto switch** 25A-M SUB 20-90 S

**With auto switch** 25A-M D SUB 20-90 S-T79 L

**Series compatible with secondary batteries**

**With auto switch (Built-in magnet)**

**Nominal size (Torque)**

1	MSUB 1
3	MSUB 3
7	MSUB 7
20	MSUB20

**Rotating angle**

Application	Symbol	Rotating angle
Single vane	90	90°
	180	180°
Double vane	90	90°

Rotation adjustment range  
 Single vane: Both ends ±5° each  
 Double vane: Both ends ±2.5° each

**Connection port location**

—	Side ported
E	Axial ported

Available with side ported only, when equipped with auto switch unit.

**Number of auto switches**

S	1*1
—	2*2

\*1 S (1 auto switch) is shipped with a right-hand auto switch.  
 \*2 — (2 auto switches) is shipped with a right-hand and a left-hand switch.

**Electrical entry/Lead wire length**

—	Grommet/Lead wire: 0.5 m
L	Grommet/Lead wire: 3 m

**Auto switch**

—	Without auto switch (Built-in magnet)
---	---------------------------------------

\* Refer to page 209 for applicable auto switches.

**Vane type**

S	Single vane
D	Double vane

\* The 25A- series specifications and dimensions are the same as those of the standard model.  
 \* Zinc is used in part of deep groove ball bearing.

# Rotary Table/Rack & Pinion Type

# 25A-MSQ Series

Size: 10, 20, 30, 50, 70, 100, 200

RoHS

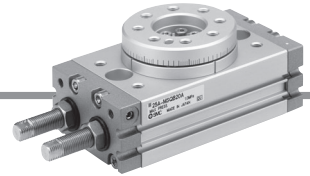

## How to Order

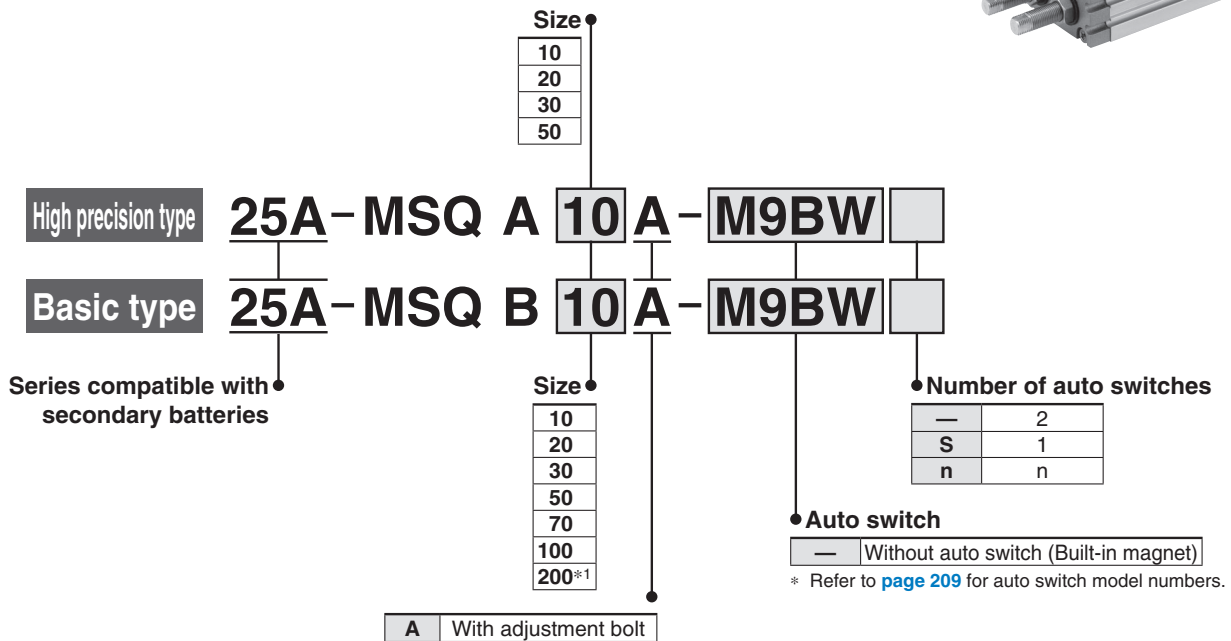

- \* Zinc is used in part of deep groove ball bearing and seal washer.
- \* Side port cannot be used.
- \*1 Size 200 are produced upon receipt of order.

\* Some parts have sizes and shapes that are different from the standard products.

## With Vacuum Port

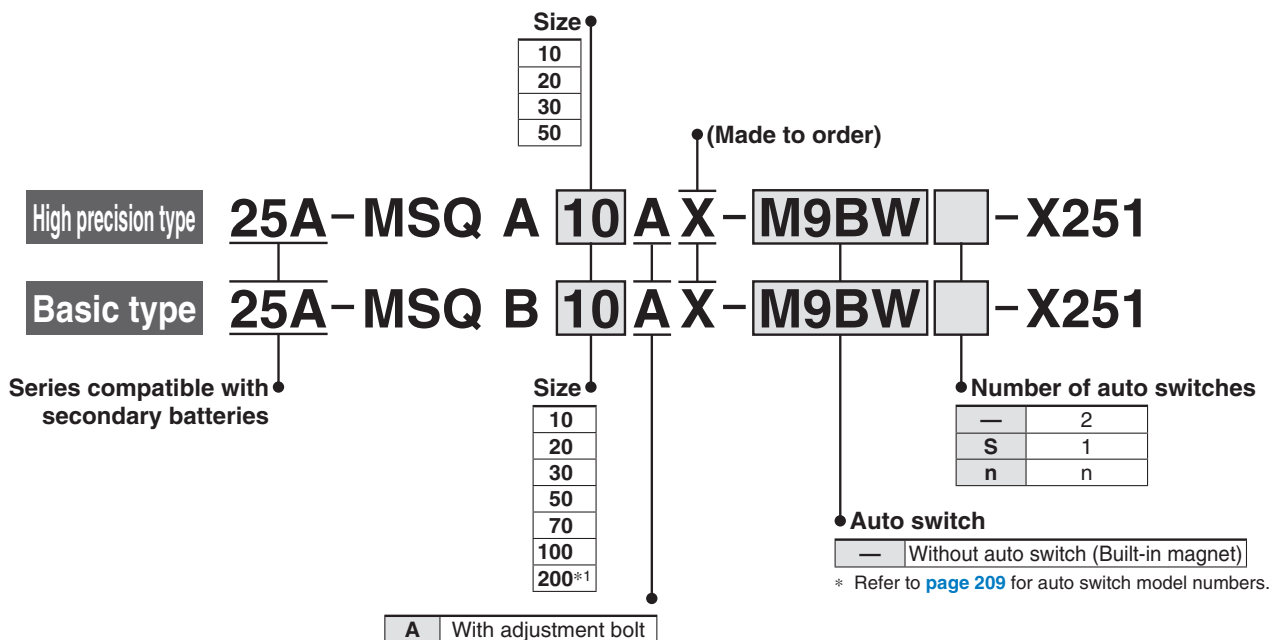

- \* Zinc is used in part of deep groove ball bearing and seal washer.
- \* Side port cannot be used.
- \*1 Size 200 are produced upon receipt of order.

\* Some parts have sizes and shapes that are different from the standard products.

# 25A-MSQ Series

## Dimensions

### 25A-MSQB□A

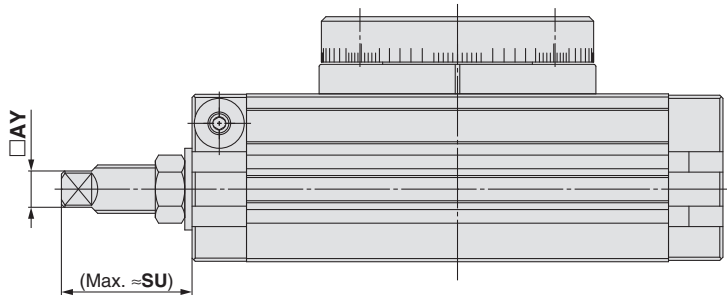

Size	AY	SU
10	6	23.7
20	8	33
30	8	33
50	10	42.9
70	16	44.2
100	16	44.3
200	21	52.2

\* Dimensions other than those shown above are identical to the standard products.

### 25A-MSQB□AX-X251

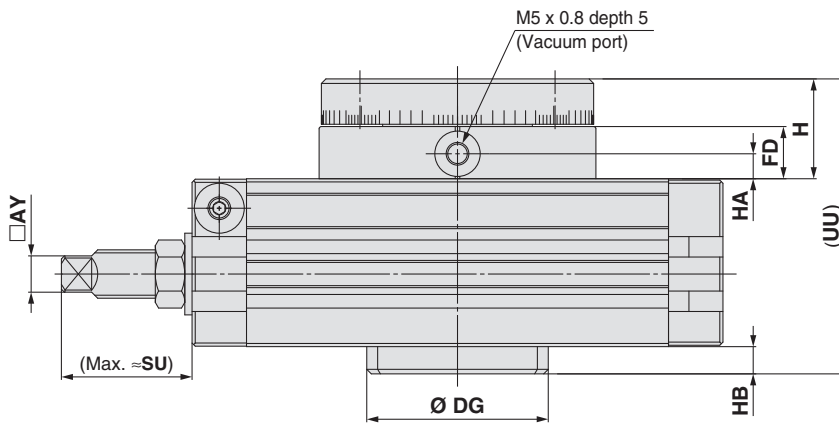

Size	AY	DG	FD	H	HA	HB	SU	UU
10	6	35h9	11.5	20	5.5	5	23.7	59
20	8	40h9	11.5	22	5.5	6	33	65
30	8	48h9	11.5	22	5.5	6	33	68
50	10	54h9	11.5	24	5.5	7	42.9	77
70	16	50h9	12	25	6	7	44.2	85
100	16	52h9	12	27	6	7	44.3	93
200	21	64h9	15	32	7.5	8	52.2	114

\* The product with the vacuum port has no hollow shaft at its rotation centre.  
 \* Dimensions other than those shown above are identical to the standard products.

# 3-Position Rotary Table

# 25A-MSZ Series

Size: 10, 20, 30, 50

RoHS



## How to Order

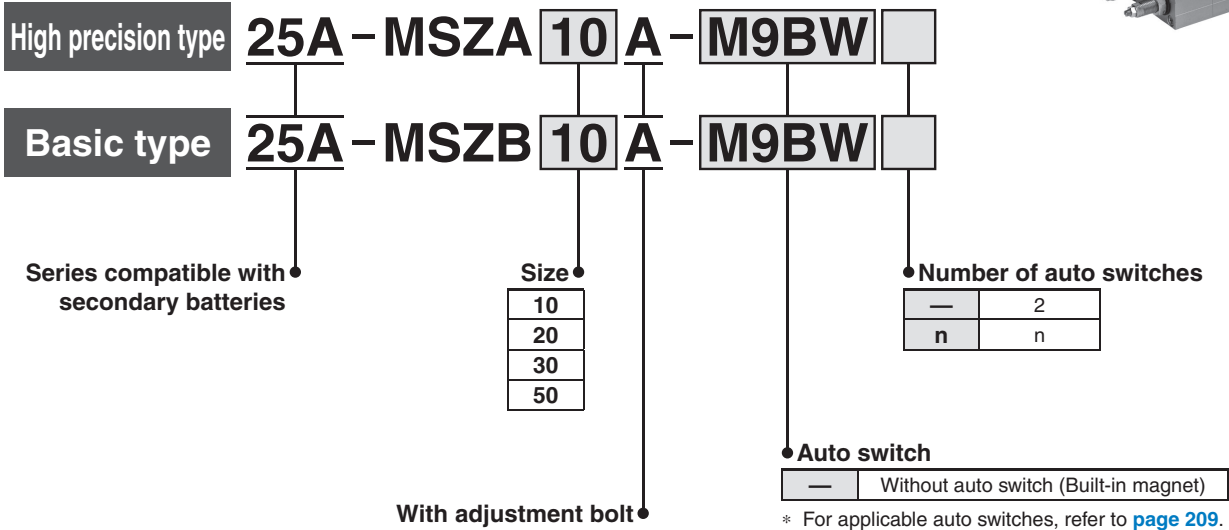

\* The 25A- series specifications and dimensions are the same as those of the standard model.

# Parallel Type Air Gripper Standard Type

# 25A-MHZ2 Series

∅ 10, ∅ 16, ∅ 20, ∅ 25, ∅ 32, ∅ 40

RoHS

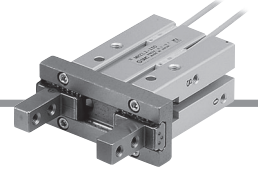

## How to Order

### Bore size

∅ 16 to ∅ 25

25A-MHZ2-16 D [ ] -M9BW [ ]

Series compatible with secondary batteries

Number of fingers

2	2 fingers
---	-----------

Bore size

10	10 mm
16	16 mm
20	20 mm
25	25 mm

Action

D	Double acting
---	---------------

Number of auto switches

—	2
S	1
n	n

Auto switch

—	Without auto switch (Built-in magnet)
---	---------------------------------------

\* Refer to page 210 for the applicable auto switch model.

Finger position/option

**Standard**  
(MHQG2 compatible type)

—: Basic type

1: Side tapped mounting

2: Through-holes in opening/closing direction

3: Flat type fingers

The flat type fingers do not have standard and narrow options.

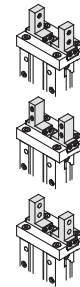

**Narrow type**  
(MHQ2 compatible type)

N: Basic type

N1: Side tapped mounting

N2: Through-holes in opening/closing direction

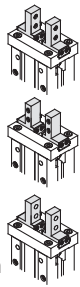

### Bore size

∅ 32, ∅ 40

25A-MHZ2-32 D [ ] -M9BW [ ]

Series compatible with secondary batteries

Number of fingers

2	2 fingers
---	-----------

Bore size

32	32 mm
40	40 mm

Action

D	Double acting
---	---------------

Number of auto switches

—	2
S	1
n	n

Auto switch

—	Without auto switch (Built-in magnet)
---	---------------------------------------

\* Refer to page 210 for the applicable auto switch model.

Finger option

**[Standard]**

—: Basic type

1: Side tapped mounting

2: Through-holes in opening/closing direction

3: Flat type fingers



\* The 25A- series specifications and dimensions are the same as those of the standard model.

# Parallel Type Air Gripper Long Stroke Type **25A-MHZL2 Series**



## How to Order

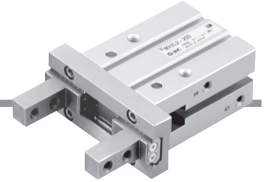

**25A - MHZL2 - 16 D**   - **M9BW**  

Series compatible with secondary batteries

Number of fingers  
2 2 fingers

**Bore size**

Symbol	Bore size [mm]
<b>10</b>	10 mm
<b>16</b>	16 mm
<b>20</b>	20 mm
<b>25</b>	25 mm

**Action**  
D Double acting

Number of auto switches

—	2
<b>S</b>	1
<b>n</b>	n

**Auto switch**

— Without auto switch (Built-in magnet)

\* Refer to [page 210](#) for the applicable auto switch model.

**Finger option**

—: Basic type

1: Side tapped mounting

2: Through-holes in opening/closing direction

3: Flat type fingers



\* The 25A- series specifications and dimensions are the same as those of the standard model.

# 25A-MHZJ2 Series



## 25A-MHZJ2-X6100 (Made to Order)

Parallel Type Air Gripper with Dust Cover: Long Stroke Type

## 25A-MHZL2-X5955 (Made to Order)

### How to Order



#### With Dust Cover

**Series compatible with secondary batteries**

**Ø 10 to Ø 25**  
**Ø 32, Ø 40**  
**Made to Order**

**25A - MHZJ2 - 16 D [ ] - M9BW [ ]**  
**25A - MHZJ2 - 32 D [ ] - M9BW [ ] - X6100**

**Bore size**

10	10 mm
16	16 mm
20	20 mm
25	25 mm

**Number of fingers**

2	2 fingers
---	-----------

**Bore size**

32	32 mm
40	40 mm

**Action**

D	Double acting
---	---------------

**Dust cover type**

—	Chloroprene rubber (CR)
F	Fluororubber (FKM)
S	Silicone rubber (Si)

**Auto switch**

—	Without auto switch (Built-in magnet)
---	---------------------------------------

**Number of auto switches**

—	2
S	1
n	n

\* Refer to [page 210](#) for the applicable auto switch model.

\* Sizes Ø 10 to Ø 25 of the 25A- series have the same specifications and dimensions as those of the standard model.

\* Sizes Ø 32 and Ø 40 of the 25A- series have the same specifications and dimensions as those of the MHZJ2-X6100 (made-to-order individual specifications).

#### Long Stroke Type/ With Dust Cover (Made to Order)

**25A - MHZL2 - 16 D [ ] - M9BW [ ] - X5955**

**Series compatible with secondary batteries**

**Number of fingers**

2	2 fingers
---	-----------

**Bore size/Stroke**

Symbol	Bore size [mm]
10	10 mm
16	16 mm
20	20 mm

**Action**

D	Double acting
---	---------------

**Dust cover type**

—	Chloroprene rubber (CR)
F	Fluororubber (FKM)
S	Silicone rubber (Si)

**Auto switch**

—	Without auto switch (Built-in magnet)
---	---------------------------------------

**Number of auto switches**

—	2
S	1
n	n

\* Refer to [page 210](#) for the applicable auto switch model.

\* The 25A- specifications and dimensions are the same as those of the MHZL2-X6110 (made to order individual specifications).



# Low Profile Air Gripper

## 25A-MHF2 Series



### How to Order



**25A-MHF 2 - 12 D [ ] [ ] - M9BW [ ]**

Number of fingers  

2	2 fingers
---	-----------

- Series compatible with secondary batteries

Bore size [mm]

8	8
12	12
16	16
20	20

Action  
**D** Double acting

Stroke

—	Short stroke
1	Medium stroke
2	Long stroke

Number of auto switches

—	2
S	1
n	n

Auto switch  
 — Without auto switch (Built-in magnet)

\* Refer to [page 210](#) for the applicable auto switch model.

Body option

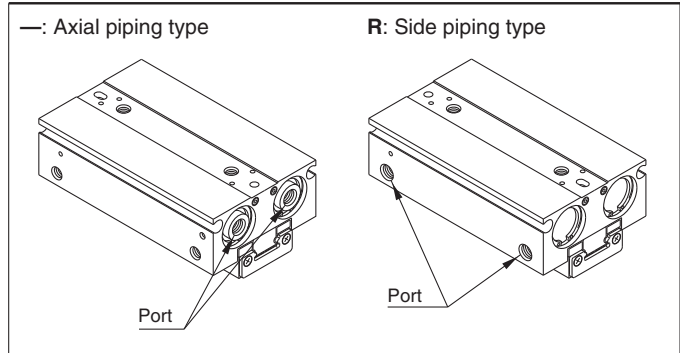

\* The 25A- series specifications and dimensions are the same as those of the standard model.

# Parallel Type Air Gripper: Wide Type

# 25A-MHL2 Series

∅ 10, ∅ 16, ∅ 20, ∅ 25, ∅ 32, ∅ 40

RoHS

## How to Order

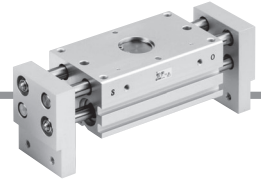

**25A-MHL2-20D**  - **M9BW**

Series compatible with secondary batteries

Wide opening

Number of fingers

**2** 2 fingers

Bore size

10	10 mm
16	16 mm
20	20 mm
25	25 mm
32	32 mm
40	40 mm

Action

**D** Double acting

Number of auto switches

—	2
S	1
n	n

Auto switch

— Without auto switch (Built-in magnet)

\* Refer to [page 210](#) for the applicable auto switch model.

Opening/Closing stroke [mm]

Symbol	∅ 10	∅ 16	∅ 20	∅ 25	∅ 32	∅ 40
—	20	30	40	50	70	100
1	40	60	80	100	120	160
2	60	80	100	120	160	200

\* The 25A- series specifications and dimensions are the same as those of the standard model. (Weight is not the same.)

# Parallel Type Air Gripper

## 25A-MHS□ Series

∅ 16, ∅ 20, ∅ 25, ∅ 32

RoHS

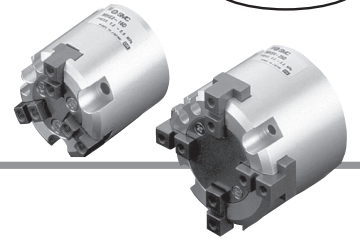

### How to Order

25A - MHS 3 - 20 D - M9BW □

Series compatible with secondary batteries

Number of fingers

3	3 fingers
4	4 fingers

Bore size

16	16 mm
20	20 mm
25	25 mm
32	32 mm

Action

D	Double acting
---	---------------

Number of auto switches

—	2
S	1

Auto switch

—	Without auto switch (Built-in magnet)
---	---------------------------------------

\* Refer to [page 210](#) for the applicable auto switch model.

\* The 25A- series specifications and dimensions are the same as those of the standard model.

# Parallel Type Air Gripper 3-Finger Type with Dust Cover

## 25A-MHSJ3 Series

∅ 16, ∅ 20, ∅ 25, ∅ 32

RoHS



### How to Order

**25A - MHSJ 3 - 20 D - M9BW**

- Series compatible with secondary batteries**
- With dust cover**
- Number of fingers**  
3 | 3 fingers
- Bore size**

16	16 mm
20	20 mm
25	25 mm
32	32 mm
- Action**  
D | Double acting
- Dust cover type**

—	Chloroprene rubber (CR)
F	Fluororubber (FKM)
S	Silicon rubber (Si)
- Auto switch**  
— | Without auto switch (Built-in magnet)  
\* Refer to [page 210](#) for the applicable auto switch model.
- Number of auto switches**

—	2
S	1

\* The 25A- series specifications and dimensions are the same as those of the standard model.

# 180° Angular Type Air Gripper Cam Type

# 25A-MHY2 Series

∅ 10, ∅ 16, ∅ 20, ∅ 25

RoHS



## How to Order

25A - MHY 2 - 16 D 2 - M9BW

Series compatible with secondary batteries

Number of fingers

2 2 fingers

Bore size

10	10 mm
16	16 mm
20	20 mm
25	25 mm

Action

D Double acting

Number of auto switches

—	2
S	1
n	n

Auto switch

— Without auto switch (Built-in magnet)

\* Refer to [page 210](#) for the applicable auto switch model.

Finger option

—: Standard tapped mounting

2: Through-holes in opening/closing direction

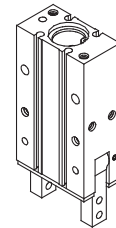
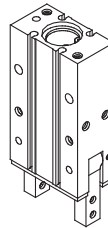

\* The 25A- series specifications and dimensions are the same as those of the standard model.

# 180° Angular Type Air Gripper Rack & Pinion Type

## 25A-MHW2 Series

Ø 20, Ø 25, Ø 32, Ø 40, Ø 50

### How to Order

**25A-MHW2-20** **D** **1** - **M9BW**

**Series compatible with secondary batteries**

**Number of fingers**  
2 | 2 fingers

**Bore size**

20	20 mm
25	25 mm
32	32 mm
40	40 mm
50	50 mm

**Port thread type**

Symbol	Type	Size
—	M thread	Ø 20, Ø 25
	Rc	Ø 32
TN	NPT	Ø 40
TF	G	Ø 50

**Action**  
D | Double acting

**Number of auto switches**

—	2
S	1
N	n

**Auto switch**  
— | Without auto switch (Built-in magnet)  
\* Refer to [page 210](#) for the applicable auto switch model.

**Finger option**

—: Flat type fingers (Standard)      1: Right angle type fingers tapped mounting

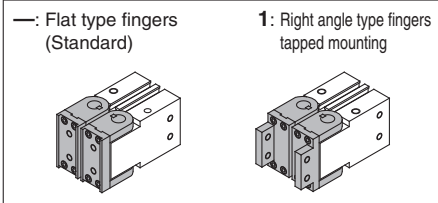

- \* Change of material and surface treatment are not available for the bearing or the parallel key.
- \* As metal-to-metal collision occurs when the fingers are fully closed, dust particles may be generated.

\* The 25A- series specifications and dimensions are the same as those of the standard model.

# Ejector System Vacuum Unit

# 25A-ZK2□A Series



Single Unit Ejector + With Valve + Without Energy Saving Function

## How to Order

25A-ZK2 **A** **12** **K** **5** **A** **L** **A** - **08** - □

1
2
3
4
5
6
7
8

### 1 Body/Exhaust type

Symbol	Body	Exhaust type
A	Single unit	Silencer exhaust*1 
		Port exhaust 
B	Single unit	High-noise reduction silencer exhaust 
G	Single unit	High-noise reduction silencer exhaust 

\*1 With exhaust port when 2 is 12 or 15

### 4 Rated voltage (Supply valve/Release valve)

Symbol	Voltage
5	24 VDC
6	12 VDC

### 5 Pressure switch for vacuum/Pressure sensor

Symbol	Type	Pressure range [kPa]	Specifications		
			NPN 2 outputs	PNP	With unit selection function*3
A	Pressure switch for vacuum	0 to -101	●	—	●
B			●	—	None (SI unit only)
C			—	●	●
D		-100 to 100	—	●	None (SI unit only)
E			●	—	●
F			●	—	None (SI unit only)
H	—	●	●		
J	—	●	●	None (SI unit only)	
P	Pressure sensor	0 to -101	Analogue output 1 to 5 V		
T		-100 to 100			
N	Without pressure switch for vacuum/pressure sensor				

\*3 The unit selection function is not available in Japan due to the New Measurement Law. The unit for the type without the unit selection function is fixed as kPa.

### 7 Vacuum (V) port

Symbol	Vacuum (V) port
06	Ø 6
08	Ø 8

Manifold type is not available.

### 2 Nominal nozzle size

Symbol	Nominal nozzle size
07	Ø 0.7
10	Ø 1.0
12	Ø 1.2
15	Ø 1.5

\* The standard supply pressure of each nozzle diameter is the same as that of the corresponding standard product.

### 3 Combination of supply valve and release valve

Symbol	Supply valve		Release valve
	N.C.	Self-holding	N.C.
K	●	—	●
J	●	—	—
R	—	●*2	●

\*2 Supply valve maintains vacuum by energisation (20 ms or more). Stopping the vacuum turns on the release valve.

### 6 Connector (Supply valve/Release valve/Pressure switch for vacuum)

Symbol	For supply valve/ release valve: 300 mm (Connector assembly)*4	For pressure switch for vacuum: 2 m (Lead wire with connector)	Pressure sensor assembly: 3 m (With lead wire)	Note
L	●	—	●	Cannot be selected when 5 is N
L1	None	—	●	
L2	●	—	None	Cannot be selected when 5 is P or T
L3	None	—	None	

\*4 For the connector length other than 300 mm, order the connector assembly on page 140-5 separately.

### 8 Option\*5 (For details on the Function/Application, refer to page 140-6.)

Symbol	Type	Note
—	Without option	—
B	Mounting bracket for single unit (nuts and bolts are included) 	—
D	With individual release pressure supply (PD) port (M3)*6 	Cannot be selected when 3 is J
E	Vacuum break flow adjusting needle Screwdriver operation type long lock nut 	Cannot be selected when 3 is J
J	Round lock nut Lock nut 	
K	Vacuum break flow adjusting needle Screwdriver operation type 	Can be selected only for the combination of J and K
W	With exhaust interference prevention valve 	When J is selected for 8, install the release valve or vacuum breaker in the middle of the vacuum piping.

\*5 When more than one option is selected, list the option symbols in alphabetical order. (Example -BJ)

\*6 Use a One-touch fitting or barb fitting for piping. (O.D.: Within Ø 6.2)

\* The 25A- series specifications and dimensions are the same as those of the standard model.



# Ejector System Vacuum Unit

# 25A-ZK2□A Series



RoHS

Single Unit Ejector + With Valve + With Energy Saving Function

## How to Order

25A-ZK2 **A** **12** **K** **5** **K** **W** **A** - **08** - □

①
②
③
④
⑤
⑥
⑦
⑧

### ① Body/Exhaust type

Symbol	Body	Exhaust type
A	Single unit	Silencer exhaust*1
		Port exhaust
G	Single unit	High-noise reduction silencer exhaust

\*1 With exhaust port when ② is 12 or 15

### ② Nominal nozzle size

Symbol	Nominal nozzle size
07	∅ 0.7
10	∅ 1.0
12	∅ 1.2
15	∅ 1.5

\* The standard supply pressure of each nozzle diameter is the same as that of the corresponding standard product.

### ③ Combination of supply valve and release valve

Symbol	Supply valve	Release valve
	K	●

### ④ Rated voltage (Supply valve/Release valve)

Symbol	Voltage
5	24 VDC
6	12 VDC

### ⑤ Pressure switch for vacuum with energy saving function

Symbol	Pressure range [kPa]	Specifications		
		NPN	PNP	With unit selection function*2
K	-100 to 100	●	—	●
Q		●	—	None (SI unit only)
R		—	●	●
S		—	●	None (SI unit only)

\*2 The unit selection function is not available in Japan due to the New Measurement Law. The unit for the type without the unit selection function is fixed as kPa.

### ⑥ Connector

Symbol	For pressure switch for vacuum with energy saving function: 2 m (Lead wire with connector)
W	●
L3	None

### ⑦ Vacuum (V) port

Symbol	Vacuum (V) port
06	∅ 6
08	∅ 8

### ⑧ Option\*3 (For details on the Function/Application, refer to page 140-6.)

Symbol	Type	Note
—	Without option	—
B	Mounting bracket for single unit (nuts and bolts are included)	—
D	With individual release pressure supply (PD) port (M3)*4	—
E	Screwdriver operation type long lock nut	Can be selected only for the combination of J and K
J	Round lock nut	
K	Screwdriver operation type vacuum break flow adjusting needle	

\*3 When more than one option is selected, list the option symbols in alphabetical order. (Example -BJ)

\*4 Use a One-touch fitting or barb fitting for piping. (O.D.: Within ∅ 6.2)

Manifold type is not available.

\* The 25A-series specifications and dimensions are the same as those of the standard model.

# Ejector System Vacuum Unit

# 25A-ZK2□A Series



RoHS

Single Unit Ejector + Without Valve + Without Energy Saving Function

## How to Order

25A-ZK2 **A** **12** **N** **0** **N** **N** **A** - **08** - □

①
②
③
④
⑤
⑥

### ① Body/Exhaust type

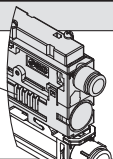
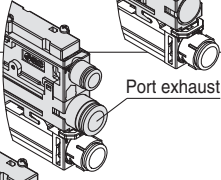
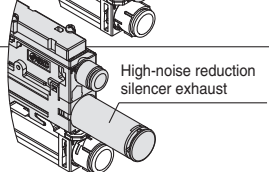
Symbol	Body	Exhaust type
<b>A</b>	Single unit	Silencer exhaust* <sup>1</sup> 
<b>B</b>		Port exhaust 
<b>G</b>		High-noise reduction silencer exhaust 

\*1 With exhaust port when ② is 12 or 15

### ② Nominal nozzle size

Symbol	Nominal nozzle size
<b>07</b>	∅ 0.7
<b>10</b>	∅ 1.0
<b>12</b>	∅ 1.2
<b>15</b>	∅ 1.5

\* The standard supply pressure of each nozzle diameter is the same as that of the corresponding standard product.

### ④ Connector

Symbol	For pressure switch for vacuum: 2 m (Lead wire with connector)	Pressure sensor assembly: 3 m (With lead wire)	Note
<b>Y</b>	●		Cannot be selected when ③ is N
<b>Y1</b>	None		Cannot be selected when ③ is P, T, or N
<b>N</b>	None		When "N" is selected for ③

### ③ Pressure switch for vacuum/Pressure sensor

Symbol	Type	Pressure range [kPa]	Specifications		
			NPN 2 outputs	PNP	With unit selection function* <sup>2</sup>
<b>A</b>	Pressure switch for vacuum	0 to -101	●	—	●
<b>B</b>			●	—	None (SI unit only)
<b>C</b>			—	●	●
<b>D</b>			—	●	None (SI unit only)
<b>E</b>			●	—	●
<b>F</b>	Pressure sensor	-100 to 100	●	—	None (SI unit only)
<b>H</b>			—	●	●
<b>J</b>			—	●	None (SI unit only)
<b>P</b>			0 to -101	Analogue output 1 to 5 V	
<b>T</b>	-100 to 100				
<b>N</b>	Without pressure switch for vacuum/pressure sensor				

\*2 The unit selection function is not available in Japan due to the New Measurement Law. The unit for the type without the unit selection function is fixed as kPa.

### ⑤ Vacuum (V) port

Symbol	Vacuum (V) port
<b>06</b>	∅ 6
<b>08</b>	∅ 8

### ⑥ Option\*<sup>3</sup> (For details on the Function/Application, refer to page 140-6.)

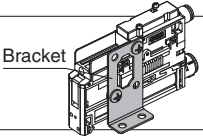
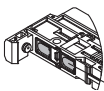
Symbol	Type	Note
—	Without option	—
<b>B</b>	Mounting bracket for single unit (nuts and bolts are included) 	—
<b>W</b>	With exhaust interference prevention valve 	Install the release valve or vacuum breaker in the middle of the vacuum piping.

\*3 When more than one option is selected, list the option symbols in alphabetical order. (Example -BW)

Manifold type is not available.

\* The 25A- series specifications and dimensions are the same as those of the standard model.

# 25A-ZK2□A Series

## Replacement Parts for Single Unit / How to Order

### Valve assembly

25A-ZK2 - VA **A** **K** **5** **L** A - A

① ② ③ ④

① **Applicable system**  
**A** Ejector system

② **Valve type**

<b>K</b>	Supply valve: N.C., Release valve: N.C.
<b>R</b>	Supply valve: Self-holding release valve linked, Release valve: N.C.
<b>J</b>	Supply valve: N.C., Release valve: None

③ **Rated voltage**

<b>5</b>	24 VDC
<b>6</b>	12 VDC

### ④ Wiring

<b>L</b>	Individual wiring: With connector assembly (Lead wire length: 300 mm)
<b>LO</b>	Individual wiring: Without connector assembly

Select the 25A-ZK2VAAK□LOA-A for a switch with energy saving function.

### Connector assembly

ZK2 - LV **W** □ - A

Applicable valve type

<b>W</b>	Valve type K/R
<b>S</b>	Valve type J

Lead wire length

—	300 mm
<b>6</b>	600 mm
<b>10</b>	1000 mm
<b>20</b>	2000 mm
<b>30</b>	3000 mm

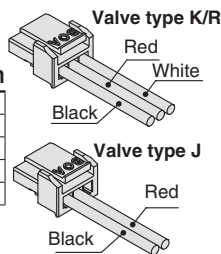

### Sound absorbing material (10 pcs. per set)

ZK2 - SE1 - **1** - A

Sound absorbing material hole diameter

<b>1</b>	300 μm
----------	--------

### Vacuum port adapter assembly (Purchasing order is available in units of 1 piece.)

ZK2 - VA1S **8** - A

One-touch fitting size

<b>6</b>	∅ 6 One-touch fitting	Metric size
<b>8</b>	∅ 8 One-touch fitting	

### Filter element (10 pcs. per set)

ZK2 - FE1 - **3** - A

Nominal filtration rating

<b>3</b>	30 μm
----------	-------

### Body gasket\*<sup>1</sup> (10 pcs. per set)

ZK2 - BG5 - **1** - A

Applicable type

<b>1</b>	One check valve type (All specifications other than vacuum switch with energy saving function and exhaust interference prevention valve)
<b>2</b>	Two check valve type (Vacuum switch with energy saving function and exhaust interference prevention valve)

\*1 When ZK2 - BG5 - 2 - A is mounted, the workpiece cannot be removed until vacuum is released.

### Filter case\*<sup>1</sup>

ZK2 - FC □ - A

Port for the pressure switch or sensor

Symbol	Port for the pressure switch or sensor	Filter case colour
<b>P</b>	With port (type with pressure switch or sensor)	Smoke
<b>T</b>	Without port (type without pressure switch or sensor)	Clear

\*1 Vacuum port adapter assembly is not included.

### Pressure switch for vacuum assembly (With 2 mounting screws)

25A-ZK2 - ZS **E** **A** **M** **G** - A

① ② ③ ④

### ① Rated pressure range and function

Symbol	Rated pressure range	Function	Output
<b>E</b>	0 to -101 kPa	Pressure switch for vacuum	Open collector 2 outputs
<b>F</b>	-100 to 100 kPa	Pressure switch for vacuum	Open collector 1 output
<b>V</b>	-100 to 100 kPa	Pressure switch for vacuum with energy saving function	Open collector 1 output

### ② Output

<b>A</b>	NPN
<b>B</b>	PNP

### ③ Unit

—	Unit selection function* <sup>1</sup>
<b>M</b>	SI unit only* <sup>2</sup>

\*1 The unit selection function is not available in Japan due to the New Measurement Law.

\*2 Fixed unit: kPa

### ④ Lead wire with connector

Symbol	Lead wire with connector	Function
—	None	None
<b>G</b>	With lead wire	When ① is E or F...For pressure switch for vacuum, Lead wire with connector (Length 2 m)
	With lead wire	When ① is V...For pressure switch for vacuum with energy saving function, Lead wire with connector (Length 2 m)

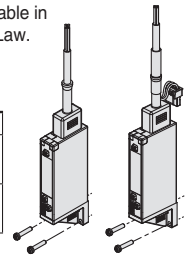

### Lead wire with connector

(When individual lead wire is necessary, order with the port number below.)

- Lead wire with connector for pressure switch for vacuum **ZS - 39 - 5G**
- Lead wire with connector for pressure switch for vacuum with energy saving function **ZK2 - LW **A** 20 - A**

### Output

<b>A</b>	NPN open collector
<b>B</b>	PNP open collector

### Pressure sensor assembly (With 2 mounting screws)

25A-ZK2 - PS **1** - A

### Rated pressure range

<b>1</b>	0 to -101 kPa, Output: 1 to 5 V, Accuracy: ± 2 % F.S.
<b>3</b>	-100 to 100 kPa, Output: 1 to 5 V, Accuracy: ± 2 % F.S.

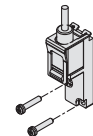

### High-noise reduction silencer case assembly

ZK2 - SC3 - **4** - A

Applicable nozzle size

<b>4</b>	For nozzle size 07, 10
<b>6</b>	For nozzle size 12, 15

### Release lever (10 pcs. per set)

ZK2 - RL1 - A

### Round lock (10 pcs. per set)

ZK2 - LN1 - A

**Optional Specifications/Functions/Applications**

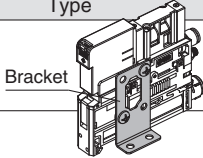
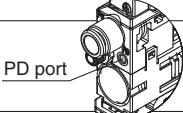
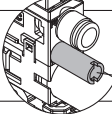
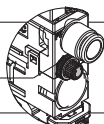
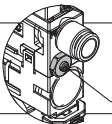
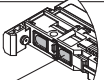
Symbol	Type	Function/Application
<b>B</b>	Mounting bracket for single unit (nuts and bolts are included)  Bracket	· Use when a single unit is mounted to the floor in an upright position is requested. If only ordering the bracket, the product number is as follows: 25A-ZK2-BK1-A (includes nuts and bolts).
<b>D</b>	With individual release pressure supply (PD) port (M3)  PD port	· Use when supply pressure for vacuum release is individually requested.
<b>E</b>	Screwdriver operation type long lock nut  Screwdriver operation type long lock nut	· Used when the needle adjustment operation is difficult
<b>J</b>	Vacuum break flow adjusting needle Round lock nut  Lock nut	· Thicker than standard hexagon type. More suitable for hand tightening. · Round lock nut improves operability when the port exhaust type is used.
<b>K</b>	Screwdriver operation type  Vacuum break flow adjusting needle	· Slotted type improves fine adjustment performance when the port exhaust type is used.
<b>W</b>	With exhaust interference prevention valve  Exhaust interference prevention valve	· When ejectors are operated individually, exhausted air may flow backward from the V port of ejectors that are turned off. Exhaust interference prevention valve prevents backflow.

# Vacuum Unit

# 25A-ZK2 Series

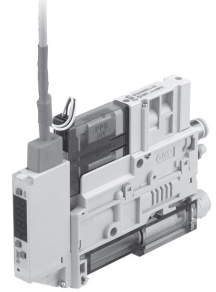

## How to Order Single Unit

Ejector System (with Valve)

25A-ZK2 **A** **12** **K** **5** **C** **L** - **08** - [ ]

Ejector System (without Valve)

25A-ZK2 **A** **12** **N** **0** **N** **N** - **08** - [ ]

① ② ③ ④ ⑤ ⑥ ⑦ ⑧

Remains blank when no option is selected.

### ① System/Body type

Symbol	Body type	Exhaust type
<b>A</b>	Single unit	Silencer exhaust
<b>B</b>		Port exhaust*1
<b>G</b>		High-noise reduction silencer exhaust

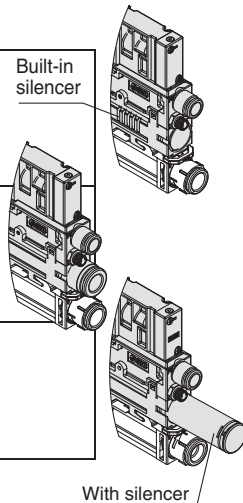

\*1 Port size of exhaust port:  $\varnothing 8$  (Metric)

With silencer

### ③ Combination of supply valve and release valve\*3

Symbol	Supply valve	Release valve
*5 <b>K</b>	N.C.	N.C.
<b>J</b>	N.C.	None
<b>R</b>	Self-holding release valve linked*4	N.C.
<b>N</b>	None	None

\*3 Only non-locking type is available for the manual override for "K," "J," and "R."  
 \*4 Self-holding type maintains vacuum by instantaneous energisation (20 ms or more). Stopping the vacuum turns on the release valve. (signal to stop vacuum not needed)  
 \*5 When the digital pressure switch for vacuum with energy saving function is selected for ⑤, select "K" for ③ Combination of supply valve and release valve.

### ② Nominal nozzle size

Symbol	System	Nominal size
<b>07</b>	Ejector system*2	$\varnothing 0.7$
<b>10</b>		$\varnothing 1.0$
<b>12</b>		$\varnothing 1.2$
<b>15</b>		$\varnothing 1.5$

\*2 Standard supply pressure for nozzle size  
 07 to 12: 0.35 MPa  
 15: 0.4 MPa

### ④ Rated voltage\*6

Symbol	Voltage
<b>5</b>	24 VDC
<b>6</b>	12 VDC
<b>0</b>	When ③ is "N"

\*6 Rated voltage for the supply and release valve

### ⑤ Pressure sensor/Digital pressure switch for vacuum specifications

Symbol	Type	Pressure range [kPa]	Specifications
<b>P</b>	Pressure sensor	0 to -101	Analogue output 1 to 5 V
<b>T</b>		-100 to 100	Analogue output 1 to 5 V
<b>A</b>	Digital pressure switch for vacuum	0 to -101	NPN 2 outputs Unit selection function
<b>B</b>			SI unit only*7
<b>C</b>			PNP 2 outputs Unit selection function
<b>D</b>			SI unit only*7
<b>E</b>		-100 to 100	NPN 2 outputs Unit selection function
<b>F</b>			SI unit only*7
<b>H</b>			PNP 2 outputs Unit selection function
<b>J</b>			SI unit only*7
<b>K</b>	Digital pressure switch for vacuum with energy saving function*9	-100 to 100	NPN 1 output Unit selection function
<b>Q</b>			SI unit only*7
<b>R</b>			PNP 1 output Unit selection function
<b>S</b>			SI unit only*7
<b>N</b>	Without pressure sensor/ Digital pressure switch for vacuum		

\*7 Fixed unit: kPa  
 \*8 When "K," "Q," "R," or "S" is selected, select "K" for ③ Combination of supply valve and release valve. Select "W" or "L3" for ⑥.

Manifold type is not available.

- PV: Air pressure supply port/Port for vacuum source (Vacuum pump)
- PS: Pilot pressure supply port ● PD: Individual release pressure supply port
- V: Vacuum port ● EXH: Exhaust port ● PE: Pilot pressure exhaust port

## 6 Supply valve/Release valve/Digital pressure switch for vacuum connector specifications

Symbol	3 For supply valve/release valve*10		5 Lead wire with connector for pressure switch/ sensor*13	Image
	Connector type	Lead wire with connector		
L	L-type plug connector	○*11	○*14	
L1		×*12	○*14	
L2		○*11	×*15	
L3		×*12	×*15	
W		With lead wire for switch with energy saving function		
Y	Non-valve (without supply/release valve)		○*14	
Y1	When "N" is selected for 3		×	
N	When "N" is selected for both 3 and 5 (without supply/release valve, without switch, pressure sensor)			

- \*10 Solenoid valve with light/surge voltage suppressor
- \*11 The standard lead wire length for the solenoid valve is 300 mm.
- \*12 For lead wire lengths other than the standard, select "L1 or L3," and order a connector assembly with the desired length. (Refer to page 143.)
- \*13 The standard lead wire length for the pressure sensor is 3 m. The standard length for the lead wire with connector for the vacuum pressure switch and the lead wire length for the switch with energy saving function is 2 m.
- \*14 Select "L," "L1," or "Y" when the pressure sensor (P, T) is selected for 5 Pressure sensor/Digital pressure switch for vacuum specifications. Since only the grommet type is available for the pressure sensor, the sensor without a lead wire cannot be selected.
- \*15 Select when no vacuum pressure switch, pressure sensor, or vacuum pressure switch with connector without a lead wire is used.

## 7 Vacuum (V) port\*16

Symbol	Type	Port size	
06	Metric size	Ø 6 One-touch fitting	
08		Ø 8 One-touch fitting	

\*16 Supply (PV) port size of single unit: Ø 6

## 8 Optional Specifications\*17

Symbol	Type
—	Without option
B	With one bracket for mounting a single unit (A mounting screw is attached.)
D	With individual release pressure supply (PD) port*18
J	Vacuum break flow adjusting needle Round lock nut type
K	Vacuum break flow adjusting needle Screwdriver operation type
W	With exhaust interference prevention valve*19, *20, *21

- \*17 When more than one option is selected, list the option symbols in an alphabetical order. Example) -BJ
- \*18 Only M3 is available for PD port size. Use One-touch fittings or barb fittings with O.D. Ø 6.2 or less for piping. (Recommended fitting: M-3AU-4)
- \*19 To prevent backflow of the exhaust air, not for holding vacuum. This option does not completely stop the backflow of the exhaust air. Select the port exhaust type according to the application.
- \*20 When "J" is selected for 3 Combination of supply valve and release valve and "W" (exhaust interference prevention valve type) is selected for 8 Optional specifications/ Functions/Applications, install a release valve or vacuum breaker.
- \*21 When "K," "Q," "R," or "S" is selected for 5 Pressure sensor/Digital pressure switch for vacuum specifications, a model with an exhaust interference prevention valve is provided. So, it is not necessary to select "W."

## Single Unit and Options\*22

1 System/ Body type	2 Nominal nozzle size	3 Combination of supply valve and release valve	4 Rated voltage	5 Pressure sensor/digital pressure switch for vacuum specifications	6 Supply valve/release valve/digital pressure switch for vacuum connector specifications	7 Vacuum (V) port	8 Optional specifications
A/B/G	07 10 12 15	K	5 6	P/T	L/L1	06 08	B/D/J/K/W
				A/B/C/D/E/F/H/J	L/L1/L2/L3		
				N	L2/L3		
		K/Q/R/S		L3/W			
		P/T		L/L1			
		A/B/C/D/E/F/H/J		L/L1/L2/L3			
	R	N	L2/L3				
			P/T	L/L1			
			A/B/C/D/E/F/H/J	L/L1/L2/L3			
	J	N	L2/L3				
			P/T	L/L1			
			A/B/C/D/E/F/H/J	L/L1/L2/L3			
N	0	P/T	Y	B/W			
		A/B/C/D/E/F/H/J	Y/Y1				
		N	N				

\*22 When "J" or "N" is selected for 3 Combination of Supply Valve and Release Valve, "D," "J," and "K" cannot be selected for 8 Optional Specifications/Functions/Applications.

For options not listed in the table above, please contact SMC.

\* Refer to the **Catalogue** at [www.smc.eu](http://www.smc.eu) when mounting single unit to DIN rail.

\* The 25A- series specifications and dimensions are the same as those of the standard model.



# 25A-ZK2 Series

## Replacement Parts/How to Order

### ■ Valve assembly

25A - ZK2 - VA **A** **K** **5** **L** - A

① ② ③ ④

#### ① Applicable system

<b>A</b>	For ejector system
----------	--------------------

#### ② Valve type

<b>K</b>	Supply valve N.C., Release valve N.C.
<b>R</b>	Supply valve, self-holding type (Linked to release valve)
<b>J</b>	Supply valve only (Single)

#### ③ Rated voltage

<b>5</b>	24 VDC
<b>6</b>	12 VDC

#### ④ Lead wire entry direction

<b>L</b>	L-type plug connector with lead wire (Individual wiring)
<b>LO</b>	L-type plug connector, without connector

Select the ZK2-VAAK□LO-A for a switch with energy saving function. This assembly does not include special cable assembly for a switch with energy saving function.

### ■ Vacuum pressure switch assembly

25A - ZK2 - ZS **E** **A** **M** **G** - A

① ② ③ ④

#### ① Rated pressure range and function

<b>E</b>	0 to -101 kPa	Vacuum pressure switch	Open collector 2 outputs
<b>F</b>	-100 to 100 kPa		
<b>V</b>	-100 to 100 kPa	Pressure switch with energy saving function	Open collector 1 output

#### ② Output specifications

<b>A</b>	NPN
<b>B</b>	PNP

#### ③ Unit specifications

—	Unit selection function
<b>M</b>	SI unit only*1

\*1 Fixed unit: kPa

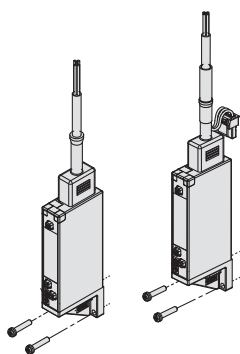

#### ④ Lead wire with connector

—	None	
<b>G</b>	With lead wire	When ① is E or F...For vacuum pressure switch, Lead wire with connector (Length 2 m)
		When ① is V...For switch with energy saving function, Lead wire with connector (Length 2 m)

### ■ Connector assembly

ZK2 - LV **W** □ - A

#### ● Applicable valve type

<b>W</b>	Valve type K/R (With supply valve and release valve)
<b>S</b>	Valve type J (Supply valve only)

#### ● Lead wire length

—	300 mm
<b>6</b>	600 mm
<b>10</b>	1000 mm
<b>20</b>	2000 mm
<b>30</b>	3000 mm

#### For single

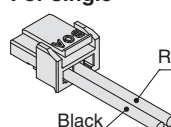

#### For double

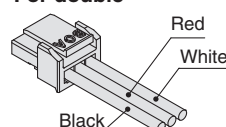

### ■ Lead wire with connector for vacuum pressure switch

(When individual lead wire is necessary, order with the part number below.)

#### ● Lead wire with connector for vacuum pressure switch

**ZS - 39 - 5G**

#### ● Lead wire with connector for switch with energy saving function

**ZK2 - LW **A** 20 - A**

#### ● Output specifications

<b>A</b>	NPN open collector
<b>B</b>	PNP open collector

### ■ Pressure sensor assembly

25A - ZK2 - PS **1** - A

#### Rated pressure range and specifications

<b>1</b>	0 to -101 kPa, Output: 1 to 5 V, Accuracy: ±2 % F.S. or less
<b>3</b>	-100 to 100 kPa, Output: 1 to 5 V, Accuracy: ±2 % F.S. or less

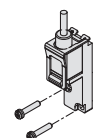

### ■ High-noise reduction silencer case assembly

ZK2 - SC3 - **4** - A

#### ● Exhaust port size

<b>4</b>	Ø 4	For nozzle size 07, 10
<b>6</b>	Ø 6	For nozzle size 12, 15

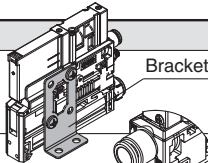
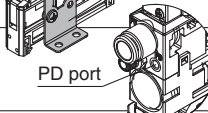
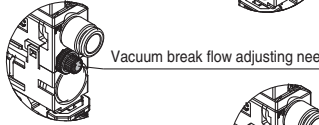
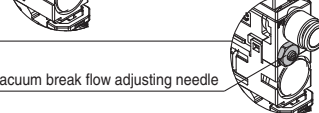
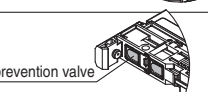

## Optional Specifications/Functions/Applications

Symbol	Type	Function/Application
<b>B</b>	With one bracket for mounting a single unit (Mounting screw is attached.) 	<ul style="list-style-type: none"> <li>Use when a single unit is mounted to the floor in an upright position is requested. (The part number for ordering only a bracket is 25A-ZK2-BK1-A. Bolt nuts are included.)</li> </ul>
<b>D</b>	With individual release pressure supply (PD) port 	<ul style="list-style-type: none"> <li>Use when supply pressure for vacuum release which pressure is different from the ejector supply pressure is requested.</li> </ul>
<b>J</b>	Vacuum break flow adjusting needle Round lock nut type 	<ul style="list-style-type: none"> <li>Thicker than standard hexagon type. More suitable for hand tightening.</li> <li>Round lock nut improves operability when the exhaust port type is used.</li> </ul>
<b>K</b>	Vacuum break flow adjusting needle Screwdriver operation type 	<ul style="list-style-type: none"> <li>Slotted type improves fine adjustment performance when the exhaust port type is used.</li> </ul>
<b>W</b>	With exhaust interference prevention valve 	<ul style="list-style-type: none"> <li>When ejectors are operated individually, exhausted air may flow backward from the V port of ejectors that are turned off. Exhaust interference prevention valve prevents backflow.</li> </ul>

# Space Saving Vacuum Ejector

## 25A-ZQ Series

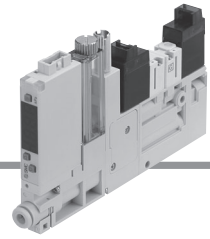

### How to Order

#### Ejector Unit

**25A-ZQ1** 05 1U - K1   5 L   - EB   G   -     - **Q**

• **Series compatible with secondary batteries**

#### ① Nozzle nominal size

<b>05</b>	∅ 0.5
<b>07</b>	∅ 0.7
<b>10</b>	∅ 1.0

#### ② Exhaust type

<b>1U</b>	With silencer for single unit
<b>3M</b>	With silencer for manifold

#### ③ Solenoid valve combination (Refer to Table (1).)

Symbol	Supply valve	Vacuum release valve
<b>K1</b>	Normally closed	Normally closed
<b>K2</b> *1	Normally open	Normally closed
<b>J1</b>	Normally closed	None
<b>J2</b> *1	Normally open	None
<b>Q1</b>	Latching positive common	Normally closed
<b>Q2</b>	Latching positive common	None
<b>N1</b>	Latching negative common	Normally closed
<b>N2</b>	Latching negative common	None

\*1 In cases when "K2" or "J2" (supply valve normally open) is selected for the solenoid valve combination, when vacuum is stopped for long periods of time (10 minutes or more), do not continue to energise the supply valve, and shut off the air supply.

#### ④ Pilot valve (Refer to Table (1).)

<b>—</b>	Standard (DC: 1 W)*2
<b>Y</b>	DC low wattage type (0.5 W)*2

\*2 Avoid energising the solenoid valve for long periods of time. (Refer to Design and Selection on Specific Product Precautions.)

#### ⑤ Solenoid valve rated voltage (Refer to Table (1).)

<b>5</b>	24 VDC
<b>6</b>	12 VDC

**Table (1) Combination of Solenoid Valve, Pilot Valve and Power Supply Voltage**

Combination no.	Solenoid valve combination symbol	Pilot valve symbol	Applicable power supply voltage [V]	
			24 DC	12 DC
①	<b>K1</b>	<b>—</b>	●	●
②	<b>K1</b>	<b>Y</b>	●	●
③	<b>K2</b>	<b>—</b>	●	●
④	<b>J1</b>	<b>—</b>	●	●
⑤	<b>J1</b>	<b>Y</b>	●	●
⑥	<b>J2</b>	<b>—</b>	●	●
⑦	<b>Q1</b>	<b>—</b>	●	●
⑧	<b>Q2</b>	<b>—</b>	●	●
⑨	<b>N1</b>	<b>—</b>	●	●
⑩	<b>N2</b>	<b>—</b>	●	●

\* Combinations ① to ⑩ in the above table are the only possible options.

## ⑥ Electrical entry

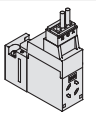
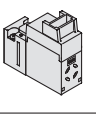
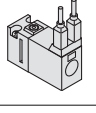
<b>L</b>	L-type plug connector, with 0.3 m lead wire, with light/surge voltage suppressor	
<b>LO</b>	L-type plug connector, without connector, with light/surge voltage suppressor	
<b>G</b>	Grommet, with 0.3 m lead wire (Latching/AC type: Not applicable)	

## ⑦ Manual override\*4

—	Non-locking push type Latching type: Push-locking type
<b>B</b>	Locking type (Q1/Q2/N1/N2: Not applicable)

\*4 Latching type supply valve: Available in “—” only. In this case, the supply valve and release valve come with a push-locking type.

## ⑧ Vacuum pressure switch suction filter\*5

<b>EA</b>	0 to -101 kPa/NPN open collector 2 outputs, with suction filter
<b>EB</b>	0 to -101 kPa/PNP open collector 2 outputs, with suction filter
<b>EC</b>	0 to -101 kPa/NPN open collector 1 output + analogue voltage, with suction filter
<b>EE</b>	0 to -101 kPa/PNP open collector 1 output + analogue voltage, with suction filter
<b>FA</b>	100 to -100 kPa/NPN open collector 2 outputs, with suction filter
<b>FB</b>	100 to -100 kPa/PNP open collector 2 outputs, with suction filter
<b>FC</b>	100 to -100 kPa/NPN open collector 1 output + analogue voltage, with suction filter
<b>FE</b>	100 to -100 kPa/PNP open collector 1 output + analogue voltage, with suction filter
<b>F</b>	Suction filter only

\*5 The filter included in this product is of a simple type, and will become clogged quickly in environments with high quantities of dust or particulates. Please make additional use of an air suction filter of the ZFA, ZFB or ZFC series.

### **⚠ Warning**

The filter case of this suction filter is made of nylon. Contact with alcohol or similar chemicals may cause it to be damaged. Also, do not use the filter when these chemicals are present in the atmosphere.

## ⑪ Check valve\*8

—	None
<b>K</b>	With check valve

\*8 The check valve has a function to prevent the exhaust air from the silencer overflowing to the vacuum port side when a manifold is used. However, depending on usage conditions, it does not always suppress air overflow to the desired extent. During usage, please inspect thoroughly with actual machine. Also, in order to completely prevent the overflow of exhaust air, leave plenty of space between the check valve unit and adjacent ejector to avoid interference from the ejector's exhaust unit.

### **⚠ Warning**

- ① Cannot be used for vacuum retention.
- ② Use a release valve. (Without a release valve, a workpiece may not be released.)

## ⑫ Fitting (V port)

Symbol	Applicable tubing O.D.
<b>0</b>	Without fitting (M5 x 0.8)

## ⑬ Fitting (P port)

Symbol	Applicable tubing O.D.	Object spec.
—	Without port	Manifold
<b>0</b>	Without fitting (M5 x 0.8)	Single unit

## ⑨ Vacuum pressure switch unit specifications

—	With unit switching function
<b>M</b>	Fixed SI unit*6
<b>P</b>	With unit switching function (Initial value psi)

\*6 Fixed unit: kPa

## ⑩ Vacuum pressure switch lead wire specifications

—	Without connector
<b>G</b>	Lead wire with connector (Lead wire length 2 m) With connector cover

\* The 25A- series specifications and dimensions are the same as those of the standard model.

## How to Order

**Manifold** 25A – ZZQ1 **07** – **B S C**

### Number of stations\*1

01	1 station
02	2 stations
⋮	⋮
08	8 stations

\*1 Number of stations varies according to nozzle nominal size during simultaneous operation.

### Maximum Number of Stations in Simultaneous Operation

Nozzle nominal size	Maximum number of stations in simultaneous operation
Ø 0.5	8 stations
Ø 0.7	6 stations
Ø 1.0	4 stations

### Air pressure supply (P) port position

**B** Both sides

### Exhaust

**S** With silencers (Both sides)

### Vacuum release pressure supply port (PD port)

<b>B</b>	None (Release pressure is supplied from the P port.)
<b>C</b>	Provided (Air can be alternatively supplied from the P port.)

\* The 25A- series specifications and dimensions are the same as those of the standard model.

## How to Order

### Solenoid valve

**Actuation**

1	Normally closed
2	Normally open

**Pilot valve**

—	Standard (DC: 1 W)
Y	DC low wattage type (0.5 W)
L	Latching positive common
N	Latching negative common

**Solenoid valve rated voltage**

5	24 VDC
6	12 VDC

**Manual override\*1**

—	Non-locking push type
B	Latching type: Push-locking type
	Locking type

\*1 Latching type: Available in "—" only

**Electrical entry\*2**

L	L-type plug connector, with 0.3 m lead wire	
LO	L-type plug connector, without connector	
G	Grommet, with 0.3 m lead wire (Latching/AC type: Not applicable)	

\*2 Mounting screws are attached.

**25A-ZQ1-VQ1 1 0 [ ] - 5 L [ ]**

**25A-ZQ1-VQ1 2 0 [ ] - 5 L [ ]**

### Vacuum pressure switch

**25A-ZQ1-ZS [ ] [ ] [ ] [ ] - [ ] - A**

**Vacuum pressure switch specifications**

EA	0 to -101 kPa/NPN open collector 2 outputs, with suction filter
EB	0 to -101 kPa/PNP open collector 2 outputs, with suction filter
EC	0 to -101 kPa/NPN open collector 1 output + analogue voltage, with suction filter
EE	0 to -101 kPa/PNP open collector 1 output + analogue voltage, with suction filter
FA	100 to -100 kPa/NPN open collector 2 outputs, with suction filter
FB	100 to -100 kPa/PNP open collector 2 outputs, with suction filter
FC	100 to -100 kPa/NPN open collector 1 output + analogue voltage, with suction filter
FE	100 to -100 kPa/PNP open collector 1 output + analogue voltage, with suction filter

**Vacuum pressure switch unit specifications**

—	With unit switching function
M	Fixed SI unit*1
P	With unit switching function (Initial value psi)

\*1 Fixed unit: kPa

**Fitting (V port)**

Symbol	Applicable tubing O.D.
0	Without fitting (M5 x 0.8)

**Check valve\*3**

—	None
K	With check valve

\*3 The check valve has a function to prevent the exhaust air from the silencer overflowing to the vacuum port side when a manifold is used, but it is incapable of completely preventing overflow. During usage, please inspect thoroughly with actual machine. Also, in order to completely prevent the overflow of exhaust air, leave plenty of space between the check valve unit and adjacent ejector to avoid interference from the ejector's exhaust unit.

**Warning**

- Cannot be used for vacuum retention.
- Use a vacuum release valve. (Without a vacuum release valve, the workpiece may not be released.)

**Vacuum pressure switch lead wire specifications**

—	Without connector
G	Lead wire with connector (lead wire length 2 m) With connector cover

Lead wire with connector part no.	Note
ZS-39-5G	Lead wire length 2 m (With connector cover)

\* The 25A- series specifications and dimensions are the same as those of the standard model.

# Space Saving Vacuum Pump System

## 25A-ZQ Series

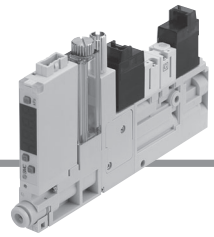

### How to Order

#### Vacuum pump unit

25A-ZQ1000 **U** - **K1** **5** **L** - **EB** **G** - **Q**

① ② ③ ④ ⑤ ⑥ ⑦ ⑧ ⑨ ⑩ ⑪

• Series compatible with secondary batteries

#### ① Body type

<b>U</b>	For single unit
<b>M</b>	For manifold

#### ② Solenoid valve combination (Refer to Table (1).)

Symbol	Supply valve	Vacuum release valve
<b>K1</b>	Normally closed	Normally closed
<b>K2</b> *1	Normally open	Normally closed
<b>J1</b>	Normally closed	None
<b>J2</b> *1	Normally open	None
<b>Q1</b>	Latching positive common	Normally closed
<b>Q2</b>	Latching positive common	None
<b>N1</b>	Latching negative common	Normally closed
<b>N2</b>	Latching negative common	None

⚠ The air in the adsorption section of this product is not released to the atmosphere at the vacuum suspension state.  
As for "K1," "K2," "Q1" and "N1," use the vacuum release valve when a workpiece is detached.  
Concerning "J1," "J2," "Q2" and "N2," devise the circuit for the vacuum release additionally when a workpiece is detached.

\*1 In cases when "K2" or "J2" (supply valve normally open) is selected for the solenoid valve combination, when vacuum is stopped for long periods of time (10 minutes or more), do not continue to energise the supply valve, and shut off the air supply.

#### ③ Pilot valve (Refer to Table (1).)

—	Standard (DC: 1 W)*2
<b>Y</b>	DC low wattage type (0.5 W)*2

\*2 Avoid energising the solenoid valve for long periods of time. (Refer to Specific Product Precautions; Caution on Design and Selection.)

#### ④ Solenoid valve rated voltage (Refer to Table (1).)



<b>5</b>	24 VDC
<b>6</b>	12 VDC

**Table (1) Combination of Solenoid Valve, Pilot Valve and Rated Voltage**

Combination-no.	Solenoid valve-combination-symbol	Pilot valve symbol	Applicable power supply voltage [V]	
			24 DC	12 DC
①	<b>K1</b>	—	●	●
②	<b>K1</b>	<b>Y</b>	●	●
③	<b>K2</b>	—	●	●
④	<b>J1</b>	—	●	●
⑤	<b>J1</b>	<b>Y</b>	●	●
⑥	<b>J2</b>	—	●	●
⑦	<b>Q1</b>	—	●	●
⑧	<b>Q2</b>	—	●	●
⑨	<b>N1</b>	—	●	●
⑩	<b>N2</b>	—	●	●

\* Combinations ① to ⑩ in the above table are the only possible options.

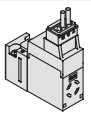
## ⑤ Electrical entry

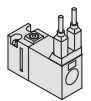
<b>L</b>	L-type plug connector, with 0.3 m lead wire, with light/surge voltage suppressor	
<b>LO</b>	L-type plug connector, without connector, with light/surge voltage suppressor	
<b>G</b>	Grommet, with 0.3 m lead wire	

## ⑥ Manual override\*4

—	Non-locking push type Latching type: Push-locking type
<b>B</b>	Locking type (Q1/Q2/N1/N2: Not applicable)

\*4 Latching type supply valve: Available in “—” only. In this case, the supply valve and release valve come with a push-locking type.

## ⑦ Vacuum pressure switch suction filter\*5

<b>EA</b>	0 to -101 kPa/NPN open collector 2 outputs, with suction filter
<b>EB</b>	0 to -101 kPa/PNP open collector 2 outputs, with suction filter
<b>EC</b>	0 to -101 kPa/NPN open collector 1 output + analogue voltage, with suction filter
<b>EE</b>	0 to -101 kPa/PNP open collector 1 output + analogue voltage, with suction filter
<b>FA</b>	100 to -100 kPa/NPN open collector 2 outputs, with suction filter
<b>FB</b>	100 to -100 kPa/PNP open collector 2 outputs, with suction filter
<b>FC</b>	100 to -100 kPa/NPN open collector 1 output + analogue voltage, with suction filter
<b>FE</b>	100 to -100 kPa/PNP open collector 1 output + analogue voltage, with suction filter
<b>F</b>	Suction filter only

\*5 The filter included in this product is of a simple type, and will become clogged quickly in environments with high quantities of dust or particulates. Please make additional use of an air suction filter of the ZFA, ZFB or ZFC series.

### ⚠ Warning

The filter case of this suction filter is made of nylon. Contact with alcohol or similar chemicals may cause it to be damaged. Also, do not use the filter when these chemicals are present in the atmosphere.

## ⑩ Fitting (V port)\*8

Symbol	Applicable tubing O.D.
<b>0</b>	Without fitting (M5 x 0.8)

## ⑪ Fitting (PS / PV port)\*8

Symbol	Applicable tubing O.D.	Part no.	Object spec.
—	Without port	—	Manifold
<b>0</b>	Without fitting (M5 x 0.8)	—	Single unit

\*8 For filter only (Without vacuum pressure switch)  
When neither V port fitting nor PS/PV port fitting are needed, enter nothing or -00 in the dotted line “How to Order”.

## ⑧ Vacuum pressure switch unit specifications

—	With unit switching function
<b>M</b>	Fixed SI unit*6
<b>P</b>	With unit switching function (Initial value psi)

\*6 Fixed unit: kPa

## ⑨ Vacuum pressure switch lead wire specifications

—	Without connector
<b>G</b>	Lead wire with connector (Lead wire length 2 m) With connector cover

\* The 25A- series specifications and dimensions are the same as those of the standard model.



## How to Order

**Manifold** 25A-ZZQ1 **08** - **O**

Number of stations ●

01	1 station
02	2 stations
⋮	⋮
08	8 stations

Vacuum pressure supply port (PV port)  
Port location  
(Refer to Table (1).)

L	Left side
R	Right side

**Table (1) Air Pressure Supply Port Location on the Manifold**

PD port	Manifold Port location	Left			Right		
		PS	PV	PD	PS	PV	PD
<b>B</b>	L (Left side)	—	●	—	●*1	—	—
	R (Right side)	●*1	—	—	—	●	—
<b>C</b>	L (Left side)	—	●	●	●	—	●
	R (Right side)	●	—	●	—	●	●

\*1 The position of each port is shown as right and left sides viewed from the front side of the vacuum port.

Release pressure is commonly supplied from the PS port.

\* PS: Pilot pressure supply port, PV: Vacuum pressure supply port, PD: Release pressure supply port

Release pressure supply port (PD port) ●

<b>B</b>	None (Release pressure is supplied from the PS port.)
<b>C</b>	Provided (Air can be alternatively supplied from the PS port.)

\* The 25A- series specifications and dimensions are the same as those of the standard model.

## How to Order

### Solenoid valve

**Actuation**

1	Normally closed
2	Normally open

**Pilot valve**

—	Standard (DC: 1 W)
Y	DC low wattage type (0.5 W) * AC type: Not applicable
L	Latching positive common
N	Latching negative common

**Solenoid valve rated voltage**

5	24 VDC
6	12 VDC

**25A-ZQ1-VQ1 1 0** **5 L**

**25A-ZQ1-VQ1 2 0** **5 L**

**Actuation**

2	Normally open
---	---------------

**Pilot valve**

—	Standard (1 W)
---	----------------

**Solenoid valve rated voltage**

5	24 VDC
6	12 VDC

**Manual override\*1**

—	Non-locking push type
	Latching type: Push-locking type
B	Locking type

\*1 Latching type: Available in "—" only

**Electrical entry\*2**

L	L-type plug connector, with 0.3 m lead wire	
LO	L-type plug connector, without connector	
G	Grommet, with 0.3 m lead wire (Latching/AC type: Not applicable)	

\*2 Mounting screws are attached.

### Vacuum pressure switch

**25A-ZQ1-ZS** **— — — —** **—** **A**

**Vacuum pressure switch specifications**

EA	0 to -101 kPa/NPN open collector 2 outputs, with suction filter
EB	0 to -101 kPa/PNP open collector 2 outputs, with suction filter
EC	0 to -101 kPa/NPN open collector 1 output + analogue voltage, with suction filter
EE	0 to -101 kPa/PNP open collector 1 output + analogue voltage, with suction filter
FA	100 to -100 kPa/NPN open collector 2 outputs, with suction filter
FB	100 to -100 kPa/PNP open collector 2 outputs, with suction filter
FC	100 to -100 kPa/NPN open collector 1 output + analogue voltage, with suction filter
FE	100 to -100 kPa/PNP open collector 1 output + analogue voltage, with suction filter

**Vacuum pressure switch unit specifications**

—	With unit switching function
M	Fixed SI unit*1
P	With unit switching function (Initial value psi)

\*1 Fixed unit: kPa

**Vacuum pressure switch lead wire specifications**

—	Without connector
G	Lead wire with connector (Lead wire length 2 m) With connector cover

**Fitting (V port)**

Symbol	Applicable tubing O.D.
0	Without fitting (M5 x 0.8)

**Check valve\*3**

—	None
K	With check valve

\*3 The check valve has a function to prevent the exhaust air from the silencer overflowing to the vacuum port side when a manifold is used, but it is incapable of completely preventing overflow. During usage, please inspect thoroughly with actual machine. Also, in order to completely prevent the overflow of exhaust air, leave plenty of space between the check valve unit and adjacent ejector to avoid interference from the ejector's exhaust unit.

**Warning**

- Cannot be used for vacuum retention.
- Use a vacuum release valve. (Without a vacuum release valve, the workpiece may not be released.)

Lead wire with connector part no.	Note
ZS-39-5G	Lead wire length 2 m (With connector cover)

\* The 25A- series specifications and dimensions are the same as those of the standard model.

# Vacuum Regulator

# 25A-IRV10/20 Series

RoHS

## How to Order

**Standard connections** 25A-IRV 20 - [ ] C08 [ ] [ ]

Series compatible with secondary batteries

Body size

10	Max. flow 140 l/min (ANR)
20	Max. flow 240 l/min (ANR)

Fittings

—	Straight
L	Elbow

Connection tubing O.D.

Symbol	Tubing O.D.	IRV10	IRV20
C06	Metric	Ø 6	●
C08		Ø 8	●
C10		Ø 10	—

Accessory ② [Supplied with product]

—	None*1
GN	Gauge nut assembly*2

\*1 Two plug nuts are mounted on the gauge port. When the Rc1/8 port is required, please order the optional gauge nut assembly P601010-130 separately.

\*2 One plug nut, one gauge nut (Rc1/8), and two clips are included. The pressure gauge and digital pressure switch are not included.

Accessory ① [Supplied with product]

—	None
B	With bracket

**Single sided connections** 25A-IRV 20 A - [ ] C08 [ ] [ ]

Series compatible with secondary batteries

Body size

10	Max. flow 140 l/min (ANR)
20	Max. flow 240 l/min (ANR)

Single sided connections

A	Single sided connections
---	--------------------------

Fittings

—	Straight
L	Elbow

Connection tubing O.D.

Symbol	Tubing O.D.	IRV10A	IRV20A
C06	Metric	Ø 6	●
C08		Ø 8	●
C10		Ø 10	—

Accessory ② [Supplied with product]

—	None*1
GN	Gauge nut assembly*2

\*1 Two plug nuts are mounted on the gauge port. When the Rc1/8 port is required, please order the optional gauge nut assembly P601010-130 separately.

\*2 One gauge nut (Rc1/8) and one clip are included. The pressure gauge and digital pressure switch are not included.

Accessory ① [Supplied with product]

—	None
B	With bracket

\* This product cannot be used in environments containing chemical agents such as hydrofluoric acid, etc.

\* The 25A- series specifications and dimensions are the same as those of the standard model.

# Membrane Air Dryer

## 25A-IDG Series

### Single Unit/Standard Dew Point -40 °C/-60 °C Specifications

RoHS



#### How to Order

25A - IDG 50 L A - 03 - P

Series compatible with secondary batteries

Size

30
50
60
75
100

Standard dew point temperature

Symbol	Standard dew point [°C]
L	-40
S	-60

Symbol	30	50	60	75	100
L	●	●	●	●	●
S	—	—	●	●	●

Semi-standard

Symbol	Contents
—	None
R	Flow direction (Right → Left)

Fitting for purge air discharge

Symbol	Contents
P	With fitting for purge air discharge

Accessory

Symbol	Description
—	None
B	With bracket

\* When symbol B is indicated, a bracket assembly with a part number shown in the table left below is shipped together as an accessory, (but not assembled).

Port size

Symbol	Bore	Size				
		30	50	60	75	100
02	Rc1/4	●	●	—	—	—
03	Rc3/8	●	●	●	●	●
04	Rc1/2	—	—	●	●	●

#### Piping materials

Piping to the outlet side with piping made of water-absorbent or hydrophilic material (nylon, etc.) may result in a rising dew point on the outlet side. Therefore, be sure to use either stainless steel or fluoropolymer piping and fittings.

#### Bracket Assembly (Accessory) Part Nos.

Part no.	Applicable model
25A-BM64	25A-IDG30LA, 50LA
25A-BM65	25A-IDG60LA, 75LA, 100LA

\* Assembly of a bracket and 2 mounting screws

\* The 25A- series specifications are the same as those of the standard model.

# 25A-IDG Series

## Dimensions

25A-IDG30LA  
25A-IDG50LA

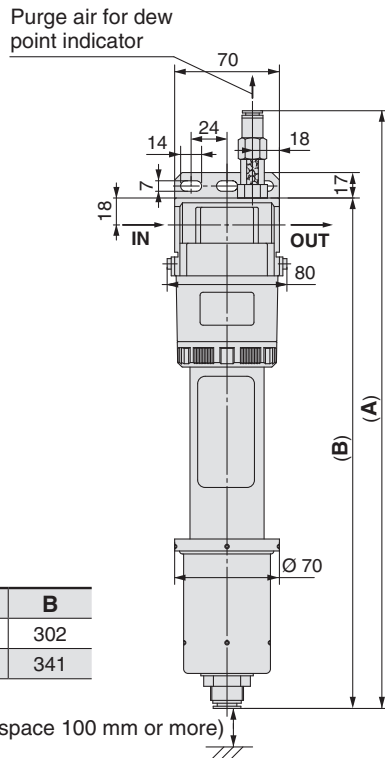

Model	A	B
25A-IDG30LA	361	302
25A-IDG50LA	400	341

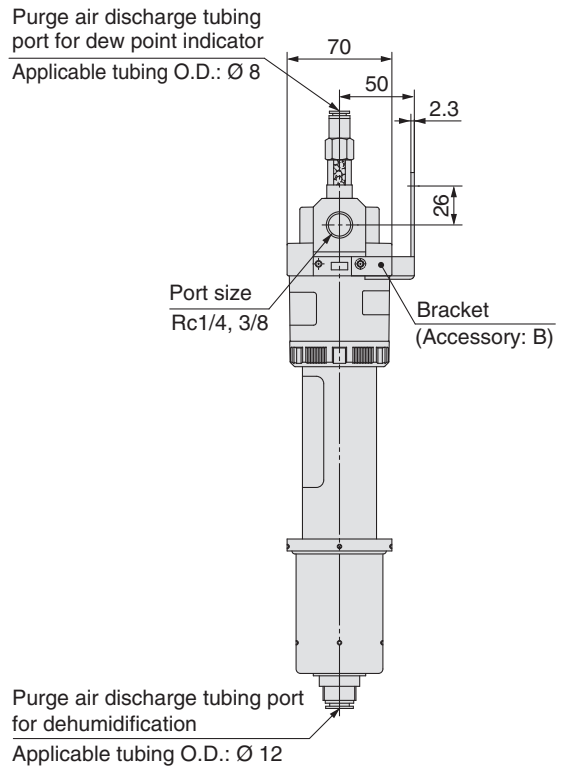

25A-IDG60LA  
25A-IDG75LA  
25A-IDG100LA

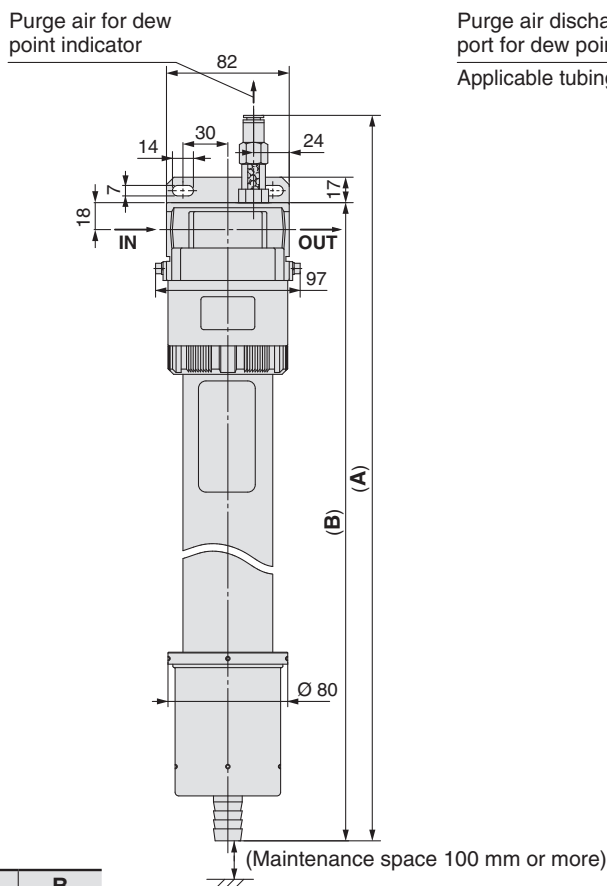

Model	A	B
25A-IDG60LA	426	367
25A-IDG75LA	495	436
25A-IDG100LA	560	501

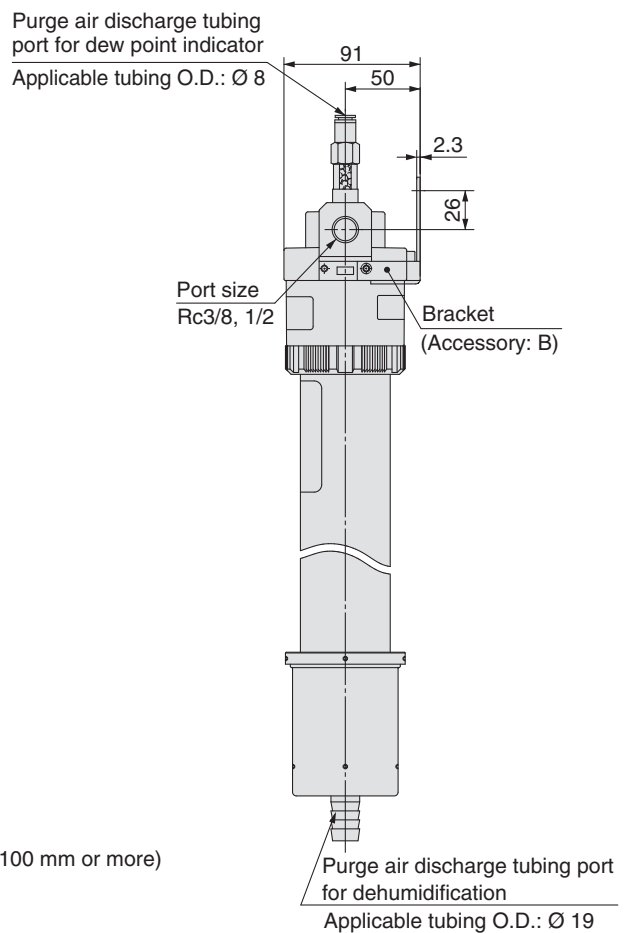

# Main Line Filter

# 25A-AFF Series



## How to Order

### 25A-AFF2C to 25A-AFF22C

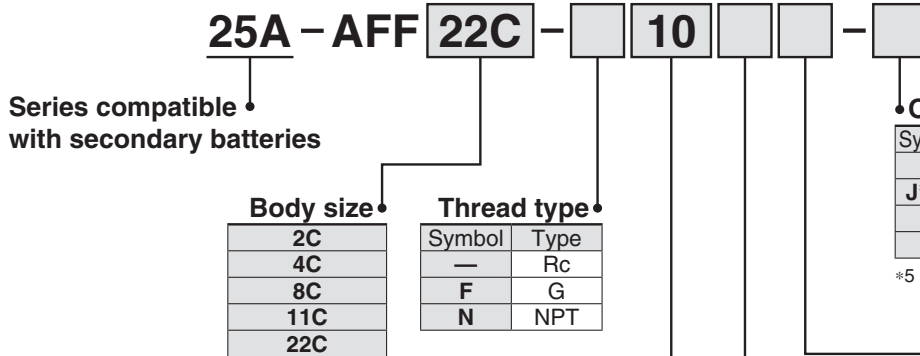

### Bracket Assembly Part Nos.\*3

Applicable model	Part no.
25A-AFF2C	25A-AM-BM101
25A-AFF4C	25A-AM-BM102
25A-AFF8C	25A-AM-BM103
25A-AFF11C	25A-AM-BM104
25A-AFF22C	25A-AM-BM105

\*3 Assembly of a bracket and 2 mounting screws

### Port size

Symbol	Size	Applicable body size				
		2C	4C	8C	11C	22C
01	1/8	●	—	—	—	—
02	1/4	●	●	—	—	—
03	3/8	—	●	●	—	—
04	1/2	—	—	●	●	—
06	3/4	—	—	—	●	●
10	1	—	—	—	—	●

### 25A-AFF37B/75B

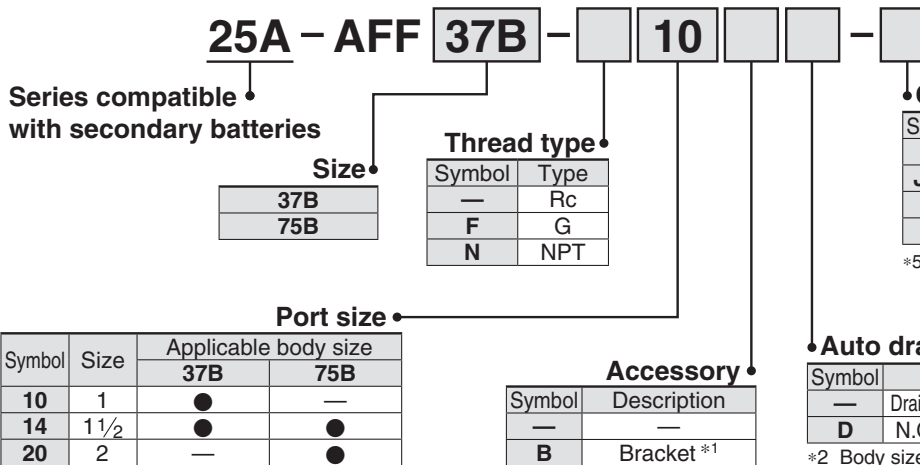

### Bracket Assembly Part Nos.\*3

Applicable model	Part no.
25A-AFF37B	25A-BM56
25A-AFF75B	25A-BM57

\*3 Assembly of a bracket and 2 mounting screws

\* The 25A- series specifications and dimensions are the same as those of the standard model.

# Mist Separator

# 25A-AM Series



## How to Order

### 25A-AM150C to 25A-AM550C

**25A - AM 550C - [ ] 10 [ ] [ ] - [ ]**

Series compatible with secondary batteries

Body size

150C
250C
350C
450C
550C

Thread type

Symbol	Type
—	Rc
F	G
N	NPT

Option

Symbol	Description
—	—
J*4,*5	Drain guide 1/4 female threaded
R	IN-OUT reversal direction
T	With element service indicator

\*5 Drain piping and piping for a stop valve such as ball valve are required.

Auto drain\*4

Symbol	Description
—	Drain cock (Without auto drain)
C	N.C. auto drain
D	N.O. auto drain

\*4 Only one drain exhaust method can be selected. The drain cock, N.C. auto drain, N.O. auto drain and drain guide cannot be selected together.

Accessory

Symbol	Description
—	—
B	Bracket *1

\*1 When symbol "B" is indicated, a bracket assembly with a part number shown in the left table is shipped together as an accessory, (but not assembled).

Port size

Symbol	Size	Applicable body size				
		150C	250C	350C	450C	550C
01	1/8	●	—	—	—	—
02	1/4	●	—	—	—	—
03	3/8	—	●	●	—	—
04	1/2	—	—	●	●	—
06	3/4	—	—	—	●	●
10	1	—	—	—	—	●

Bracket Assembly Part Nos.\*3

Applicable model	Part no.
25A-AM150C	25A-AM-BM101
25A-AM250C	25A-AM-BM102
25A-AM350C	25A-AM-BM103
25A-AM450C	25A-AM-BM104
25A-AM550C	25A-AM-BM105

\*3 Assembly of a bracket and 2 mounting screws

### 25A-AM650/850

**25A - AM 650 - [ ] 10 [ ] [ ] - [ ]**

Series compatible with secondary batteries

Body size

650
850

Thread type

Symbol	Type
—	Rc
F	G
N	NPT

Option

Symbol	Description
—	—
J*4,*5	Drain guide 1/4 female threaded (650 only)
R	IN-OUT reversal direction
T	With element service indicator

\*5 Drain piping and piping for a stop valve such as ball valve are required.

Auto drain\*4

Symbol	Description
—	Drain cock (Without auto drain) *2
D	N.O. auto drain (650 only)

\*2 Body size 850 is equipped with a ball valve (Rc 3/8 female threaded).

\*4 Body size 650: Only one drain exhaust method can be selected. The drain cock, N.O. auto drain and drain guide cannot be selected together.

Accessory

Symbol	Description
—	—
B	Bracket *1

\*1 When symbol "B" is indicated, a bracket assembly with a part number shown in the left table is shipped together as an accessory, (but not assembled).

Port size

Symbol	Size	Applicable body size	
		650	850
10	1	●	—
14	1 1/2	●	●
20	2	—	●

Bracket Assembly Part Nos.\*3

Applicable model	Part no.
25A-AM650	25A-BM56
25A-AM850	25A-BM57

\*3 Assembly of a bracket and 2 mounting screws

\* The 25A- series specifications and dimensions are the same as those of the standard model.



# Micro Mist Separator 25A-AMD Series



## How to Order

### 25A-AMD150C to 25A-AMD550C

**25A - AMD 550C** - [ ] [10] [ ] [ ] - [ ]

**Series compatible with secondary batteries**

**Body size**

150C
250C
350C
450C
550C

**Thread type**

Symbol	Type
—	Rc
F	G
N	NPT

**Option**

Symbol	Description
—	—
J*4,*5	Drain guide 1/4 female threaded
R	IN-OUT reversal direction
T	With element service indicator

\*5 Drain piping and piping for a stop valve such as ball valve are required.

**Auto drain\*4**

Symbol	Description
—	Drain cock (Without auto drain)
C	N.C. auto drain
D	N.O. auto drain

\*4 Only one drain exhaust method can be selected. The drain cock, N.C. auto drain, N.O. auto drain and drain guide cannot be selected together.

**Accessory**

Symbol	Description
—	—
B	Bracket *1

\*1 When symbol "B" is indicated, a bracket assembly with a part number shown in the left table is shipped together as an accessory, (but not assembled).

**Port size**

Symbol	Size	Applicable body size				
		150C	250C	350C	450C	550C
01	1/8	●	—	—	—	—
02	1/4	●	●	—	—	—
03	3/8	—	●	●	—	—
04	1/2	—	—	●	●	—
06	3/4	—	—	—	●	●
10	1	—	—	—	—	●

**Bracket Assembly Part Nos.\*3**

Applicable model	Part no.
25A-AMD150C	25A-AM-BM101
25A-AMD250C	25A-AM-BM102
25A-AMD350C	25A-AM-BM103
25A-AMD450C	25A-AM-BM104
25A-AMD550C	25A-AM-BM105

\*3 Assembly of a bracket and 2 mounting screws

### 25A-AMD650/850

**25A - AMD 650** - [ ] [10] [ ] [ ] - [ ]

**Series compatible with secondary batteries**

**Body size**

650
850

**Thread type**

Symbol	Type
—	Rc
F	G
N	NPT

**Option**

Symbol	Description
—	—
J*4,*5	Drain guide 1/4 female threaded (650 only)
R	IN-OUT reversal direction
T	With element service indicator

\*5 Drain piping and piping for a stop valve such as ball valve are required.

**Auto drain\*4**

Symbol	Description
—	Drain cock (Without auto drain) *2
D	N.O. auto drain (650 only)

\*2 Body size 850 is equipped with a ball valve (Rc 3/8 female threaded).

\*4 Body size 650: Only one drain exhaust method can be selected. The drain cock, N.O. auto drain and drain guide cannot be selected together.

**Accessory**

Symbol	Description
—	—
B	Bracket *1

\*1 When symbol "B" is indicated, a bracket assembly with a part number shown in the left table is shipped together as an accessory, (but not assembled).

**Port size**

Symbol	Size	Applicable body size	
		650	850
10	1	●	—
14	1 1/2	●	●
20	2	—	●

**Bracket Assembly Part Nos.\*3**

Applicable model	Part no.
25A-AMD650	25A-BM56
25A-AMD850	25A-BM57

\*3 Assembly of a bracket and 2 mounting screws

\* The 25A- series specifications and dimensions are the same as those of the standard model.

# Micro Mist Separator with Pre-filter 25A-AMH Series

RoHS



## How to Order

### 25A-AMH150C to 25A-AMH550C

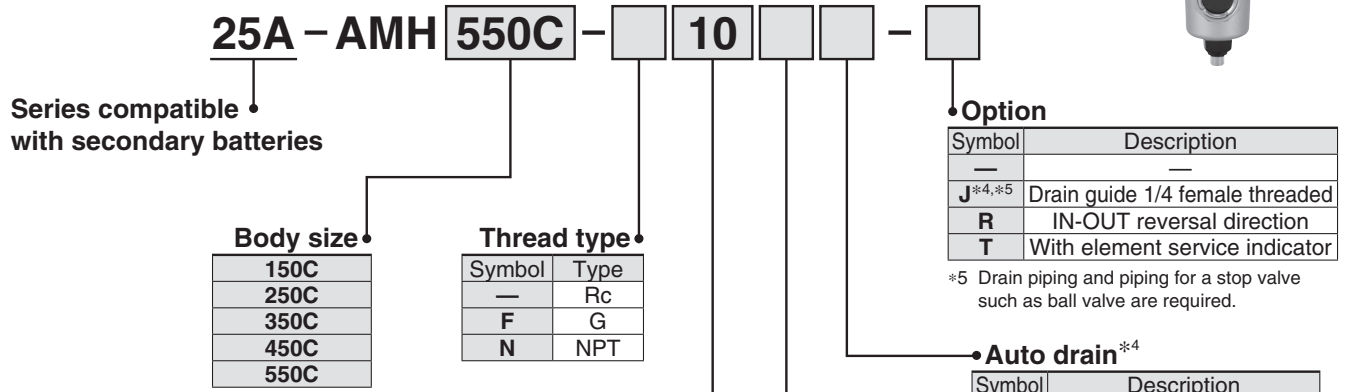

### Bracket Assembly Part Nos.\*3

Applicable model	Part no.
25A-AMH150C	25A-AMBM101
25A-AMH250C	25A-AMBM102
25A-AMH350C	25A-AMBM103
25A-AMH450C	25A-AMBM104
25A-AMH550C	25A-AMBM105

\*3 Assembly of a bracket and 2 mounting screws

### Port size

Symbol	Size	Applicable body size				
		150C	250C	350C	450C	550C
01	1/8	●	—	—	—	—
02	1/4	●	●	—	—	—
03	3/8	—	●	●	—	—
04	1/2	—	—	●	●	—
06	3/4	—	—	—	●	●
10	1	—	—	—	—	●

### Accessory

Symbol	Description
—	—
B	Bracket *1

\*1 When symbol "B" is indicated, a bracket assembly with a part number shown in the left table is shipped together as an accessory, (but not assembled).

### 25A-AMH650/850

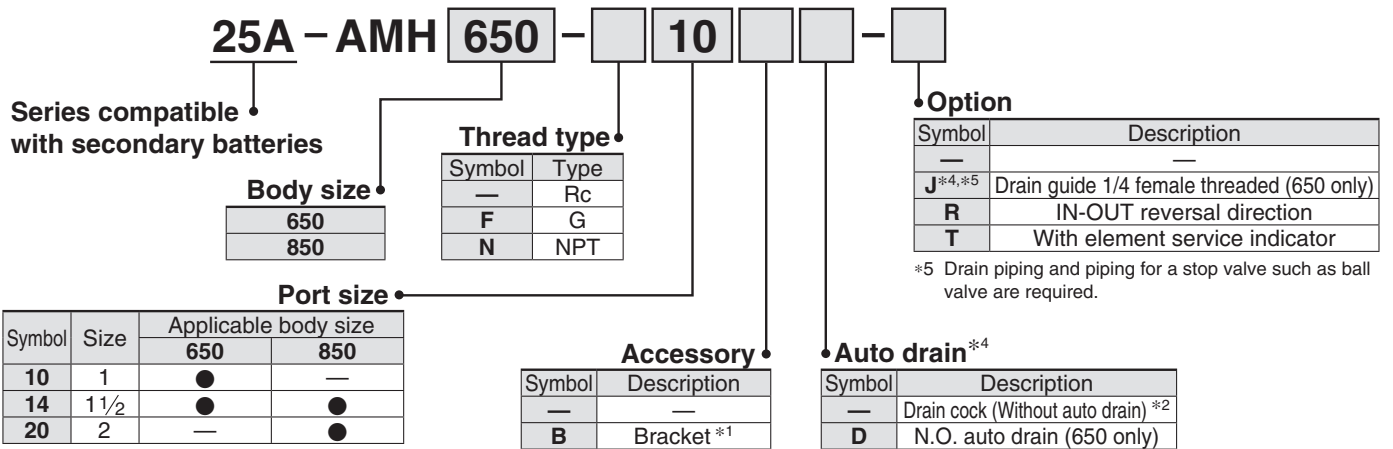

### Bracket Assembly Part Nos.\*3

Applicable model	Part no.
25A-AMH650	25A-BM56
25A-AMH850	25A-BM57

\*3 Assembly of a bracket and 2 mounting screws

\* The 25A- series specifications and dimensions are the same as those of the standard model.

# Exhaust Cleaner for Clean Room

## 25A-AMP Series

RoHS



### How to Order

25A - AMP 2 20 - 03 - -

Series compatible with secondary batteries

Size

2
3
4

Thread type

Symbol	Type
—	Rc
N	NPT
F	G

Port size

Symbol	Port size	Size		
		2	3	4
02	1/4	●	—	—
03	3/8	●	●	—
04	1/2	—	●	●
06	3/4	—	—	●

Semi-standard specifications

Symbol	Description
—	None
R	Flow direction Right→Down*3
T	With element service indicator

\*3 Flow direction when the nameplate is viewed from the front. Indicate RT when combining.

Accessories

Symbol	Name
—	None
B	With bracket*1

\*1 When symbol "B" is indicated, a bracket assembly with a part number shown in the left table is shipped together as an accessory, (but not assembled).

#### Bracket Assembly Part Nos.\*2

Applicable model	Part no.
25A-AMP220	25A-BM66
25A-AMP320	25A-BM67
25A-AMP420	25A-BM68

\*2 Assembly of a bracket and 2 mounting screws

\* The 25A- series specifications and dimensions are the same as those of the standard model.

# Air Filter

# 25A-AF20-A to 25A-AF60-A



## How to Order

25A - AF **30** - **03** **B** - **A**

① ② ③ ④ ⑤

• Series compatible with secondary batteries

- Option/Semi-standard: Select one each for **a** to **c**.
- Option/Semi-standard symbol: When more than one specification is required, indicate in alphanumeric order.  
Example) 25A-AF30-N03B-RZ-A

		Symbol	Description	① Body size				
				20	30	40	50	60
②	Pipe thread type	—	Rc	●	●	●	●	●
		N	NPT	●	●	●	●	●
		F	G	●	●	●	●	●
③	Port size	01	1/8	●	—	—	—	—
		02	1/4	●	●	●	—	—
		03	3/8	—	●	●	—	—
		04	1/2	—	—	●	—	—
		06	3/4	—	—	●	●	—
		10	1	—	—	—	●	●
④ Option	a Mounting	—	Without mounting option	●	●	●	●	●
		B*1	With bracket	●	●	●	●	●
⑤ Semi-standard	b Flow direction	—	Flow direction: Left to right	●	●	●	●	●
		R	Flow direction: Right to left	●	●	●	●	●
	c Pressure unit	—	Name plate and caution plate for bowl in SI units: MPa	●	●	●	●	●
Z*2		Name plate and caution plate for bowl in imperial units: psi, °F	○*2	○*2	○*2	○*2	○*2	

\*1 A bracket is not assembled and supplied loose at the time of shipment. Including 2 mounting screws.

\*2 ○ : For pipe thread type: NPT.

\* The 25A- series specifications and dimensions are the same as those of the standard model.

### Bracket, Bowl Assembly Part Nos. for the 25A- Series

Option \ Model	25A-AF20-A	25A-AF30-A	25A-AF40-A	25A-AF40-06-A	25A-AF50-A 25A-AF60-A
<b>Bracket assembly</b> *1	25A-AF22P-050AS	25A-AF32P-050AS	25A-AF42P-050AS	25A-AF42P-070AS	25A-AF52P-050AS
<b>Bowl assembly</b>	25A-C2SF-A	25A-C3SF-A	25A-C4SF-A		

\*1 Assembly of a bracket and 2 mounting screws.

# Air Filter

# 25A-AF20-D to 25A-AF60-D



## How to Order

25A - AF **30** - **03** **B** - **D**

① ② ③ ④ ⑤

Series compatible with secondary batteries

- Option/Semi-standard: Select one each for **a** to **c**.
- Option/Semi-standard symbol: When more than one specification is required, indicate in alphanumeric order.  
Example) 25A-AF30-N03B-RZ-D

		Symbol	Description	① Body size				
				20	30	40	50	60
②	Pipe thread type	—	Rc	●	●	●	●	●
		N	NPT	●	●	●	●	●
		F	G	●	●	●	●	●
③	Port size	01	1/8	●	—	—	—	—
		02	1/4	●	●	●	—	—
		03	3/8	—	●	●	—	—
		04	1/2	—	—	●	—	—
		06	3/4	—	—	●	●	—
		10	1	—	—	—	●	●
④ Option	a Mounting	—	Without mounting option	●	●	●	●	●
		B*1	With bracket	●	●	●	●	●
⑤ Semi-standard	b Flow direction	—	Flow direction: Left to right	●	●	●	●	●
		R	Flow direction: Right to left	●	●	●	●	●
	c Unit	—	Unit on product label: MPa, °C	●	●	●	●	●
		Z*2	Unit on product label: psi, °F	○*2	○*2	○*2	○*2	○*2

\*1 Option B is included in the package with the product but does not come assembled. The assembly consists of 2 types of the bracket and 2 mounting screws.

\*2 ○ : For pipe thread type: NPT.

\* The 25A- series specifications and dimensions are the same as those of the standard model.

### Bracket, Bowl Assembly Part Nos. for the 25A- Series

Option	Model					
	AF20-D	AF30-D	AF40-D	AF40-06-D	AF50-D	AF60-D
Bracket assembly*1	25A-AF24P-070AS	25A-AF34P-070AS	25A-AF44P-070AS	25A-AF49P-070AS	25A-AF54P-070AS	
Bowl assembly	25A-C2SF-D	25A-C3SF-D	25A-C4SF-D			

\*1 The assembly consists of a bracket A/B and 2 mounting screws.

# Mist Separator

# 25A-AFM20-A to 25A-AFM40-A

## Micro Mist Separator

# 25A-AFD20-A to 25A-AFD40-A



- 25A-AFM Series Nominal filtration rating: 0.3 μm
- 25A-AFD Series Nominal filtration rating: 0.01 μm

### How to Order

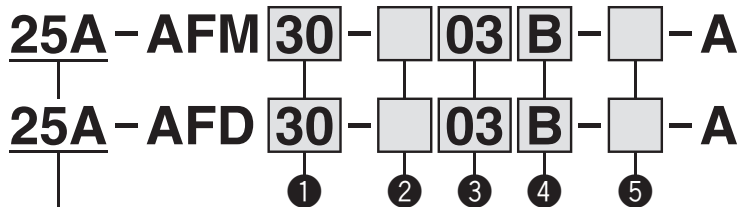

• Series compatible with secondary batteries

- Option/Semi-standard: Select one each for a to c.
- Option/Semi-standard symbol: When more than one specification is required, indicate in alphanumeric order. Example) 25A-AFM30-N03B-RZ-A

	Symbol	Description	①				
			Body size				
			20	30	40		
②	Pipe thread type	—	Rc	●	●	●	
		N	NPT	●	●	●	
		F	G	●	●	●	
+							
③	Port size	01	1/8	●	—	—	
		02	1/4	●	●	●	
		03	3/8	—	●	●	
		04	1/2	—	—	●	
		06	3/4	—	—	●	
+							
④	Option a	Mounting	—	Without mounting option	●	●	●
			B*1	With bracket	●	●	●
+							
⑤	Semi-standard b	Flow direction	—	Flow direction: Left to right	●	●	●
			R	Flow direction: Right to left	●	●	●
+							
⑤	Semi-standard c	Pressure unit	—	Name plate and caution plate for bowl in SI units: MPa	●	●	●
			Z*2	Name plate and caution plate for bowl in imperial units: psi, °F	○*2	○*2	○*2

\*1 A bracket is not assembled and supplied loose at the time of shipment. Including 2 mounting screws.

\*2 ○ : For pipe thread type: NPT.

\* The 25A- series specifications and dimensions are the same as those of the standard model.

### Bracket, Bowl Assembly Part Nos. for the 25A- Series

Option	Model	25A-AFM20-A 25A-AFD20-A	25A-AFM30-A 25A-AFD30-A	25A-AFM40-A 25A-AFD40-A	25A-AFM40-06-A 25A-AFD40-06-A
<b>Bracket assembly</b> *1		25A-AF22P-050AS	25A-AF32P-050AS	25A-AF42P-050AS	25A-AF42P-070AS
<b>Bowl assembly</b>		25A-C2SF-A	25A-C3SF-A	25A-C4SF-A	

\*1 Assembly of a bracket and 2 mounting screws.

# Mist Separator

## 25A-AFM20-D to 25A-AFM40-06-D

### Micro Mist Separator

## 25A-AFD20-D to 25A-AFD40-06-D



- 25A-AFM Series Nominal filtration rating: 0.3 μm
- 25A-AFD Series Nominal filtration rating: 0.01 μm

### How to Order

25A - AFM **30** - **03** **B** - **D**

25A - AFD **30** - **03** **B** - **D**

① ② ③ ④ ⑤

• Series compatible with secondary batteries

- Option/Semi-standard: Select one each for a to c.
- Option/Semi-standard symbol: When more than one specification is required, indicate in alphanumeric order. Example) 25A-AFM30-N03B-RZ-D

	Symbol	Description	①			
			Body size			
			20	30	40	
②	—	Rc	●	●	●	
	N	NPT	●	●	●	
	F	G	●	●	●	
+						
③	01	1/8	●	—	—	
	02	1/4	●	●	●	
	03	3/8	—	●	●	
	04	1/2	—	—	●	
	06	3/4	—	—	●	
+						
④	a	—	Without mounting option	●	●	●
		B*1	With bracket	●	●	●
+						
⑤	b	—	Flow direction: Left to right	●	●	●
		R	Flow direction: Right to left	●	●	●
+						
⑤	c	—	Unit on product label: MPa, °C	●	●	●
		Z*2	Unit on product label: psi, °F	○*2	○*2	○*2

\*1 Option B is included in the package with the product but does not come assembled. The assembly consists of 2 types of the bracket and 2 mounting screws.

\*2 ○ : For pipe thread type: NPT. This product is for overseas use only according to the New Measurement Law.  
(The SI unit type is provided for use in Japan.)

\* The 25A- series specifications and dimensions are the same as those of the standard model.

### Bracket, Bowl Assembly Part Nos. for the 25A- Series

Option	Model			
	25A-AFM20-D 25A-AFD20-D	25A-AFM30-D 25A-AFD30-D	25A-AFM40-D 25A-AFD40-D	25A-AFM40-06-D 25A-AFD40-06-D
<b>Bracket assembly*1</b>	25A-AF24P-070AS	25A-AF34P-070AS	25A-AF44P-070AS	25A-AF49P-070AS
<b>Bowl assembly</b>	25A-C2SF-D	25A-C3SF-D	25A-C4SF-D	

\*1 The assembly consists of a bracket A/B and 2 mounting screws.



# Regulator

# 25A-AR20-B to 25A-AR60-B

## Regulator with Backflow Function

# 25A-AR20K-B to 25A-AR60K-B



### How to Order

**25A-AR** 30 K -   03 B -   - **B**

1
2
3
4
5
6

• Series compatible with secondary batteries

- Option/Semi-standard: Select one each for a to f.
- Option/Semi-standard symbol: When more than one specification is required, indicate in alphanumeric order. Example) 25A-AR30K-03B-1NR-B

	Symbol	Description	①						
			Body size						
			20	25	30	40	50	60	
② With backflow function	—	Without backflow function	●	●	●	●	●	●	
	<b>K</b>	With backflow function	●	●	●	●	●	●	
+									
③ Pipe thread type	—	Rc	●	●	●	●	●	●	
	<b>N</b>	NPT	●	●	●	●	●	●	
	<b>F</b>	G	●	●	●	●	●	●	
+									
④ Port size	<b>01</b>	1/8	●	—	—	—	—	—	
	<b>02</b>	1/4	●	●	●	●	—	—	
	<b>03</b>	3/8	—	●	●	●	—	—	
	<b>04</b>	1/2	—	—	—	●	—	—	
	<b>06</b>	3/4	—	—	—	●	●	—	
<b>10</b>	1	—	—	—	—	●	●		
+									
⑤ Option*1	a Mounting	—	Without mounting option	●	●	●	●	●	●
		<b>B</b> *2	With bracket	●	●	●	●	●	●
		<b>H</b>	With set nut (For panel fitting)	●	●	●	●	—	—
+									
	b Set pressure	—	0.05 to 0.85 MPa setting	●	●	●	●	●	●
		<b>1</b> *3	0.02 to 0.2 MPa setting	●	●	●	●	●	●
+									
	c Exhaust mechanism	—	Relieving type	●	●	●	●	●	●
		<b>N</b>	Non-relieving type	●	●	●	●	●	●
+									
	d Flow direction	—	Flow direction: Left to right	●	●	●	●	●	●
		<b>R</b>	Flow direction: Right to left	●	●	●	●	●	●
+									
	e Knob	—	Downward	●	●	●	●	●	●
		<b>Y</b>	Upward	●	●	●	●	●	●
+									
⑥ Semi-standard	f Pressure unit	—	Name plate in SI units: MPa	●	●	●	●	●	●
		<b>Z</b> *4	Name plate in imperial units: psi	○*4	○*4	○*4	○*4	○*4	○*4

\*1 Option "B", "H" are not assembled and supplied loose at the time of shipment.

\*2 Assembly of a bracket and set nuts (25A-AR20(K) to 25A-AR40(K)). Including 2 mounting screws for the 25A-AR50(K) and 25A-AR60(K).

\*3 Pressure can be set at the upper limit of the specification or more, however, be sure to set the pressure within specification.

\*4 ○: For pipe thread type: NPT.

\* The 25A- series specifications and dimensions are the same as those of the standard model.

### Bracket, Set Nut Part Nos. for the 25A- Series

Option \ Model	25A-AR20(K)-B	25A-AR25(K)-B	25A-AR30(K)-B	25A-AR40(K)-B	25A-AR50(K)-B 25A-AR60(K)-B
<b>Bracket assembly</b> *1	25A-AR23P-270AS	25A-AR28P-270AS	25A-AR33P-270AS	25A-AR43P-270AS	25A-AR52P-270AS*2
<b>Set nut</b>	AR23P-260S	AR28P-260S	AR33P-260S	AR43P-260S	—*3

\*1 Assembly of a bracket and set nuts.

\*2 Assembly of a bracket and 2 mounting screws.

\*3 Please consult with SMC regarding the set nuts for the 25A-AR50(K) and 25A-AR60(K).

# Regulator

# 25A-AR20-D to 25A-AR60-D

## Regulator with Backflow Function

# 25A-AR20K-D to 25A-AR60K-D



### How to Order

**25A-AR** 30 K -   03 B -   - **D**

1
2
3
4
5
6

Series compatible with secondary batteries

- Option/Semi-standard: Select one each for a to f.
- Option/Semi-standard symbol: When more than one specification is required, indicate in alphanumeric order. Example) 25A-AR30K-03B-1NR-D

	Symbol	Description	①							
			Body size							
			20	30	40	50	60			
②	—	Without backflow function	●	●	●	●	●			
	K*1	With backflow function	●	●	●	●	●			
+										
③	—	Rc	●	●	●	●	●			
	N	NPT	●	●	●	●	●			
	F	G	●	●	●	●	●			
+										
④	01	1/8	●	—	—	—	—			
	02	1/4	●	●	●	—	—			
	03	3/8	—	●	●	—	—			
	04	1/2	—	—	●	—	—			
	06	3/4	—	—	●	●	—			
10	1	—	—	—	●	●				
+										
⑤	a	Mounting	—	Without mounting option		●	●	●	●	●
			B*3	With bracket		●	●	●	●	●
			H	With set nut (For panel fitting)		●	●	●	—	—
+										
⑥	b	Set pressure	—	0.05 to 0.85 MPa setting		●	●	●	●	●
			1*4	0.02 to 0.2 MPa setting		●	●	●	●	●
+										
⑥	c	Exhaust mechanism	—	Relieving type		●	●	●	●	●
			N	Non-relieving type		●	●	●	●	●
+										
⑥	d	Flow direction	—	Flow direction: Left to right		●	●	●	●	●
			R	Flow direction: Right to left		●	●	●	●	●
+										
⑥	e	Knob	—	Downward		●	●	●	●	●
			Y	Upward		●	●	●	●	●
+										
⑥	f	Unit	—	Unit on product label: MPa, Pressure gauge in SI units: MPa		●	●	●	●	●
			Z*5	Unit on product label: psi, Pressure gauge: MPa/psi dual scale		○*5	○*5	○*5	○*5	○*5

\*1 Set the inlet pressure to at least 0.05 MPa higher than the set pressure.

\*2 Option "B", "H" are not assembled and supplied loose at the time of shipment.

\*3 Assembly of a bracket and set nuts.

\*4 Pressure can be set at the upper limit of the specification or more, however, be sure to set the pressure within specification.

\*5 ○: For pipe thread type: NPT. This product is for overseas use only according to the New Measurement Law. (The SI unit type is provided for use in Japan.)

\* The 25A- series specifications and dimensions are the same as those of the standard model.

### Bracket, Set Nut Part Nos. for the 25A- Series

Option	Model					
	25A-AR20(K)-D	25A-AR30(K)-D	25A-AR40(K)-D	25A-AR40(K)-06-D	25A-AR50(K)-D	25A-AR60(K)-D
Bracket assembly*1	25A-AR23P-270AS	25A-AR33P-270AS	25A-AR43P-270AS		25A-AR54P-270AS	
Set nut	AR23P-260S	AR33P-260S	AR43P-260S		—*2	

\*1 Assembly of a bracket and set nuts. For the 25A-AR50(K)-D and 25A-AR60(K)-D, the assembly consists of a bracket A/B and 2 mounting screws.

\*2 Please contact SMC regarding the set nuts for the 25A-AR50(K)-D and 25A-AR60(K)-D.

# Filter Regulator

# 25A-AW20-B to 25A-AW60-B

## Filter Regulator with Backflow Function

# 25A-AW20K-B to 25A-AW60K-B



### How to Order

**25A - AW** 30 K -   03 B -   - **B**

① ② ③ ④ ⑤ ⑥

• Series compatible with secondary batteries

• Option/Semi-standard: Select one each for a to e.  
 • Option/Semi-standard symbol: When more than one specification is required, indicate in alphanumeric order.  
 Example) 25A-AW30K-03B-1N-B

		Symbol	Description	①					
				Body size					
				20	30	40	60		
②	With backflow function	—	Without backflow function	●	●	●	●		
		<b>K</b>	With backflow function	●	●	●	●		
+									
③	Pipe thread type	—	Rc	●	●	●	●		
		<b>N</b>	NPT	●	●	●	●		
		<b>F</b>	G	●	●	●	●		
+									
④	Port size	<b>01</b>	1/8	●	—	—	—		
		<b>02</b>	1/4	●	●	●	—		
		<b>03</b>	3/8	—	●	●	—		
		<b>04</b>	1/2	—	—	●	—		
		<b>06</b>	3/4	—	—	●	●		
		<b>10</b>	1	—	—	—	●		
+									
⑤	Option a	Mounting	—	Without mounting option	●	●	●	●	
			<b>B</b> *2	With bracket	●	●	●	●	
			<b>H</b>	With set nut (For panel fitting)	●	●	●	—	
+									
⑥	Semi-standard b	Set pressure	—	0.05 to 0.85 MPa setting	●	●	●	●	
			<b>1</b> *3	0.02 to 0.2 MPa setting	●	●	●	●	
		+							
		c	Exhaust mechanism	—	Relieving type	●	●	●	●
				<b>N</b>	Non-relieving type	●	●	●	●
		+							
d	Flow direction	—	Flow direction: Left to right	●	●	●	●		
		<b>R</b>	Flow direction: Right to left	●	●	●	●		
+									
e	Pressure unit	—	Name plate and caution plate for bowl in SI units: MPa	●	●	●	●		
		<b>Z</b> *4	Name plate and caution plate for bowl in imperial units: psi, °F	○*4	○*4	○*4	○*4		

\*1 Option "B", "H" are not assembled and supplied loose at the time of shipment.

\*2 Assembly of a bracket and set nuts (25A-AW20(K) to 25A-AW40(K)). Including 2 mounting screws for the 25A-AW60(K).

\*3 Pressure can be set at the upper limit of the specification or more, however, be sure to set the pressure within specification.

\*4 ○ : For pipe thread type: NPT. This product is for overseas use only according to the New Measurement Law.  
 (The SI unit type is provided for use in Japan.)

\* The 25A- series specifications and dimensions are the same as those of the standard model.

### Bracket, Set Nut, Bowl Assembly Part Nos. for the 25A- Series

Model	25A-AW20(K)-B	25A-AW30(K)-B	25A-AW40(K)-B	25A-AW60(K)-B
Option				
<b>Bracket assembly</b> *1	25A-AW23P-270AS	25A-AR33P-270AS	25A-AR43P-270AS	25A-AW62P-270AS*2
<b>Set nut</b>	AR23P-260S	AR33P-260S	AR43P-260S	—*3
<b>Bowl assembly</b>	25A-C2SF-A	25A-C3SF-A	25A-C4SF-A	

\*1 Assembly of a bracket and set nuts.

\*2 Assembly of a bracket and 2 mounting screws.

\*3 Please consult with SMC regarding the set nuts for the 25A-AW60(K).

# Filter Regulator

# 25A-AW20-D to 25A-AW60-D

## Filter Regulator with Backflow Function

# 25A-AW20K-D to 25A-AW60K-D



### How to Order

**25A - AW** 30 K -   03 B -   - **D**

① ② ③ ④ ⑤ ⑥

• Series compatible with secondary batteries

• Option/Semi-standard: Select one each for a to e.  
 • Option/Semi-standard symbol: When more than one specification is required, indicate in alphanumeric order.  
 Example) 25A-AW30K-03B-1N-D

		Symbol	Description	①					
				Body size					
				20	30	40	60		
②	With backflow function	—	Without backflow function	●	●	●	●		
		K*1	With backflow function	●	●	●	●		
+									
③	Pipe thread type	—	Rc	●	●	●	●		
		N	NPT	●	●	●	●		
		F	G	●	●	●	●		
+									
④	Port size	01	1/8	●	—	—	—		
		02	1/4	●	●	●	—		
		03	3/8	—	●	●	—		
		04	1/2	—	—	●	—		
		06	3/4	—	—	●	●		
		10	1	—	—	—	●		
+									
⑤	Option*2 a	Mounting	—	Without mounting option	●	●	●	●	
			B*3	With bracket	●	●	●	●	
			H	With set nut (For panel fitting)	●	●	●	—	
+									
⑥	Semi-standard	b	Set pressure	—	0.05 to 0.85 MPa setting	●	●	●	●
				1*4	0.02 to 0.2 MPa setting	●	●	●	●
		+							
		c	Exhaust mechanism	—	Relieving type	●	●	●	●
				N	Non-relieving type	●	●	●	●
		+							
d	Flow direction	—	Flow direction: Left to right	●	●	●	●		
		R	Flow direction: Right to left	●	●	●	●		
+									
e	Unit	—	Unit on product label: MPa, °C, Pressure gauge in SI units: MPa	●	●	●	●		
		Z*5	Unit on product label: psi, °F, Pressure gauge: MPa/psi dual scale	○*5	○*5	○*5	○*5		

\*1 Set the inlet pressure to at least 0.05 MPa higher than the set pressure.

\*2 Option "B", "H" are not assembled and supplied loose at the time of shipment.

\*3 Assembly of a bracket and set nuts.

\*4 Pressure can be set at the upper limit of the specification or more, however, be sure to set the pressure within specification.

\*5 ○ : For pipe thread type: NPT. This product is for overseas use only according to the New Measurement Law.

(The SI unit type is provided for use in Japan.)

\* The 25A- series specifications and dimensions are the same as those of the standard model.

### Bracket, Set Nut, Bowl Assembly Part Nos. for the 25A- Series

Option	Model				
	25A-AW20(K)-D	25A-AW30(K)-D	25A-AW40(K)-D	25A-AW40(K)-06-D	25A-AW60(K)-D
<b>Bracket assembly</b> *1	25A-AW23P-270AS	25A-AR33P-270AS	25A-AR43P-270AS		25A-AR54P-270AS
<b>Set nut</b>	AR23P-260S	AR33P-260S	AR43P-260S		—*2
<b>Bowl assembly</b>	25A-C2SF-D	25A-C3SF-D	25A-C4SF-D		

\*1 Assembly of a bracket and set nuts.

\*2 For the 25A-AW60(K)-D, the assembly consists of a bracket A/B and 2 mounting screws. Please contact SMC regarding the set nuts for the 25A-AW60(K)-D.

# Precision Regulator



# 25A-IR1000/2000/3000-A Series

## How to Order



25A-IR 1 0 0 0 -   01 B -   - A

1  
 2  
 3  
 4  
 5  
 6  
 7

- Option/Semi-standard: Select one each for **a**, **b**, and **c**.
- Option/Semi-standard symbol: When more than one specification is required, indicate in alphanumeric order.

		Symbol	Description	①			
				Body size			
				1	2	3	
②	Set pressure range	0	0.005 to 0.2 MPa	●	●	—	
		1	0.01 to 0.2 MPa	—	—	●	
		2	0.01 to 0.4 MPa	●	●	●	
		2	0.01 to 0.8 MPa	●	●	●	
		+					
③	Exhaust direction	0	Bottom exhaust	●	●	●	
		1	Front exhaust	—	—	●	
		2	Rear exhaust	—	—	●	
		+					
④	Pipe thread type	—	Rc	●	●	●	
		N	NPT	●	●	●	
		F	G	●	●	●	
		+					
⑤	Port size	01	1/8	●	—	—	
		02	1/4	—	●	●	
		03	3/8	—	—	●	
		04	1/2	—	—	●	
		+					
⑥	*1 Option a	Mounting	—	Without mounting option	●	●	●
			B*2	With bracket	●	●	●
			H	With hexagon panel nut (for panel mount)	●	●	●
		+					
⑦	Semi-standard b	Flow direction	—	Flow direction: Left to right	●	●	●
			R	Flow direction: Right to left	●	●	●
			+				
⑦	Semi-standard c	Knob	—	Upward	●	●	●
			V	Downward	●	●	●

\*1 Options are shipped together with the product, but not assembled. B and H cannot be selected at the same time. The current bracket cannot be used for this product.

\*2 Assembly of a bracket and set nuts

# Electro-Pneumatic Regulator

## 25A-ITV1000/2000/3000 Series



### How to Order

Series compatible with secondary batteries

25A-ITV **2** **0** **1** **0** - **0** **1** **2** **S**

**Model**

1	1000 type
2	2000 type
3	3000 type

**Pressure range**

1	0.1 MPa
3	0.5 MPa
5	0.9 MPa

**Power supply voltage**

0	24 VDC
1	12 to 15 VDC

**Input signal**

0	Current type 4 to 20 mA DC (Sink type)
1	Current type 0 to 20 mA DC (Sink type)
2	Voltage type 0 to 5 VDC
3	Voltage type 0 to 10 VDC
40	4 points preset input

**Monitor output**

1	Analogue output 1 to 5 VDC
2	Switch output/NPN output
3	Switch output/PNP output
4	Analogue output 4 to 20 mA DC (Sink type)
—	None (For 4 points preset input)

**Pressure display unit**

—	MPa
2*1	kgf/cm <sup>2</sup>
3	bar
4*1	psi
5	kPa

**Cable connector type**

S	Straight type 3 m
L	Right angle type 3 m
N	Without cable connector

\* A dedicated cable connector whose material was changed is used.

**Bracket**

—	Without bracket
B	Flat bracket
C	L-bracket

\* The bracket is made with a special black chromium treatment. The bracket is shipped with the product.

**Port size**

1	1/8 (1000 type)
2	1/4 (1000, 2000, 3000 type)
3	3/8 (2000, 3000 type)
4	1/2 (3000 type)

**Thread type**

—	Rc
N	NPT
T	NPTF
F	G

\* Since the lead wires and electrical circuits are used, this product is not completely copper-free. Only the wetted parts are copper-free.

\* Copper and zinc materials are used for solenoid valve coils, connector pins, and lead wire substrate.

\* The 25A- series specifications and dimensions are the same as those of the standard model.

# Booster Regulator 25A-VBA Series



## How to Order

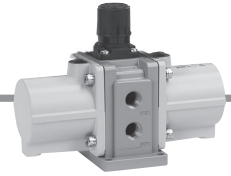

25A - VBA 40A - [ ] 04 [ ]

Series compatible with secondary batteries

Body size	Pressure increase ratio
10A	1/4", Handle-operated type
20A	3/8", Handle-operated type
40A	1/2", Handle-operated type

Pressure increase ratio: Twice

Thread type\*1

Symbol	Thread type
—	Rc
F	G
N	NPT
T	NPTF

\*1 Thread types apply to the IN, OUT, and EXH ports of the VBA10A and to the IN, OUT, EXH, and gauge ports of the VBA20A and VBA40A. The gauge ports of the VBA10A are Rc thread type regardless of the thread type indication.

Port size

Symbol	Port size	Applicable series
02	1/4	VBA10A
03	3/8	VBA20A
04	1/2	VBA40A

Option

Symbol	Option
—	None
N	Silencer
S	High-noise reduction silencer*1
LN	Elbow silencer*1
LS	Elbow high-noise reduction silencer*1

\*1 Refer to "Combination of Thread Type and Options."  
\* Pressure gauge is not available as an option.

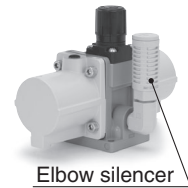
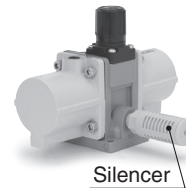

## Combination of Thread Type and Options

Body size	Thread type	Option					Semi-standard
		—	N	S	LN	LS	
10A	—	●	●	●	●	●	●
	F	●	●	●	●	●	●
	N	●	●	—	●	—	●
	T	●	●	—	●	—	●
20A	—	●	●	●	/	/	●
	F	●	●	●			●
	N	●	●	●			●
	T	●	●	●			●
40A	—	●	●	●	/	/	●
	F	●	●	●			●
	N	●	●	●			●
	T	●	●	●			●

## Caution

- Not compatible with a low dew point
- VBA10A: Due to the close proximity of the IN and OUT sides of the gauge port and the handle of the booster regulator, a G43-10-01-X300/G46-SRB pressure gauge cannot be mounted as it will interfere with the handle.  
VBA20A/40A: The G43-10-01-X300/G46-SRB pressure gauge cannot be mounted as the mounting pitch of the IN and OUT sides of the gauge port of the booster regulator is smaller than the diameter of the pressure gauge. In order to mount the pressure gauge, piping which does not cause any interference must be prepared separately.

## Air Tank Compatibility Chart

Air tank	Booster regulator		
	25A-VBA10A	25A-VBA20A	25A-VBA40A
25A-VBAT05A1	●	—	—
25A-VBAT05S1	●	—	—
25A-VBAT10A1	●	●	—
25A-VBAT10S1	●	●	—
25A-VBAT20A1	—	●	●
25A-VBAT20S1	—	●	●
25A-VBAT38A1	—	●	●
25A-VBAT38S1	—	●	●

\* Refer to page 167 for details on air tanks.

\* The 25A- series specifications and dimensions are the same as those of the standard model.





# Quick Exhaust Valve with One-touch Fittings

RoHS

# 25A-AQ240F/340F Series



## How to Order

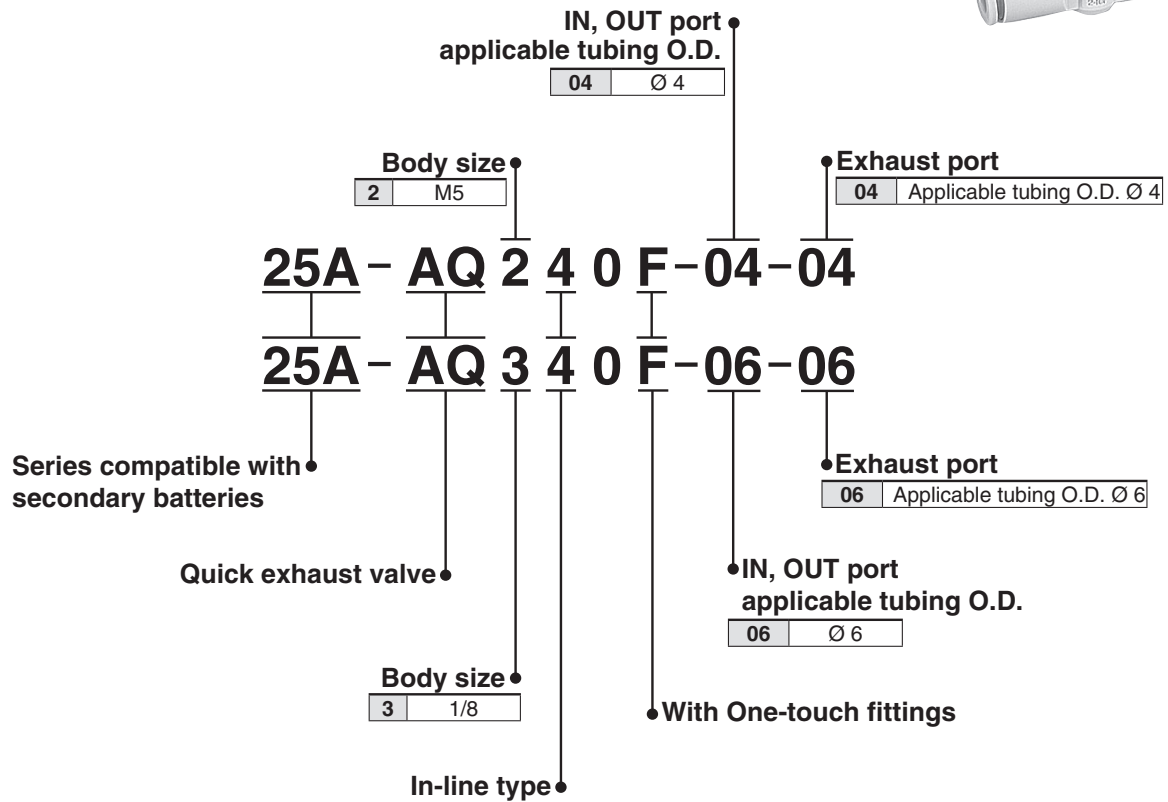

\* The 25A- series specifications and dimensions are the same as those of the standard model.

# Check Valve with One-touch Fittings **25A-AKH Series**



## How to Order



**Straight type**

**25A - AKH 04 - 00**

Series compatible with  
secondary batteries

Applicable tubing O.D.  
Metric size

04	Ø 4
06	Ø 6
08	Ø 8
10	Ø 10
12	Ø 12

\* The 25A- series specifications and dimensions are the same as those of the standard model.

# Rectangular Multi-connector

# **25A-KDM Series**

No. of Connecting Tubes: 20

RoHS

## How to Order

**25A - KDM 20 - 06**

Series compatible with secondary batteries

No. of connecting tubes

Tubing O.D.

Metric size

Symbol	Size	Colour of release button
23	Ø 3.2	Blue
04	Ø 4	
06	Ø 6	

Inch size

Symbol	Size	Colour of release button
01	Ø 1/8"	Red
03	Ø 5/32"	
07	Ø 1/4"	

### Applicable Tubing

Tubing material	FEP, PFA, Nylon, Soft nylon, Polyurethane
-----------------	---

\* The 25A- series specifications and dimensions are the same as those of the standard model.

1 Output

# 3-Screen Display High-Precision Digital Pressure Switch

# 25A-ZSE20(F)/ISE20 Series



RoHS

IP40



## How to Order

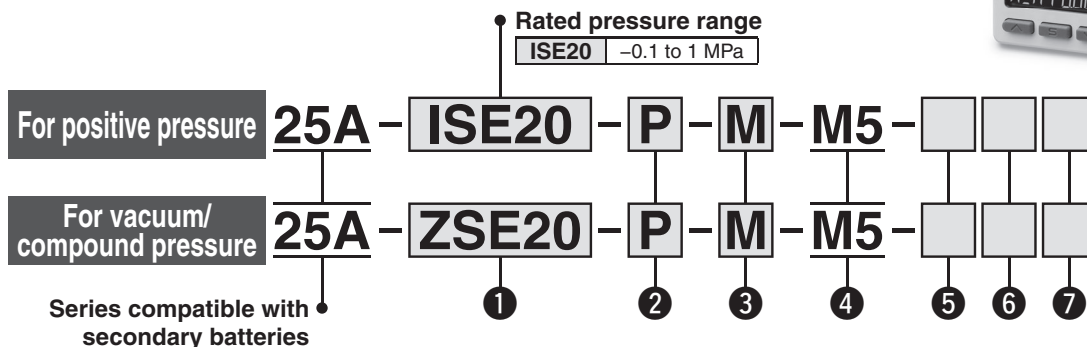

### ① Rated pressure range

Symbol	Description
ZSE20	0 to -101 kPa
ZSE20F	-100 to 100 kPa

### ② Output specification

Symbol	Description
N	NPN open collector 1 output
P	PNP open collector 1 output

### ③ Unit specification

Symbol	Description
—	Units selection function
M	SI unit only*1
P	Units selection function (Initial value psi)

\*1 Fixed unit: kPa, MPa

### ④ Piping specification

Symbol	Description
M5	M5 female thread

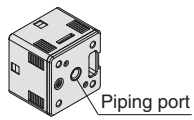

### ⑤ Option 1

Symbol	Description
—	Without lead wire
L	Lead wire with connector (3-core, 2 m lead wire)

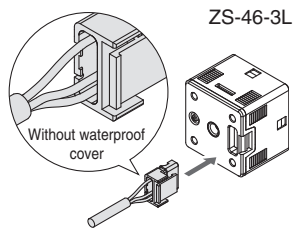

### ⑦ Option 3

Symbol	Operation manual*1	Calibration certificate*1
—	○	—
Y	—	—
K	○	○
T	—	○

\*1 All texts are in both English and Japanese.

### ⑥ Option 2

Symbol	Description
—	None
B	Panel mount adapter
D	Panel mount adapter + Front protection cover

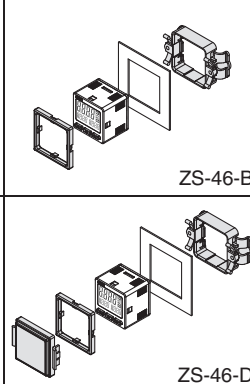

## Options/Part Nos.

When only optional parts are required, order with the part numbers listed below.

Description	Part no.	Note
Panel mount adapter	ZS-46-B	—
Panel mount adapter + Front protection cover	ZS-46-D	—
Lead wire with connector	ZS-46-3L	3-core, 2 m, Non-waterproof (Without waterproof cover)
Front protection cover	ZS-27-01	—

\* The 25A-series specifications and dimensions are the same as those of the standard model.

2 Outputs + Analogue Output (Voltage/Current)



# 3-Screen Display High-Precision Digital Pressure Switch

RoHS

IP40

# 25A-ZSE20A(F)/ISE20A Series

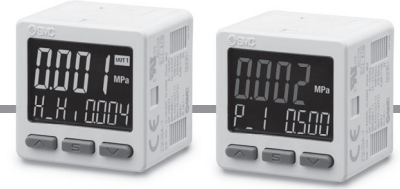

## How to Order

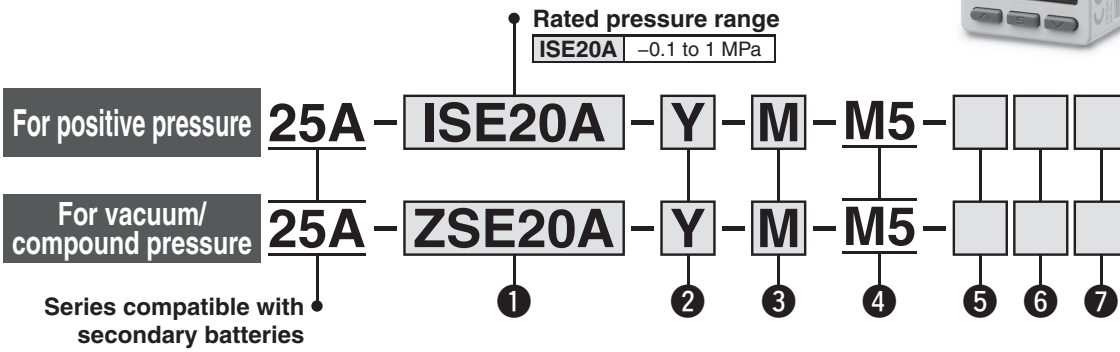

### 1 Rated pressure range

ZSE20A	0 to -101 kPa
ZSE20AF	-100 to 100 kPa

### 2 Output specification

Symbol	Description
R	NPN open collector 2 outputs + Analogue voltage output*1
S	NPN open collector 2 outputs + Analogue current output*1
T	PNP open collector 2 outputs + Analogue voltage output*1
V	PNP open collector 2 outputs + Analogue current output*1
X	NPN open collector 2 outputs + Copy function
Y	PNP open collector 2 outputs + Copy function

\*1 Can be switched to auto-shift or copy function

### 3 Unit specification

Symbol	Description
—	Units selection function
M	SI unit only*1
P	Units selection function (Initial value psi)

\*1 Fixed unit: kPa, MPa

### 4 Piping specification

Symbol	Description
M5	M5 female thread

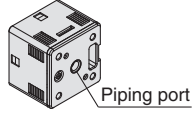

### 5 Option 1

Symbol	Description
—	Without lead wire
J	Lead wire with connector (5-core, 2 m lead wire)

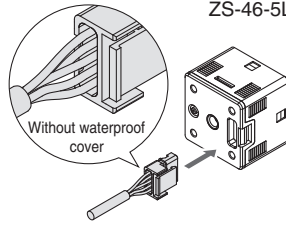

### 7 Option 3

Symbol	Operation manual*1	Calibration certificate*1
—	○	—
Y	—	—
K	○	○
T	—	○

\*1 All texts are in both English and Japanese.

### 6 Option 2

Symbol	Description
—	None
B	Panel mount adapter
D	Panel mount adapter + Front protection cover

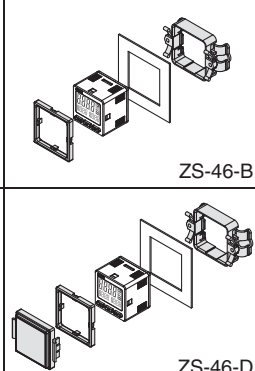

## Options/Part Nos.

When only optional parts are required, order with the part numbers listed below.

Description	Part no.	Note
Panel mount adapter	ZS-46-B	—
Panel mount adapter + Front protection cover	ZS-46-D	—
Lead wire with connector	ZS-46-5L	5-core, 2 m, Non-waterproof (Without waterproof cover)
Front protection cover	ZS-27-01	—

2 Outputs + Analogue Output (Voltage/Current)



# 3-Screen Display High-Precision Digital Pressure Switch

RoHS

IP65

# 25A-ZSE20B(F)/ISE20B Series

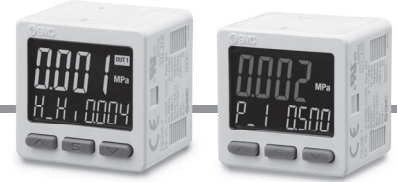

## How to Order

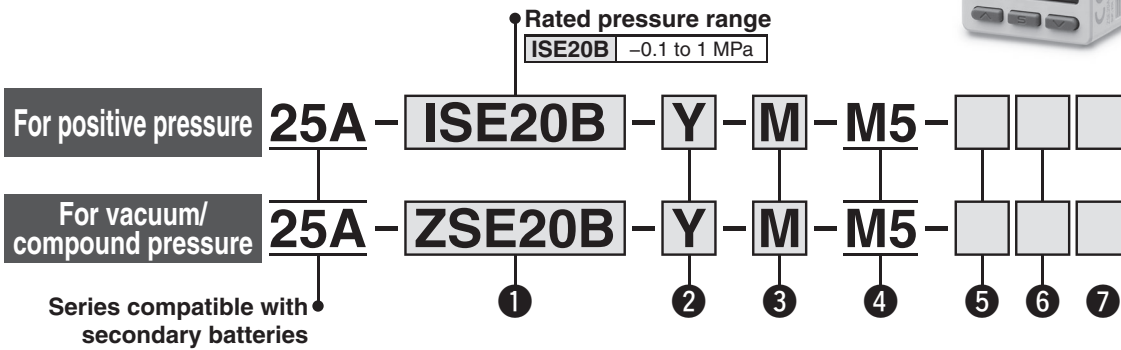

### ① Rated pressure range

ZSE20B	0 to -101 kPa
ZSE20BF	-100 to 100 kPa

### ② Output specification

Symbol	Description
R	NPN open collector 2 outputs + Analogue voltage output*1
S	NPN open collector 2 outputs + Analogue current output*1
T	PNP open collector 2 outputs + Analogue voltage output*1
V	PNP open collector 2 outputs + Analogue current output*1
X	NPN open collector 2 outputs + Copy function
Y	PNP open collector 2 outputs + Copy function

\*1 Can be switched to auto-shift or copy function

### ③ Unit specification

Symbol	Description
—	Units selection function
M	SI unit only*1
P	Units selection function (Initial value psi)

\*1 Fixed unit: kPa, MPa

### ④ Piping specification

Symbol	Description
M5	M5 female thread

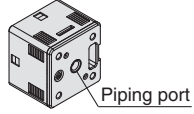

### ⑤ Option 1

Symbol	Description
—	Without lead wire
W	Lead wire with connector (5-core, 2 m lead wire, With waterproof cover)

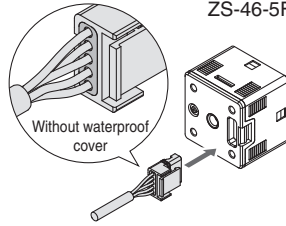

### ⑦ Option 3

Symbol	Operation manual*1	Calibration certificate*1
—	○	—
Y	—	—
K	○	○
T	—	○

\*1 All texts are in both English and Japanese.

### ⑥ Option 2

Symbol	Description
—	None
B	Panel mount adapter
D	Panel mount adapter + Front protection cover

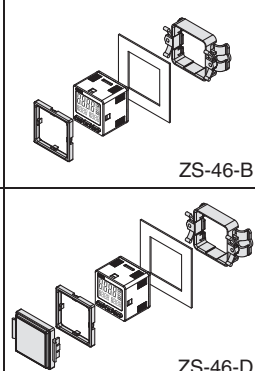

## Options/Part Nos.

When only optional parts are required, order with the part numbers listed below.

Description	Part no.	Note
Panel mount adapter	ZS-46-B	—
Panel mount adapter + Front protection cover	ZS-46-D	—
Lead wire with connector	ZS-46-5F	5-core, 2 m, Waterproof (With waterproof cover)
Front protection cover	ZS-27-01	—



2 Outputs + Analogue Output (Voltage/Current)



# 3-Screen Display High-Precision Digital Pressure Switch for General Fluids

RoHS  
IP65

# 25A-ZSE20C(F)/ISE20C(H) Series



## How to Order

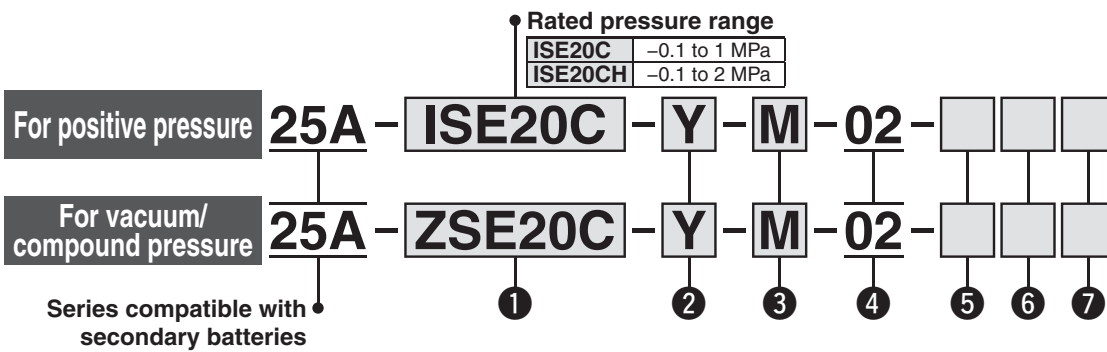

### 1 Rated pressure range

ZSE20C	0 to -101 kPa
ZSE20CF	-100 to 100 kPa

### 2 Output specification

Symbol	Description
R	NPN open collector 2 outputs + Analogue voltage output*1
S	NPN open collector 2 outputs + Analogue current output*1
T	PNP open collector 2 outputs + Analogue voltage output*1
V	PNP open collector 2 outputs + Analogue current output*1
X	NPN open collector 2 outputs + Copy function
Y	PNP open collector 2 outputs + Copy function

\*1 Can be switched to auto-shift or copy function

### 3 Unit specification

Symbol	Description
—	Units selection function
M	SI unit only*1
P	Units selection function (Initial value psi)

\*1 Fixed unit: kPa, MPa

### 4 Piping specification

Symbol	Description
02	R1/4 (M5 female threaded)

### 5 Option 1

Symbol	Description
—	Without lead wire
W	Lead wire with connector, 5-core (2 m lead wire, With waterproof cover)

### 7 Option 3

Symbol	Operation manual*1	Calibration certificate*1
—	○	—
Y	—	—
K	○	○
T	—	○

\*1 All texts are in both English and Japanese.

### 6 Option 2

Symbol	Description
—	None
B	Panel mount adapter
D	Panel mount adapter + Front protection cover

## Options/Part Nos.

When only optional parts are required, order with the part numbers listed below.

Description	Part no.	Note
Panel mount adapter	ZS-46-B	Rear ported
Panel mount adapter + Front protection cover	ZS-46-D	Rear ported
Lead wire with connector	ZS-46-5F	5-core, 2 m, Waterproof (With waterproof cover)
Front protection cover	ZS-27-01	Rear ported

# 2-Colour Display

# Digital Flow Switch

# 25A-PFMB7 Series



## How to Order

**25A - PFMB7 201 - C8 - B W - M**

Series compatible with secondary batteries

Rated flow range (Flow rate range)

201	2 to 200 l/min
-----	----------------

Port size

C8	Ø 8 (5/16") One-touch fitting
O2*1	Rc1/4
N02*1	NPT1/4
F02*1	G1/4 *2

\*1 Made to order

\*2 ISO1179-1 compliant

Piping entry direction

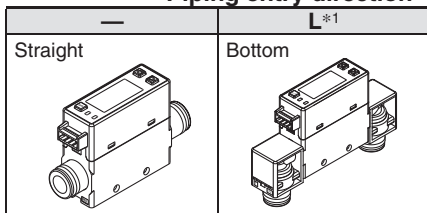

\*1 Made to order

Output specification

	OUT1	OUT2	Applicable monitor unit model
A	NPN	NPN	—
B	PNP	PNP	—
C	NPN	Analogue 1 to 5 V	PFG300 series
D	NPN	Analogue 4 to 20 mA	PFG310 series
E*1	PNP	Analogue 1 to 5 V	PFG300 series
F*1	PNP	Analogue 4 to 20 mA	PFG310 series
G*1	NPN	External input *2	—
H*1	PNP	External input *2	—

\*1 Made to order

\*2 Accumulated flow value, peak/bottom flow value can be reset by external signal input.

Option 1

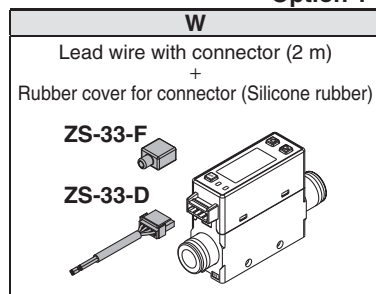

\* When only optional parts are required, refer to Option 1/Part Nos. on page 176.

Calibration certificate \*1

—	None
A*2	With calibration certificate

\*1 Certificate in both English and Japanese

\*2 Made to order

Option 2

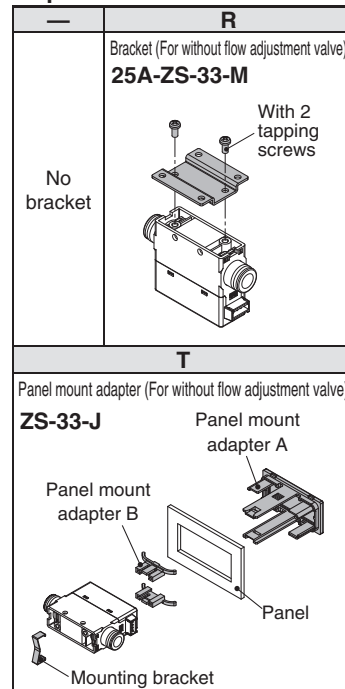

\* Options are shipped together with the product, but not assembled.

When only optional parts are required, refer to Option 2/Part Nos. on page 176.

Unit specification

M	SI unit only *1
—	Units selection function *2

\*1 Fixed unit: Instantaneous flow: l/min  
Accumulated flow: L

\*2 This product is for overseas use only according to the New Measurement Act. (The SI unit type is provided for use in Japan.)

Unit can be changed. Instantaneous flow: l/min ⇔ cfm  
Accumulated flow: L ⇔ ft<sup>3</sup>

\* The 25A- series specifications and dimensions are the same as those of the standard model.

## How to Order



**25A - PFMB7 501 - 04 - B W - M**

- Series compatible with secondary batteries

### Rated flow range (Flow rate range)

<b>501</b>	5 to 500 l/min
<b>102</b>	10 to 1000 l/min
<b>202</b>	20 to 2000 l/min

### Thread type

—	Rc
<b>N</b>	NPT
<b>F</b>	G *1

\*1 ISO228 compliant

### Port size

	Port size	Rated flow range		
		501	102	202
<b>04</b>	1/2	●	●	—
<b>06</b>	3/4	—	—	●

### Output specification

	OUT1	OUT2	Applicable monitor unit model
<b>A</b>	NPN	NPN	—
<b>B</b>	PNP	PNP	—
<b>C</b>	NPN	Analogue 1 to 5 V	PFG300 series
<b>D</b>	NPN	Analogue 4 to 20 mA	PFG310 series
<b>E</b> *1	PNP	Analogue 1 to 5 V	PFG300 series
<b>F</b> *1	PNP	Analogue 4 to 20 mA	PFG310 series
<b>G</b> *1	NPN	External input *2	—
<b>H</b> *1	PNP	External input *2	—

\*1 Made to order

\*2 Accumulated flow value, peak/bottom flow value can be reset by external signal input.

### Option 1

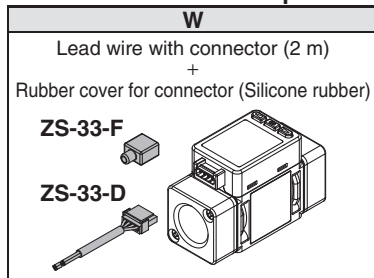

\* When only optional parts are required, refer to Option 1/Part Nos. below.

### Calibration certificate \*1

—	None
<b>A</b> *2	With calibration certificate

\*1 Certificate in both English and Japanese

\*2 Made to order

### Option 2

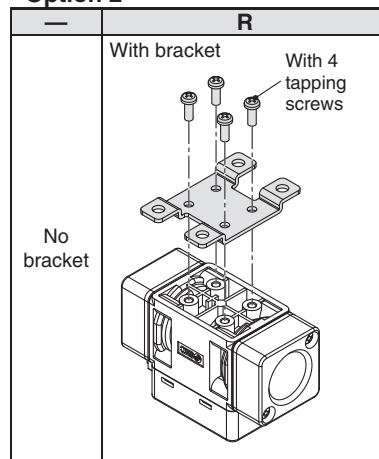

\* Options are shipped together with the product, but not assembled. When only optional parts are required, refer to Option 2/Part Nos. below.

### Unit specification

<b>M</b>	SI unit only *1
—	Units selection function *2

\*1 Fixed unit: Instantaneous flow: l/min  
Accumulated flow: L

\*2 This product is for overseas use only according to the New Measurement Act. (The SI unit type is provided for use in Japan.)

Unit can be changed. Instantaneous flow: l/min ↔ cfm  
Accumulated flow: L ↔ ft<sup>3</sup>

### Option 1/Part Nos.

Option	Part no.	Qty.	Note
Lead wire with connector	<b>ZS-33-D</b>	1	Lead wire: 2 m
Rubber cover (Silicone rubber)	<b>ZS-33-F</b>	1	For connector

### Option 2/Part Nos.

Option	Part no.	Qty.	Note
Bracket (for PFMB7201)	<b>25A-ZS-33-M</b>	1	With 2 tapping screws (3 x 6)
Panel mount adapter (for PFMB7201)	<b>ZS-33-J</b>	1	
Bracket (for PFMB7501/7102)	<b>25A-ZS-42-C</b>	1	With 4 tapping screws (3 x 6)
Bracket (for PFMB7202)	<b>25A-ZS-42-D</b>	1	With 4 tapping screws (3 x 6)

\* The 25A-series specifications and dimensions are the same as those of the standard model.

# 2-Colour Display

## Digital Flow Switch Remote sensor unit

# 25A-PFM5 Series



RoHS



### How to Order

Remote sensor unit **25A - PFM 5 10 - C6** **1** **-** **W**

Series compatible with secondary batteries

Type

5	Remote sensor unit
---	--------------------

Rated flow range (Flow rate range)

10	0.2 to 10 (5) l/min
25	0.5 to 25 (12.5) l/min
50	1 to 50 (25) l/min
11	2 to 100 (50) l/min

\* ( ): Fluid: CO<sub>2</sub>

Piping entry direction

—	Straight
L	Bottom

Output specification

No.	Description	Applicable display unit
1	Analogue output (1 to 5 V)	25A-PFM30□
2	Analogue output (4 to 20 mA)	25A-PFM31□

Calibration certificate

—	None
A	With calibration certificate

\* The certificate is written in English and Japanese. Other languages are available as specials.

Operation manual

—	With operation manual (Japanese and English)
N	None

Option 1

With lead wire with connector (2 m)  
+  
Rubber cover for connector (silicon rubber)

ZS-33-F

ZS-33-D

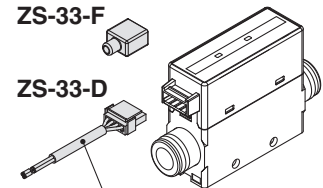

Lead wire length 2 m

Option 2

—	R	T
None	<p>Bracket (For without flow adjustment valve) <b>25A-ZS-33-M</b></p> <p>Mounting screw (accessory)</p>	<p>Panel mount adapter (For without flow adjustment valve) <b>ZS-33-J</b></p> <p>Panel mount adapter A</p> <p>Panel mount adapter B</p> <p>Panel</p> <p>Mounting bracket</p>

Options are shipped together with the product, but not assembled.

Port size

Symbol	Description	Flow rate range			
		10	25	50	11
01	Rc1/8	●	●	●	
02	Rc1/4				●
N01	NPT1/8	●	●	●	
N02	NPT1/4				●
F01	G1/8*1	●	●	●	
F02	G1/4*1				●
C6	∅ 6 One-touch fitting	●	●	●	●
C8	∅ 8 (5/16") One-touch fitting		●	●	●

\*1 ISO228-1 compliant

### Piping Variations

	With One-touch fittings (C6, C8)		Female thread (01, 02, N01, N02, F01, F02)	
	Straight (—)	Bottom (L)	Straight (—)	Bottom (L)
	Without flow adjustment valve (—)			

\* The 25A-series specifications and dimensions are the same as those of the standard model.

# Flow Sensor Monitor

## 25A-PFM3 Series



### How to Order

#### Output specification

0	2 NPN outputs + 1 to 5 V output
1	2 NPN outputs + 4 to 20 mA output
2	2 NPN outputs + External input*1
3	2 PNP outputs + 1 to 5 V output
4	2 PNP outputs + 4 to 20 mA output
5	2 PNP outputs + External input*1

\*1 User can select from accumulated value external reset, auto-shift and auto-shift zero.

#### Operation manual

—	With operation manual (Japanese and English)
N	None

#### Calibration certificate

—	None
A	With calibration certificate

\* The certificate is written in English and Japanese. Other languages are available as specials.

**25A-PFM3 0 3 - M L**

Series compatible with secondary batteries

#### Type

3	Remote display unit
---	---------------------

#### Input specification

Symbol	Content	Applicable remote type sensor unit
0	Voltage input	25A-PFM5□□-□-1-□
1	Current input	25A-PFM5□□-□-2-□

#### Unit specification

—	With unit switching function*1
M	Fixed SI unit*2

\*1 Under the New Measurement Act, flow sensor monitors with the unit switching function are not permitted for use in Japan.

\*2 Fixed unit: Instantaneous flow: l/min  
Accumulated flow: L

#### Option 1

—	None
L	Power supply/Output connector

\* The cable does not come connected, but it is shipped together with the product.

#### Option 3

—	None
F	With sensor connector

\* The connector does not come connected, but it is shipped together with the product.

#### Option 2

—	None
B	Panel mount adapter
D	Panel mount adapter + Front protective cover

\* Options are shipped together with the product, but not assembled.

### Options/Part Nos.

Description	Part no.	Note
Power supply/Output connector (2 m)	ZS-28-A	
Sensor connector	ZS-28-C-1	1 pc.
Panel mount adapter	ZS-46-B	
Panel mount adapter + Front protective cover	ZS-46-D	

\* The 25A-series specifications and dimensions are the same as those of the standard model.

# 3-Colour Display

# Digital Flow Monitor for Water

# 25A-PF3W Series



RoHS



## How to Order

**25A-PF3W 30 B**    **-M V C**   

Series compatible with secondary batteries

Type

**3** Remote monitor unit

For remote sensor units, select the analogue output 1 to 5 V type.  
Applicable sensors: PF3W5□□-□□-1(T)

### Output specification

Symbol	OUT1	OUT2
<b>A</b>	NPN	NPN
<b>B</b>	PNP	PNP
<b>C</b>	NPN	Analogue 1 to 5 V
<b>D</b>	NPN	Analogue 4 to 20 mA
<b>E</b>	PNP	Analogue 1 to 5 V
<b>F</b>	PNP	Analogue 4 to 20 mA
<b>G</b>	NPN	External input
<b>H</b>	PNP	External input
<b>J</b>	Analogue 1 to 5 V	Analogue 1 to 5 V
<b>K</b>	Analogue 4 to 20 mA	Analogue 4 to 20 mA

In combination with remote sensor unit with temperature sensor, only OUT2 can be set for temperature sensor output.

### Lead wire

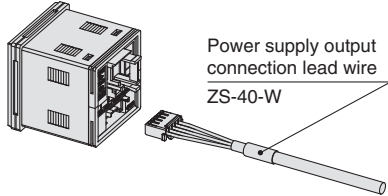
—	With power supply/output connection lead wire (2 m) 
<b>N</b>	Without power supply/output connection lead wire

The lead wire does not come connected, but it is shipped together with the product.

### Remote monitor unit/Unit specification

Symbol	Instantaneous flow	Accumulated flow	Temperature
<b>M</b>	l/min	L	°C
<b>G</b>	gal/min	gal	°C
<b>F</b>	gal/min	gal	°F
<b>J</b>	l/min	L	°F

\* G, F, J: Made to order

Reference: 1 [l/min] ↔ 0.2642 [gal/min]

1 [gal/min] ↔ 3.785 [l/min]

°F = 9/5 °C + 32

Calibration certificate (Only flow monitor)

—	None
<b>A</b>	With calibration certificate

\* The certificate is written in both Japanese and English.

### Option 2

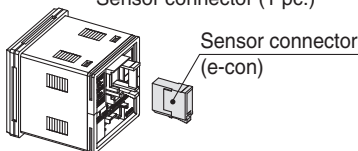
—	None
<b>C</b>	Sensor connector (1 pc.) 

The connector does not come connected, but it is shipped together with the product.

### Option 1

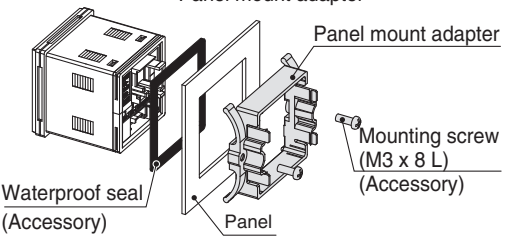
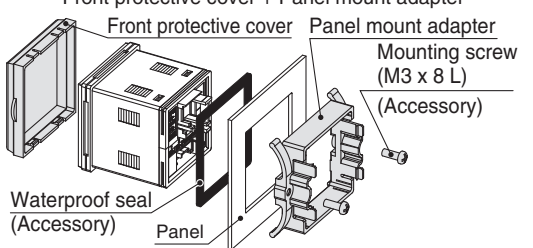
—	None
<b>T</b>	Panel mount adapter  Waterproof seal (Accessory) Panel Mounting screw (M3 x 8 L) (Accessory)
<b>V</b>	Front protective cover + Panel mount adapter  Front protective cover Panel mount adapter Waterproof seal (Accessory) Panel Mounting screw (M3 x 8 L) (Accessory)

## Options/Part Nos.

When only optional parts are required, order with the part numbers listed below.

Description	Part no.	Note
Panel mount adapter	<b>25A-ZS-26-B</b>	With waterproof seal and screws
Front protective cover + Panel mount adapter	<b>25A-ZS-26-C</b>	With waterproof seal and screws
Front protective cover only	<b>ZS-26-01</b>	Separately order panel mount adapter, etc.
Power supply/output connection lead wire	<b>ZS-40-W</b>	Lead wire length: 2 m
Sensor connector (e-con)	<b>ZS-28-CA-4</b>	1 pc.
Lead wire with connector for copying	<b>ZS-40-Y</b>	Connect up to 10 slave units

\* The 25A- series specifications and dimensions are the same as those of the standard model.



# 2-Colour Display Digital Flow Switch

Integrated  
display



# 25A-PFM7 Series



## How to Order

**Integrated display**

**25A - PFM7 10 - C6 - B - M - W**

**Series compatible with secondary batteries**

**Type**

7	Integrated display
---	--------------------

**Rated flow range (Flow rate range)**

10	0.2 to 10 (5) l/min
25	0.5 to 25 (12.5) l/min
50	1 to 50 (25) l/min
11	2 to 100 (50) l/min

\* ( ): Fluid: CO<sub>2</sub>

**Port size**

Symbol	Description	Flow rate range			
		10	25	50	11
01	Rc1/8	●	●	●	—
02	Rc1/4	—	—	—	●
N01	NPT1/8	●	●	●	—
N02	NPT1/4	—	—	—	●
F01	G1/8	●	●	●	—
F02	G1/4	—	—	—	●
C6	∅ 6 One-touch fitting	●	●	●	●
C8	∅ 8 (5/16") One-touch fitting	—	●	●	●

**Piping entry direction**

—	Straight
L	Bottom

**Output specifications**

A	2 NPN outputs
B	2 PNP outputs
C	1 NPN output + Analogue output (1 to 5 V)
D	1 NPN output + Analogue output (4 to 20 mA)
E	1 PNP output + Analogue output (1 to 5 V)
F	1 PNP output + Analogue output (4 to 20 mA)
G	1 NPN output + External input <sup>*3</sup>
H	1 PNP output + External input <sup>*3</sup>

<sup>\*3</sup> User can select from accumulated value external reset, auto-shift and auto-shift zero.

**Unit specifications**

—	With unit switching function
M	Fixed SI unit <sup>*1</sup>

<sup>\*1</sup> Fixed unit: Instantaneous flow: l/min  
Accumulated flow: L

**Option 1**

W	Lead wire with connector (2 m) + Rubber cover for connector (Silicon rubber)
---	--

**Calibration certificate**

—	None
A	With calibration certificate

\* The certificate is written in English and Japanese.  
Other languages are available as specials.

**Operation manual**

—	With operation manual (Japanese and English)
N	None

**Option 2**

—	None
R	Bracket (For without flow adjustment valve) <b>25A-ZS-33-M</b> 
T	Panel mount adapter (For without flow adjustment valve) <b>ZS-33-J</b> 

\* The 25A- series specifications and dimensions are the same as those of the standard model.

\* Digital flow switch with flow adjustment valve is not standard product. It can be supplied as Made-to-Order separately.



# 3-colour display

## Digital Flow Switch for Water

# 25A-PF3W Series



### How to Order

#### Remote sensor unit

#### Output specification/Temperature sensor

Symbol	OUT1	OUT2	Temperature sensor
	Flow rate	Temperature	
1	Analogue 1 to 5 V	—	None
2	Analogue 4 to 20 mA	—	
1T	Analogue 1 to 5 V	Analogue 1 to 5 V	

\* To use in combination with remote monitor (PF3W3 series), select analogue output of 1 to 5 V of flow rate (output symbol "-1" or "-1T").

#### Remote sensor unit/Unit printed on label

Symbol	Instantaneous flow rate	Temperature
—	l/min	°C
G*1	l/min (gal/min)	°C/°F

\* G: Made to Order  
Reference: 1 [l/min] ↔ 0.2642 [gal/min]  
1 [gal/min] ↔ 3.785 [l/min]  
°F = 9/5 °C + 32



#### Remote sensor unit

#### Integrated display

Series compatible with secondary batteries

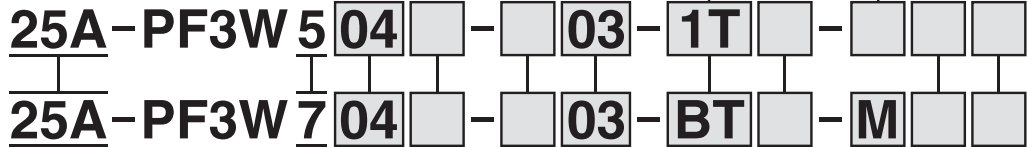

Type

5	Remote sensor unit
7	Integrated display

#### Rated flow range (Flow range)

Symbol	Rated flow range
04	0.5 to 4 l/min
20	2 to 16 l/min
40	5 to 40 l/min
11	10 to 100 l/min

#### Thread type

—	Rc
N	NPT
F	G

#### Port size

Symbol	Port size	Rated flow range			
		04	20	40	11
03	3/8	●	●	—	—
04	1/2	—	●	●	—
06	3/4	—	—	●	●
10	1/1	—	—	—	●

#### Flow adjustment valve

Symbol	With/without flow adjustment valve	Rated flow rate			
		04	20	40	11
—	None	●	●	●	—
S	Yes	●	●	●	—

100 l/min type is not available with flow adjustment valve.

#### Integrated display

#### Output specification/ Temperature sensor

Symbol	OUT1	OUT2		Temperature sensor
	Flow rate	Flow rate	Temperature	
A	NPN	NPN	—	None
B	PNP	PNP	—	
C	NPN	Analogue 1 to 5 V	—	
D	NPN	Analogue 4 to 20 mA	—	
E	PNP	Analogue 1 to 5 V	—	
F	PNP	Analogue 4 to 20 mA	—	
G	NPN	External input*1	—	
H	PNP	External input*1	—	
AT	NPN	(NPN)	*2 NPN	With temperature sensor
BT	PNP	(PNP)	*2 PNP	
CT	NPN	(Analogue 1 to 5 V)	*2 Analogue 1 to 5 V	
DT	NPN	(Analogue 4 to 20 mA)	*2 Analogue 4 to 20 mA	
ET	PNP	(Analogue 1 to 5 V)	*2 Analogue 1 to 5 V	
FT	PNP	(Analogue 4 to 20 mA)	*2 Analogue 4 to 20 mA	

#### Calibration certificate (Only flow sensor)

—	None
A	With calibration certificate

\* The certificate is written in both English and Japanese. Integrated display type with temperature sensor can only display flow rate.

#### Bracket (Option)

—	None
R	Bracket

#### Integrated display/Unit specification

Symbol	Instantaneous flow rate	Accumulated flow	Temperature
M	l/min	L	°C
G	gal/min	gal	°C
F	gal/min	gal	°F
J	l/min	L	°F

\* G, F, J: Made to Order  
Reference: 1 [l/min] ↔ 0.2642 [gal/min]  
1 [gal/min] ↔ 3.785 [l/min]  
°F = 9/5 °C + 32

#### Lead wire (Option)

—	N
With lead wire with M8 connector (3 m)	Without lead wire with M8 connector

\* The 25A-series specifications and dimensions are the same as those of the standard model.

\* The 25A-series specifications and dimensions are the same as those of the standard model.

\*1 External input: The accumulated value, peak value, and bottom value can be reset.

\*2 For units with temperature sensor, OUT2 can be set as either temperature output or flow rate output. Setting when shipped is for temperature output.

### Options/Part Nos.

When optional parts are required separately, use the following part numbers to place an order.

Description	Part no	Qty.	Note
Bracket*1	25A-ZS-40-K	1	For PF3W704/720/504/520 With 4 tapping screws (3 x 8)
	25A-ZS-40-L	1	For PF3W740/540 With 4 tapping screws (3 x 8)
	25A-ZS-40-M	1	For PF3W711/511 With 4 tapping screws (4 x 10)
Lead wire with M8 connector	25A-ZS-40-A	1	Lead wire length (3 m)

\*1 For units with flow adjustment valve, 2 brackets are required.

# 3-colour display

## Digital Flow Switch for PVC Piping

# 25A-PF3W Series €

RoHS

### How to Order

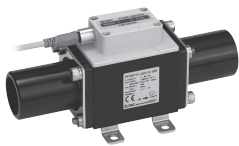

#### Remote sensor unit Output specification

Symbol	OUT1
1	Analogue 1 to 5 V
2	Analogue 4 to 20 mA

\* To use in combination with remote monitor (PF3W3 series), select analogue output of 1 to 5 V of flow rate (output symbol "1").

#### Remote sensor unit/Unit printed on label

Symbol	Instantaneous flow rate
—	l/min
G*1	l/min (gal/min)

\* G: Made to Order

Reference: 1 [l/min] ↔ 0.2642 [gal/min]  
1 [gal/min] ↔ 3.785 [l/min]

#### Calibration certificate (Only flow sensor)

—	None
A	With calibration certificate

\* The certificate is written in both English and Japanese.

#### Remote sensor unit

#### Integrated display

Series compatible with secondary batteries



25A - PF3W 5 11 - U 25 - 1 [ ] [ ] [ ] [ ]  
25A - PF3W 7 11 - U 25 - B [ ] [ ] [ ] [ ]

#### Type

5	Remote sensor unit
7	Integrated display

#### Rated flow range (Flow range)

Symbol	Rated flow range
11	10 to 100 l/min

#### Connection type

U	PVC pipe
---	----------

#### PVC pipe O.D.

Symbol	Port size	Pipe O.D.*1
25	25A	32 mm

\*1 JIS K6742 equivalent

#### Integrated display Output specification

Symbol	OUT1	OUT2
A	NPN	NPN
B	PNP	PNP
C	NPN	Analogue 1 to 5 V
D	NPN	Analogue 4 to 20 mA
E	PNP	Analogue 1 to 5 V
F	PNP	Analogue 4 to 20 mA
G	NPN	External input*1
H	PNP	External input*1

\*1 External input: The accumulated value, peak value, and bottom value can be reset.

#### Bracket (Option)

—	None
R	Bracket

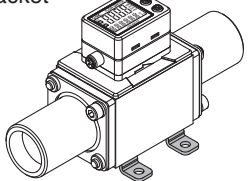

#### Integrated display/Unit specification

Symbol	Instantaneous flow rate	Accumulated flow
M	l/min	L
G	gal/min	gal

\* G: Made to Order

Reference: 1 [l/min] ↔ 0.2642 [gal/min]  
1 [gal/min] ↔ 3.785 [l/min]

#### Lead wire

—	N
With lead wire with M8 connector (3 m)	Without lead wire with M8 connector

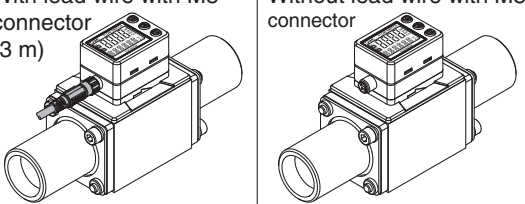

\* The 25A- series specifications and dimensions are the same as those of the standard model.

### Options/Part Nos.

When optional parts are required separately, use the following part numbers to place an order. \* The 25A- series specifications and dimensions are the same as those of the standard model.

Description	Part no.	Qty.	Note
Bracket	25A-ZS-40-M	1	For PF3W711/511 With 4 tapping screws (4 x 10)
Lead wire with M8 connector	25A-ZS-40-A	1	Lead wire length (3 m)

# Direct Operated 2-Port Solenoid Valve

 For Air Single Unit

# 25A-VX21/22/23 Series

## How to Order (Single Unit)



### Common Specifications

Valve type	N.C.
Seal material	NBR
Coil insulation type	Class B
Thread type	Rc

25A - VX2 1 0 A A

Series compatible with secondary batteries

Fluid

0 For air

### Size/Valve type

### Body material/Port size/Orifice diameter

Symbol	Size	Valve type	Symbol	Body material	Port size	Orifice diameter	
1	Size 1	Single unit N.C.	A	Aluminium	1/8	2	
			B			3	
			C			5	
			D			1/4	2
			E				3
			F	5			
			H	Resin	Ø 6 One-touch fitting	2	
			J			3	
			K			5	
			L			2	
M	3						
N	5						
2	Size 2	Single unit N.C.	A	Aluminium	1/4	4	
			B			7	
			D			4	
			E	3/8	7		
			H		4		
			J	Resin	Ø 8 One-touch fitting	7	
			L			4	
M	Ø 10 One-touch fitting	7					
3	Size 3	Single unit N.C.	A	Aluminium	1/4	5	
			B			8	
			C			10	
			D		3/8	5	
			E			8	
			F			10	
			G	1/2	10		
			H		5		
			J	Resin	Ø 10 One-touch fitting	8	
			K			10	
			L			5	
			M	Ø 12 One-touch fitting	8		
			N		10		

### Voltage/Electrical entry

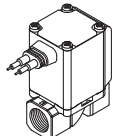
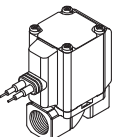
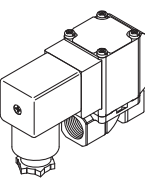
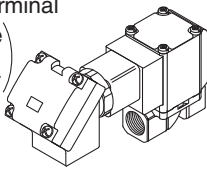
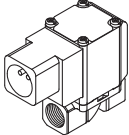
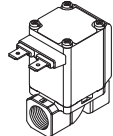
Symbol	Voltage	Electrical entry
A	24 VDC	Grommet 
B	100 VAC	Grommet (With surge voltage suppressor) 
C	110 VAC	
D	200 VAC	
E	230 VAC	DIN terminal (With surge voltage suppressor) 
F	24 VDC	
G	24 VDC	
H	100 VAC	
J	110 VAC	Conduit terminal (With surge voltage suppressor) 
K	200 VAC	
L	230 VAC	
M	24 VDC	Conduit (With surge voltage suppressor) 
N	100 VAC	
P	110 VAC	
Q	200 VAC	
R	230 VAC	Flat terminal 
S	24 VDC	
T	100 VAC	
U	110 VAC	
V	200 VAC	
W	230 VAC	Other voltages and electrical options
Y	24 VDC	
Z		

For other special options, refer to the standard products.

Special voltage	48 VAC
	220 VAC
	240 VAC
	12 VDC
DIN terminal with light	
Conduit terminal with light	
Low concentration ozone resistant (Seal material: FKM)	
Oil-free	
G thread	
NPT thread	

\* The 25A- series specifications and dimensions are the same as those of the standard model.

# Direct Operated 2-Port Solenoid Valve

## 25A-VX21/22/23 Series

 For Water Single Unit

 For Oil Single Unit

 For Medium Vacuum Single Unit



CE RoHS

### How to Order (Single Unit)

25A - VX2 1 4 A A

Series compatible with secondary batteries

Fluid

2	For water
3	For oil
4	For medium vacuum

#### Size/Valve type

Symbol	Size	Valve type
1	Size 1	Single unit N.C.

#### Body material/Port size/Orifice diameter

Symbol	Body material	Port size	Orifice diameter
H	Stainless steel	1/8	2
J			3
K			5
L		1/4	2
M			3
N			5

Symbol	Size	Valve type
2	Size 2	Single unit N.C.

Symbol	Body material	Port size	Orifice diameter
H	Stainless steel	1/4	4
J			7
L		3/8	4
M			7

Symbol	Size	Valve type
3	Size 3	Single unit N.C.

Symbol	Body material	Port size	Orifice diameter
H	Stainless steel	1/4	5
J			8
K			10
L		3/8	5
M			8
N			10
P		1/2	10

#### Common Specifications

Valve type	N.C.
Seal material	NBR (For water)
	FKM (For oil, medium vacuum)
Coil insulation type	Class B
Thread type	Rc

#### Voltage/Electrical entry

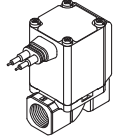
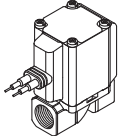
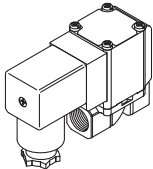
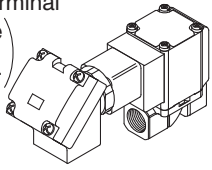
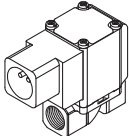
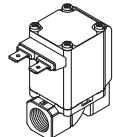
Symbol	Voltage	Electrical entry
A	24 VDC	Grommet 
B	100 VAC	Grommet (With surge voltage suppressor) 
C	110 VAC	
D	200 VAC	
E	230 VAC	
F	24 VDC	DIN terminal (With surge voltage suppressor) 
G	24 VDC	
H	100 VAC	
J	110 VAC	
K	200 VAC	
L	230 VAC	Conduit terminal (With surge voltage suppressor) 
M	24 VDC	
N	100 VAC	
P	110 VAC	
Q	200 VAC	Conduit (With surge voltage suppressor) 
R	230 VAC	
S	24 VDC	
T	100 VAC	
U	110 VAC	
V	200 VAC	Flat terminal 
W	230 VAC	
Y	24 VDC	
Z	Other voltages and electrical options	

For other special options, refer to the standard products.

Special voltage	48 VAC
	220 VAC
	240 VAC
	12 VDC
DIN terminal with light	
Conduit terminal with light	
G thread	
NPT thread	

\* The 25A- series specifications and dimensions are the same as those of the standard model.

# Pilot Operated 2-Port Solenoid Valve For Air

## 25A-VXD Series



### How to Order

**25A - VXD2 3 0 A A**

Series compatible with secondary batteries

Fluid

0 For Air

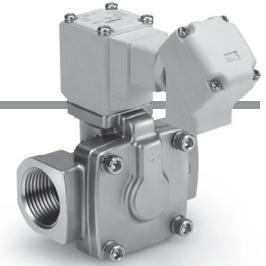

#### Common Specifications

Seal material	NBR
Coil insulation type	Class B
Thread type	Rc

#### Size—Valve type

Symbol	Size	Valve type
3	8A	N.C.
	10A	N.O.
	15A	
4	10A	N.C.
	15A	N.O.
5	20A	N.C.
		N.O.
6	25A	N.C.
		N.O.

#### Body material/Port size/Orifice diameter

Symbol	Body material	Port size	Orifice diameter
A	Aluminium	1/4	10
		3/8	
		1/2	
J	Stainless steel	3/8	15
		1/2	
M	Stainless steel	3/4	20
		1	
P	Stainless steel	1	25

#### Voltage/Electrical entry

Symbol	Voltage	Electrical entry	
A	24 VDC	Grommet	
	B	100 VAC	Grommet (With surge voltage suppressor)
	C	110 VAC	
D	200 VAC		
E	230 VAC	DIN terminal (With surge voltage suppressor)	
F	24 VDC		
G	24 VDC		
H	100 VAC	Conduit terminal (With surge voltage suppressor)	
J	110 VAC		
K	200 VAC		
L	230 VAC	Conduit (With surge voltage suppressor)	
M	24 VDC		
N	100 VAC		
P	110 VAC	Flat terminal	
Q	200 VAC		
R	230 VAC		
S	24 VDC	Other special options	
T	100 VAC		
U	110 VAC		
V	200 VAC		
W	230 VAC		
Y	24 VDC		
Z			

All other special options are the same as those of the standard model.

Special voltage	24 VAC
	48 VAC
	220 VAC
	240 VAC
DIN terminal with light	12 VDC
Conduit terminal with light	
Without DIN connector	
Low concentration ozone resistant (Seal material: FKM)	
Seal material: EPDM	
Oil-free	
G thread	
NPT thread	
With bracket	
Special electrical entry direction	

\* The 25A- series specifications and dimensions are the same as those of the standard model.

# Pilot Operated 2-Port Solenoid Valve For Water

## 25A-VXD Series



### How to Order

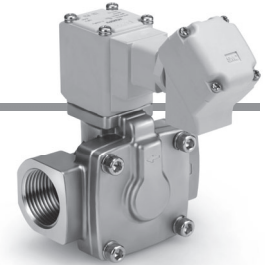

#### Common Specifications

Seal material	NBR
Coil insulation type	Class B
Thread type	Rc

**25A - VXD2 3 2 D A**

Series compatible with secondary batteries

Fluid

2 For Water

#### Size—Valve type

Symbol	Size	Valve type
3	8A	N.C.
	10A	N.O.
A	15A	

Symbol	Size	Valve type
4	10A	N.C.
	15A	N.O.

Symbol	Size	Valve type
5	20A	N.C.
	C	20A

Symbol	Size	Valve type
6	25A	N.C.
		D

#### Body material/Port size/Orifice diameter

Symbol	Body material	Port size	Orifice diameter
D	Stainless steel	1/4	10
		3/8	
		1/2	

Symbol	Body material	Port size	Orifice diameter
J	Stainless steel	3/8	15
		K	

Symbol	Body material	Port size	Orifice diameter
M	Stainless steel	3/4	20

Symbol	Body material	Port size	Orifice diameter
P	Stainless steel	1	25

#### Voltage/Electrical entry

Symbol	Voltage	Electrical entry		
A	24 VDC	Grommet		
	B	100 VAC	Grommet (With surge voltage suppressor)	
		C		110 VAC
		D		200 VAC
	E	230 VAC		
	F	24 VDC		
G	24 VDC	DIN terminal (With surge voltage suppressor)		
	H		100 VAC	
	J		110 VAC	
	K		200 VAC	
	L		230 VAC	
	M		24 VDC	Conduit terminal (With surge voltage suppressor)
N	100 VAC			
P	110 VAC			
Q	200 VAC			
R	230 VAC			
S	24 VDC	Conduit (With surge voltage suppressor)		
	T		100 VAC	
	U		110 VAC	
	V		200 VAC	
W	230 VAC			
Y	24 VDC	Flat terminal		
			Z	Other voltages and electrical option

All other special options are the same as those of the standard model.

Special voltage	24 VAC
	48 VAC
	220 VAC
	240 VAC
Special voltage	12 VDC
	12 VDC
DIN terminal with light	
Conduit terminal with light	
Without DIN connector	
Applicable to deionised water (Seal material: FKM)	
Seal material: EPDM	
Oil-free	
G thread	
NPT thread	
With bracket	
Special electrical entry direction	

\* The 25A- series specifications and dimensions are the same as those of the standard model.



# Zero Differential Pressure Type Pilot Operated 2-Port Solenoid Valve/For Air

# 25A-VXZ Series

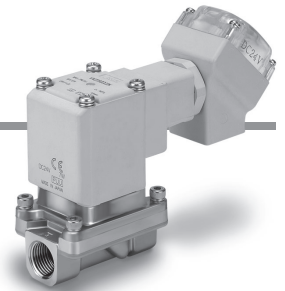

## How to Order (Single Unit)

**25A - VXZ2 3 0 A A**

Series compatible with secondary batteries

Fluid

0 For Air

### Size/Valve type

Symbol	Body size	Valve type	Symbol	Body material	Port size	Orifice diameter
<b>3</b>	10A	N.C.	<b>A</b>	Aluminium	1/4	10
<b>A</b>		N.O.	<b>B</b>		3/8	
<b>4</b>	15A	N.C.	<b>G</b>	Stainless steel	1/2	15
<b>B</b>		N.O.				
<b>5</b>	20A	N.C.	<b>J</b>	Stainless steel	3/4	20
<b>C</b>		N.O.				
<b>6</b>	25A	N.C.	<b>L</b>	Stainless steel	1	25
<b>D</b>		N.O.				

### Body material/Port size/Orifice diameter

### Voltage/Electrical entry

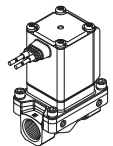
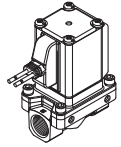
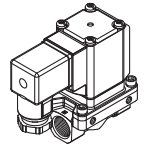
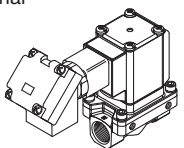
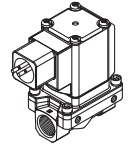
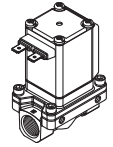
Symbol	Voltage	Electrical entry
<b>A</b>	24 VDC	Grommet 
	<b>B</b> 100 VAC	Grommet (With surge voltage suppressor) 
	<b>C</b> 110 VAC	
	<b>D</b> 200 VAC	
	<b>E</b> 230 VAC	
	<b>F</b> 24 VDC	DIN terminal (With surge voltage suppressor) 
<b>G</b> 24 VDC		
<b>H</b> 100 VAC		
<b>J</b> 110 VAC		
<b>K</b> 200 VAC		
<b>L</b> 230 VAC		
<b>M</b> 24 VDC	Conduit terminal (With surge voltage suppressor) 	
<b>N</b> 100 VAC		
<b>P</b> 110 VAC		
<b>Q</b> 200 VAC		
<b>R</b> 230 VAC	Conduit (With surge voltage suppressor) 	
<b>S</b> 24 VDC		
<b>T</b> 100 VAC		
<b>U</b> 110 VAC		
<b>V</b> 200 VAC	Flat terminal 	
<b>W</b> 230 VAC		
<b>Y</b>	24 VDC	
<b>Z</b>	Other voltages	

All other special options are the same as those of the standard model.

Special voltage	24 VAC
	48 VAC
	220 VAC
	240 VAC
Special electrical entry direction	12 VDC
DIN terminal with light	
Conduit terminal with light	
Without DIN connector	
Low concentration ozone resistant (Seal material: FKM)	
Seal material: EPDM	
Oil-free	
G thread	
NPT thread	
With bracket (Standard for resin body)	

\* The 25A- series specifications and dimensions are the same as those of the standard model.



# Zero Differential Pressure Type Pilot Operated 2-Port Solenoid Valve/For Water

## 25A-VXZ Series



### How to Order (Single Unit)

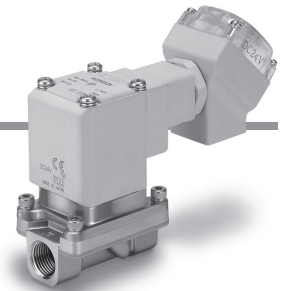

**25A - VXZ2 3 2 C A**

Series compatible with secondary batteries

Fluid

2 For Water

#### Common Specifications

Seal material	NBR
Coil insulation type	Class B
Thread type	Rc

#### Size/Valve type

Symbol	Body size	Valve type
3 A	10A	N.C.
		N.O.
4 B	15A	N.C.
		N.O.
5 C	20A	N.C.
		N.O.
6 D	25A	N.C.
		N.O.

#### Body material/Port size/Orifice diameter

Symbol	Body material	Port size	Orifice diameter
C D	Stainless steel	1/4	10
		3/8	
G	Stainless steel	1/2	15
J	Stainless steel	3/4	20
L	Stainless steel	1	25

#### Voltage/Electrical entry

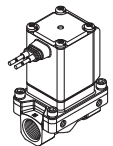
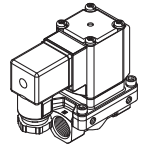
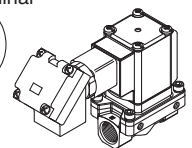
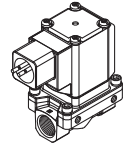
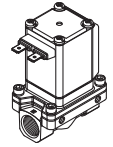
Symbol	Voltage	Electrical entry
A B C D E F	24 VDC	Grommet 
	100 VAC	
	110 VAC	
	200 VAC	
	230 VAC	
	24 VDC	
G H J K L	24 VDC	DIN terminal (With surge voltage suppressor) 
	100 VAC	
	110 VAC	
	200 VAC	
	230 VAC	
	24 VDC	
M N P Q R	24 VDC	Conduit terminal (With surge voltage suppressor) 
	100 VAC	
	110 VAC	
	200 VAC	
	230 VAC	
	24 VDC	
S T U V W	24 VDC	Conduit (With surge voltage suppressor) 
	100 VAC	
	110 VAC	
	200 VAC	
	230 VAC	
	24 VDC	
Y Z	24 VDC	Flat terminal 
	Other voltages	

All other special options are the same as those of the standard model.

Special voltage	24 VAC
	48 VAC
	220 VAC
	240 VAC
Special electrical entry direction	12 VDC
DIN terminal with light	
Conduit terminal with light	
Without DIN connector	
Applicable to deionised water (Seal material: FKM)	
Seal material: EPDM	
Oil-free	
G thread	
NPT thread	
With bracket	

\* The 25A- series specifications and dimensions are the same as those of the standard model.

# Diaphragm Valve for Ultra High Purity Air Operated Type

RoHS

# AZ3542 & 4542 □ 25A Series

- Suitable for UHP gas supply line
- Body material: 316L SS
- Pneumatically actuated normally closed



## How to Order

AZ **3** **542** **S** **2P** **MV4** **MV4** **25A**

(Inlet) (Outlet)

### Size

Code	Cv
3	0.29
4	0.5

### Model

Code	Status	Maximum operating pressure
542	Normally closed (N.C.)	125 psig (0.9 MPa)

### Material

Code	Body material
S	316L SS

### Ports

Code	Ports	Connection
2P	2 ports	Machined
2PW		Welded

- Series compatible with secondary batteries

### Connections

Code	Connections	Size Port	AZ3		AZ4	
			2P	2PW	2P	2PW
MV4	1/4 inch face seal (Male) *1)		●	●	●	●
FV4	1/4 inch face seal (Female)			●		●
TW4	1/4 inch tube weld		●			
MV6	3/8 inch face seal (Male) *1)				●	●
FV6	3/8 inch face seal (Female)					●
TW6	3/8 inch tube weld				●	●
TW8	1/2 inch tube weld				●	

●: Only available with the same type fittings inlet and outlet.

\* 1) Fixed fitting (no rotating nut)

## Specifications

Operating Parameters	AZ3542 □ 25A	AZ4542 □ 25A
Weight	0.26 kg *1)	

\*1) Weight for AZ3542S2PMV4MV4 including individual boxed weight. It may vary depending on connections or options.

\* Some parts have sizes and shapes that are different from the standard products.

# AZ3542 & 4542 □ 25A Series

## Dimensions

### AZ3542 & 4542

Ports: 2P (Machined)

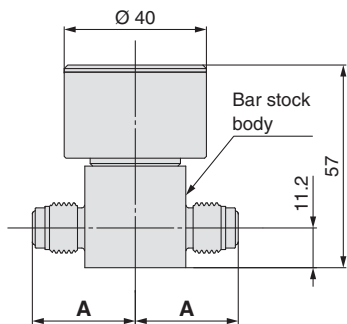
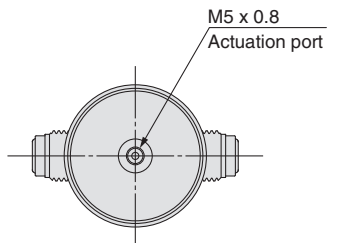

Connections: MV □

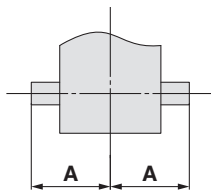

Connections: TW □

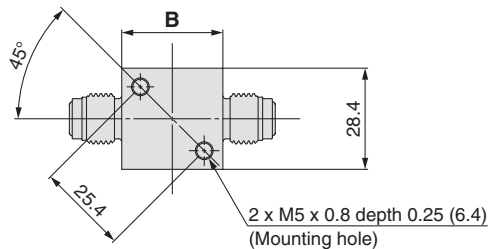

Ports: 2PW (Welded)

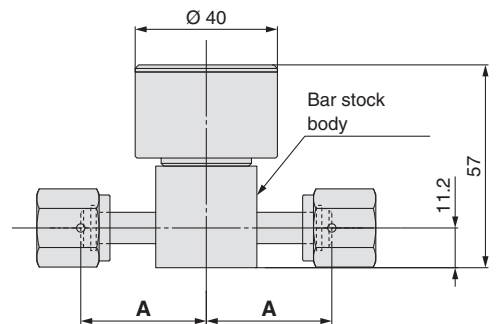
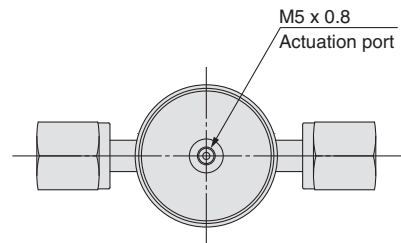

Connections: FV □

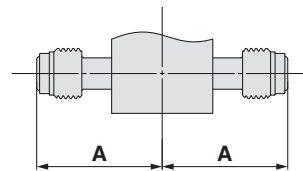

Connections: MV □

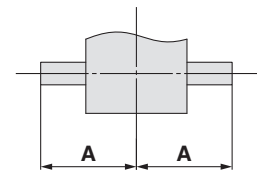

Connections: TW □

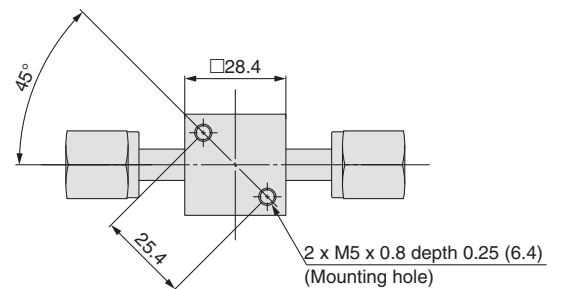

Ports	Connections	A	B
2P (Machined)	MV4	1.14 (29.0)	1.12 sq. (28.4)
	TW4	0.875 (22.2)	
	MV6	1.5 (38.1)	1.48 sq. (37.6)
	TW6	0.875 (22.2)	1.12 sq. (28.4)
	TW8	1.125 (28.6)	

Ports	Connections	A
2PW (Welded)	MV4	1.39 (35.3)
	FV4	
	TW4	1.06 (26.9)
	MV6	1.93 (49.0)
	FV6	
	TW6	

# Diaphragm Valves for General Applications

## Air Operated Type

RoHS

# AK3542 & 4542 25A Series

- Body material: 316 SS
- Normally closed



### How to Order

AK **3** 542 S 2P <sup>(Inlet)</sup> **4T** <sup>(Outlet)</sup> **4T** 25A

- Series compatible with secondary batteries

#### Size

Code	Cv
3	0.29
4	0.5

#### Model

Code	Status	Maximum operating pressure
542	Normally closed (N.C.)	125 psig (0.9 MPa)

#### Material

Code	Body material
S	316 SS

#### Ports

Code	Ports
2P	2 ports

#### Connections

Code	Connections	AK3	AK4
4T	1/4 inch compression	●	—
4BR	Rc 1/4		
4BRN	R 1/4		
4	NPT 1/4 female		
4N	NPT 1/4 male	—	●
6T	3/8 inch compression		
6BR	Rc 3/8		
6BRN	R 3/8		
6	NPT 3/8 female		
6N	NPT 3/8 male		

Note) Only available with same type fittings inlet and outlet.

\* Specifications and dimensions are the same as those of the standard model.

# Electric Actuator/Slider Type Ball Screw Drive

Secondary Battery Compatible

Applicable to the LEC□ series



## 25A-LEFS Series LEFS16, 25, 32, 40

Refer to the Catalogue at [www.smc.eu](http://www.smc.eu) for model selection.

Refer to page 191 for the communication protocols EtherCAT®, EtherNet/IP™, PROFINET, and DeviceNet™.

### How to Order

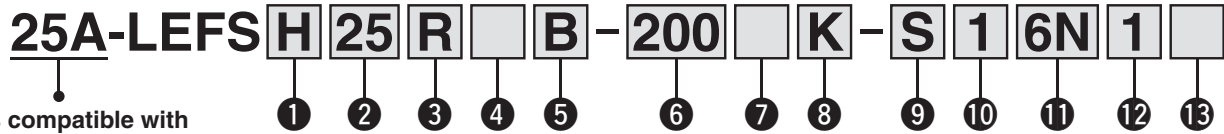

Series compatible with secondary batteries

#### 1 Accuracy

—	Basic type
<b>H</b>	High-precision type

#### 2 Size

<b>16</b>
<b>25</b>
<b>32</b>
<b>40</b>

#### 3 Motor mounting position

—	In-line
<b>R</b>	Right side parallel
<b>L</b>	Left side parallel

#### 4 Motor type

Symbol	Type	Applicable size				Compatible controller/driver
		LEFS16	LEFS25	LEFS32	LEFS40	
—	Step motor (Servo/24 VDC)	●	●	●	●	LECP6 LECP1 LECPA
<b>A</b>	Servo motor (24 VDC)	●	●	—	—	LECA6

#### 5 Lead [mm]

Symbol	LEFS16	LEFS25	LEFS32	LEFS40
<b>A</b>	10	12	16	20
<b>B</b>	5	6	8	10

#### 6 Stroke [mm]

<b>50</b>	50
<b>to</b>	to
<b>1000</b>	1000

\* Refer to the applicable stroke table.

#### 7 Motor option

—	Without option
<b>B</b>	With lock

### ⚠ Caution

#### [CE-compliant products]

① EMC compliance was tested by combining the electric actuator LEF series and the controller LEC series.

The EMC depends on the configuration of the customer's control panel and the relationship with other electrical equipment and wiring. Therefore, conformity to the EMC directive cannot be certified for SMC components incorporated into the customer's equipment under actual operating conditions. As a result, it is necessary for the customer to verify conformity to the EMC directive for the machinery and equipment as a whole.

② For the servo motor (24 VDC) specification, EMC compliance was tested by installing a noise filter set (LEC-NFA).

Refer to the **Catalogue at [www.smc.eu](http://www.smc.eu)** for the noise filter set. Refer to the LECA Operation Manual for installation.

#### [UL-compliant products]

When conformity to UL is required, the electric actuator and controller/driver should be used with a UL1310 Class 2 power supply.

### Applicable Stroke Table

Model \ Stroke [mm]	50	100	150	200	250	300	350	400	450	500	550	600	650	700	750	800	850	900	950	1000	Manufacturable stroke range [mm]	
<b>LEFS16</b>	●	●	●	●	●	●	●	●	●	●	—	—	—	—	—	—	—	—	—	—	—	50 to 500
<b>LEFS25</b>	●	●	●	●	●	●	●	●	●	●	●	●	—	—	—	—	—	—	—	—	—	50 to 600
<b>LEFS32</b>	●	●	●	●	●	●	●	●	●	●	●	●	●	●	●	●	—	—	—	—	—	50 to 800
<b>LEFS40</b>	—	—	●	●	●	●	●	●	●	●	●	●	●	●	●	●	●	●	●	●	●	150 to 1000

\* Please consult with SMC for non-standard strokes as they are produced as special orders.

### The actuator and controller/driver are sold as a package.

Confirm that the combination of the controller/driver and the actuator is correct.

<Check the following before use.>

- Check the actuator label for model number (after "25A-"). This matches the controller/driver.
- Check Parallel I/O configuration matches (NPN or PNP).

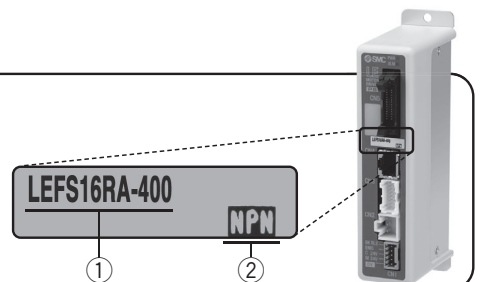

\* Refer to the operation manual for using the products. Please download it via our website, <https://www.smc.eu>

Motor mounting position:  
In-line

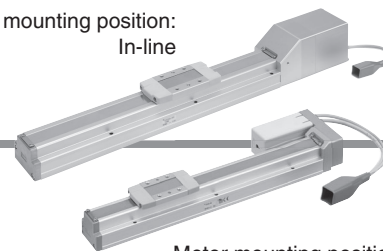

Motor mounting position:  
Right side parallel

### 8 Positioning pin hole

—	Housing B bottom*1	
K	Body bottom 2 locations	

\*1 Refer to the body mounting example in the **Catalogue at [www.smc.eu](http://www.smc.eu)** for the mounting method.

### 11 Controller/Driver type\*1

Without controller/driver		
6N	<b>LECP6/LECA6</b> (Step data input type)	NPN
6P		PNP
1N	<b>LECP1</b> *2 (Programless type)	NPN
1P		PNP
AN	<b>LECPA</b> *2 *4 (Pulse input type)	NPN
AP		PNP

- \*1 For details on controllers/drivers and compatible motors, refer to the compatible controller/driver below.
- \*2 Only available for the motor type "Step motor".
- \*3 When pulse signals are open collector, order the current limiting resistor (LEC-PA-R-□) separately.

### 9 Actuator cable type\*1

Without cable	
S	Standard cable*2
R	Robotic cable (Flexible cable)*3

- \*1 The standard cable should be used on fixed parts. For using on moving parts, select the robotic cable.
- \*2 Only available for the motor type "Step motor".
- \*3 Fix the motor cable protruding from the actuator to keep it unmovable. For details about fixing method, refer to Wiring/Cables in the Electric Actuators Precautions.

### 12 I/O cable length [m]\*1, Communication plug

Without cable (Without communication plug connector)*3	
1	1.5
3	3*2
5	5*2
S	Straight type communication plug connector*3
T	T-branch type communication plug connector*3

- \*1 When "Without controller/driver" is selected for controller/driver types, I/O cable cannot be selected. Refer to the **Catalogue at [www.smc.eu](http://www.smc.eu)** if I/O cable is required.
- \*2 When "Pulse input type" is selected for controller/driver types, pulse input usable only with differential. Only 1.5 m cables usable with open collector.
- \*3 When "CC-Link direct input type" is selected for controller/driver types, I/O cable is not included. Only "—", "S" or "T" can be selected.

### 10 Actuator cable length [m]

Without cable	
1	1.5
3	3
5	5
8	8*1
A	10*1
B	15*1
C	20*1

\*1 Produced upon receipt of order (Robotic cable only)

### 13 Controller/Driver mounting

Screw mounting	
D	DIN rail mounting*1

\*1 DIN rail is not included. Order it separately.

\* The 25A- series specifications and dimensions are the same as those of the standard model.

### Compatible Controller/Driver

Type	Step data input type	Step data input type	Programless type	Pulse input type
Series	<b>LECP6</b>	<b>LECA6</b>	<b>LECP1</b>	<b>LECPA</b>
Features	Value (Step data) input Standard controller		Capable of setting up operation (step data) without using a PC or teaching box	Operation by pulse signals
Compatible motor	Step motor (Servo/24 VDC)	Servo motor (24 VDC)	Step motor (Servo/24 VDC)	
Maximum number of step data	64 points		14 points	—
Power supply voltage	24 VDC			

\* Copper and zinc materials are used for the motors, cables, controllers/drivers.

# Electric Actuator/Slider Type Ball Screw Drive

Secondary Battery Compatible



## 25A-LEFS Series LEFS16, 25, 32, 40

Applicable to the JXC□ series

Refer to the Catalogue at [www.smc.eu](http://www.smc.eu) for model selection.

### How to Order

Refer to page 189 for the communication protocol CC-Link.

**25A-LEFS H 25 R B - 200 K - R1 CD17T**

Series compatible with secondary batteries

① ② ③ ④ ⑤ ⑥ ⑦ ⑧ ⑨ ⑩

#### ① Accuracy

—	Basic type
H	High-precision type

#### ② Size

16
25
32
40

#### ③ Motor mounting position

—	In-line
R	Right side parallel
L	Left side parallel

#### ④ Motor type

Symbol	Type	Applicable size				Compatible controller
		LEFS16	LEFS25	LEFS32	LEFS40	
—	Step motor (Servo/24 VDC)	●	●	●	●	JXCE1 JXC91 JXCP1 JXCD1

#### ⑤ Lead [mm]

Symbol	LEFS16	LEFS25	LEFS32	LEFS40
A	10	12	16	20
B	5	6	8	10

#### ⑥ Stroke [mm]

50	50
to	to
1000	1000

\* Refer to the applicable stroke table.

#### ⚠ Caution

##### [CE-compliant products]

EMC compliance was tested by combining the electric actuator LE series and the JXCE1/91/P1/D1 series.

The EMC depends on the configuration of the customer's control panel and the relationship with other electrical equipment and wiring. Therefore, conformity to the EMC directive cannot be certified for SMC components incorporated into the customer's equipment under actual operating conditions. As a result, it is necessary for the customer to verify conformity to the EMC directive for the machinery and equipment as a whole.

#### ⑦ Motor option

—	Without option
B	With lock

#### ⑧ Positioning pin hole

—	Housing B bottom*	
K	Body bottom 2 locations	

\* Refer to the body mounting example in the Catalogue at [www.smc.eu](http://www.smc.eu) for the mounting method.

#### Applicable Stroke Table

Model	Stroke [mm]	Stroke [mm]																		Manufacturable stroke range [mm]	
		50	100	150	200	250	300	350	400	450	500	550	600	650	700	750	800	850	900		950
LEFS16	●	●	●	●	●	●	●	●	●	●	—	—	—	—	—	—	—	—	—	—	50 to 500
LEFS25	●	●	●	●	●	●	●	●	●	●	●	—	—	—	—	—	—	—	—	—	50 to 600
LEFS32	●	●	●	●	●	●	●	●	●	●	●	●	●	●	●	●	—	—	—	—	50 to 800
LEFS40	—	—	●	●	●	●	●	●	●	●	●	●	●	●	●	●	●	●	●	●	150 to 1000

\* Please consult with SMC for non-standard strokes as they are produced as special orders.



# Electric Actuator/Slider Type Ball Screw Drive **25A-LEFS Series**

Step Motor (Servo/24 VDC)

Secondary Battery Compatible

Motor mounting position:  
In-line

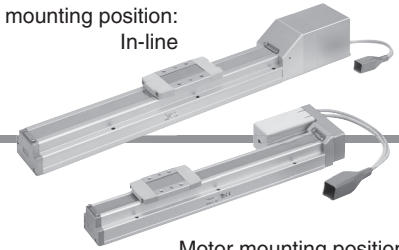

Motor mounting position:  
Right side parallel

## 9 Actuator cable type/length

—	Without cable
S1	Standard cable 1.5 m
S3	Standard cable 3 m
S5	Standard cable 5 m
R1	Robotic cable 1.5 m
R3	Robotic cable 3 m
R5	Robotic cable 5 m
R8	Robotic cable 8 m*1
RA	Robotic cable 10 m*1
RB	Robotic cable 15 m*1
RC	Robotic cable 20 m*1

\*1 Produced upon receipt of order (Robotic cable only)

\* The standard cable should only be used on fixed parts. For use on moving parts, select the robotic cable.

## 10 Controller

—	Without controller
C□1□□	With controller



Communication protocol

E	EtherCAT®
9	EtherNet/IP™
P	PROFINET
D	DeviceNet™

For single axis

Communication plug connector for DeviceNet™

—	Without plug connector
S	Straight type
T	T-branch type

\* Select “—” for anything other than DeviceNet™.

Mounting

7	Screw mounting
8*1	DIN rail

\*1 DIN rail is not included. It must be ordered separately.

\* The 25A- series specifications and dimensions are the same as those of the standard model.

## Compatible Controller

Type	EtherCAT® direct input type	EtherNet/IP™ direct input type	PROFINET direct input type	DeviceNet™ direct input type
Series	JXCE1	JXC91	JXCP1	JXCD1
Features	EtherCAT® direct input	EtherNet/IP™ direct input	PROFINET direct input	DeviceNet™ direct input
Compatible motor	Step motor (Servo/24 VDC)			
Maximum number of step data	64 points			
Power supply voltage	24 VDC			

\* Copper and zinc materials are used for the motors, cables, controllers/drivers.

# Electric Actuator/Slider Type Ball Screw Drive

Secondary Battery Compatible



## 25A-LEFS Series LEFS25, 32, 40

Refer to the Catalogue at [www.smc.eu](http://www.smc.eu) for model selection.



LECY□ Series ▶ Page 194

### How to Order

**25A-LEFS** **H** **32** **R** **S3** **B** - **200** **K** - **S** **2** **A2**

Series compatible with secondary batteries

**1 Accuracy**

—	Basic type
<b>H</b>	High-precision type

**2 Size**

<b>25</b>
<b>32</b>
<b>40</b>

**3 Motor mounting position**

—	In-line
<b>R</b>	Right side parallel
<b>L</b>	Left side parallel

**5 Lead [mm]**

Symbol	25A-LEFS25	25A-LEFS32	25A-LEFS40
<b>A</b>	12	16	20
<b>B</b>	6	8	10

**6 Stroke [mm]**

<b>50</b>	50
<b>to</b>	to
<b>1000</b>	1000

**7 Motor option**

—	Without option
<b>B</b>	With lock

**4 Motor type**

Symbol	Type	Output [W]	Actuator size	Compatible driver	UL-compliant
<b>S2</b> *1	AC servo motor	100	25	LECSA□-S1	—
<b>S3</b>	(Incremental encoder)	200	32	LECSA□-S3	—
<b>S4</b>		400	40	LECSA2-S4	—
<b>S6</b> *1	AC servo motor (Absolute encoder)	100	25	LECSB□-S5 LECS□-S5 LECSS□-S5	—
<b>S7</b>		200	32	LECSB□-S7 LECS□-S7 LECSS□-S7	—
<b>S8</b>		400	40	LECSB2-S8 LECS2-S8 LECSS2-S8	—
<b>T6</b> *2		100	25	LECSS2-T5	●
<b>T7</b>	AC servo motor (Absolute encoder)	200	32	LECSS2-T7	●
<b>T8</b>		400	40	LECSS2-T8	●

\*1 For motor type S 2 and S 6 , the compatible driver part number suffixes are S1 and S5 respectively.

\*2 For motor type T6, the compatible driver part number suffix is T5.

**12 I/O cable length [m]\*3**

—	Without cable
<b>H</b>	Without cable (Connector only)
<b>1</b>	1.5

\*3 When "Without driver" is selected for driver type, only "—: Without cable" can be selected. Refer to the **Catalogue at [www.smc.eu](http://www.smc.eu)** if I/O cable is required.

**Applicable Stroke Table**

Model	Stroke [mm]																Manufacturable stroke range [mm]				
	50	100	150	200	250	300	350	400	450	500	550	600	650	700	750	800		850	900	950	1000
25A-LEFS25	●	●	●	●	●	●	●	●	●	●	●	●	●	●	●	●	●	●	●	●	50 to 600
25A-LEFS32	●	●	●	●	●	●	●	●	●	●	●	●	●	●	●	●	●	●	●	●	50 to 800
25A-LEFS40	—	—	●	●	●	●	●	●	●	●	●	●	●	●	●	●	●	●	●	●	150 to 1000

\* Please consult with SMC for non-standard strokes as they are produced as special orders.

**8 Positioning pin hole**

—	Housing B bottom*1	
<b>K</b>	Body bottom 2 locations	

\*1 Refer to the body mounting example in the **Catalogue at [www.smc.eu](http://www.smc.eu)** for the mounting method.

**10 Cable length\* [m]**

—	Without cable
<b>2</b>	2
<b>5</b>	5
<b>A</b>	10

\* The length of the encoder, motor and lock cables are the same.

\* Refer to the applicable stroke table.

**9 Cable type\*1, \*2**

—	Without cable
<b>S</b>	Standard cable
<b>R</b>	Robotic cable (Flexible cable)

\*1 The motor and encoder cables are included. (The lock cable is also included when the motor with lock option is selected.)

\*2 Standard cable entry direction is  
 · Parallel: (A) Axis side  
 · In-line: (B) Counter axis side

**11 Driver type**

Compatible driver	Power supply voltage [V]	Size			UL-compliant
		25	32	40	
— Without driver	—	●	●	●	—
<b>A1</b> LECSA1-S□	100 to 120	●	●	—	—
<b>A2</b> LECSA2-S□	200 to 230	●	●	—	—
<b>B1</b> LECSB1-S□	100 to 120	●	●	—	—
<b>B2</b> LECSB2-S□	200 to 230	●	●	—	—
<b>C1</b> LECS□1-S□	100 to 120	●	●	—	—
<b>C2</b> LECS□2-S□	200 to 230	●	●	—	—
<b>S1</b> LECS□1-S□	100 to 120	●	●	●	—
<b>S2</b> LECS□2-S□	200 to 230	●	●	●	—
	200 to 240	●	●	●	●

\* When a driver type is selected, a cable is included. Select the cable type and cable length.  
 Example) S2S2: Standard cable (2 m) + Driver (LECS2)  
 S2 : Standard cable (2 m)  
 — : Without cable and driver

\* The 25A- series specifications and dimensions are the same as those of the standard model.

**Compatible Driver**

Driver type	Pulse input type/ Positioning type	Pulse input type	CC-Link direct input type	SSCNET# type	SSCNET III/H type
Series	LECSA	LECSB	LECS□	LECSS	LECSS-T
Number of point tables	Up to 7	—	Up to 255 (2 stations occupied)	—	—
Pulse input	○	○	—	—	—
Applicable network	—	—	CC-Link	SSCNET3	SSCNET #/H
Control encoder	Incremental 17-bit encoder	Absolute 18-bit encoder	Absolute 18-bit encoder	Absolute 18-bit encoder	Absolute 22-bit encoder
Communication function	USB communication	USB communication, RS422 communication	USB communication, RS422 communication	USB communication	
Power supply voltage [V]	100 to 120 VAC (50/60 Hz), 200 to 230 VAC (50/60 Hz)				200 to 240 VAC (50/60 Hz)

\* Copper and zinc materials are used for the motors, cables, controllers/drivers.

# Electric Actuator/Slider Type Ball Screw Drive

Secondary Battery Compatible



## 25A-LEFS Series LEFS25, 32, 40

Refer to the Catalogue at [www.smc.eu](http://www.smc.eu) for model selection.



LECS □ Series ▶ Page 193

### How to Order

**25A-LEFS H 32 R V7 B - 200 □ K - S 2 M2 □**

Series compatible with secondary batteries

**1 Accuracy**

—	Basic type
H	High-precision type

**2 Size**

25
32
40

**3 Motor mounting position**

—	In-line
R	Right side parallel
L	Left side parallel

**5 Lead [mm]**

Symbol	LEFS25	LEFS32	LEFS40
A	12	16	20
B	6	8	10

**6 Stroke [mm]**

50	50
to	to
1000	1000

**7 Motor option**

—	Without option
B	With lock

\* Refer to the applicable stroke table.

**4 Motor type**

Symbol	Type	Output [W]	Size	Compatible driver
V6*1	AC servo motor	100	25	LECYM2-V5/LECYU2-V5
V7	(Absolute encoder)	200	32	LECYM2-V7/LECYU2-V7
V8		400	40	LECYM2-V8/LECYU2-V8

\*1 For motor type V 6 , the compatible driver part number suffix is V5.

**12 I/O cable length [m]\*3**

—	Without cable
H	Without cable (Connector only)
1	1.5

\*3 When "Without driver" is selected for driver type, only "—: Without cable" can be selected. Refer to the Catalogue at [www.smc.eu](http://www.smc.eu) if I/O cable is required.

**8 Positioning pin hole**

—	Housing B bottom*1	
K	Body bottom 2 locations	

\*1 Refer to the body mounting example in the Catalogue at [www.smc.eu](http://www.smc.eu) for the mounting method.

**10 Cable length\*1 [m]**

—	Without cable
3	3
5	5
A	10
C	20

\*1 The length of the encoder, motor and lock cables are the same.

**9 Cable type\*1, \*2**

—	Without cable
S	Standard cable
R	Robotic cable (Flexible cable)

\*1 The motor and encoder cables are included. (The lock cable is also included when the motor with lock option is selected.)

\*2 Standard cable entry direction is  
· Parallel: (A) Axis side  
· In-line: (B) Counter axis side

**11 Driver type**

	Compatible driver	Power supply voltage [V]
—	Without driver	—
M2	LECYM2-V□	200 to 230
U2	LECYU2-V□	200 to 230

**Applicable Stroke Table**

Stroke [mm]	50	100	150	200	250	300	350	400	450	500	550	600	650	700	750	800	850	900	950	1000	Manufacturable stroke range [mm]	
25A-LEFS25	●	●	●	●	●	●	●	●	●	●	●	●	●	—	—	—	—	—	—	—	—	50 to 600
25A-LEFS32	●	●	●	●	●	●	●	●	●	●	●	●	●	●	●	●	●	●	●	●	●	50 to 800
25A-LEFS40	—	—	●	●	●	●	●	●	●	●	●	●	●	●	●	●	●	●	●	●	●	150 to 1000

\* Please consult with SMC for non-standard strokes as they are produced as special orders.

\* The 25A- series specifications and dimensions are the same as those of the standard model.

**Compatible Driver**

Driver type		
Series	LECYM	LECYU
Applicable network	MECHATROLINK-II	MECHATROLINK-III
Control encoder	Absolute 20-bit encoder	
Communication device	USB communication, RS-422 communication	
Power supply voltage [V]	200 to 230 VAC (50/60 Hz)	

\* Copper and zinc materials are used for the motors, cables, controllers/drivers.

# Electric Actuator/High Rigidity Slider Type Ball Screw Drive

Secondary Battery Compatible

## 25A-LEJS Series LEJS40, 63



Refer to the Catalogue at [www.smc.eu](http://www.smc.eu) for model selection.



LECY □ Series Page 196

### How to Order

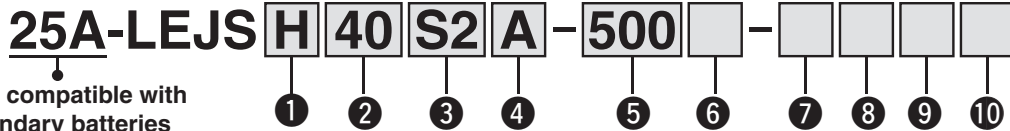

Series compatible with secondary batteries

#### ① Accuracy

—	Basic type
<b>H</b>	High-precision type

#### ② Size

<b>40</b>
<b>63</b>

#### ⑤ Stroke [mm]\*4

<b>200</b>
<b>to</b>
<b>1500</b>

\*4 Refer to the applicable stroke table for details.

#### ⑥ Motor option

—	Without option
<b>B</b>	With lock

#### ③ Motor type

Symbol	Type	Output [W]	Actuator size	Compatible driver	UL-compliant
<b>S2</b> *1	AC servo motor (Incremental encoder)	100	40	LECSA□-S1	—
<b>S3</b>	AC servo motor (Incremental encoder)	200	63	LECSA□-S3	—
<b>S6</b> *1	AC servo motor (Absolute encoder)	100	40	LECSB□-S5 LECS□-S5 LECSS□-S5	—
<b>S7</b>	AC servo motor (Absolute encoder)	200	63	LECSB□-S7 LECS□-S7 LECSS□-S7	—
<b>T6</b> *2, *3	AC servo motor (Absolute encoder)	100	40	LECSB2-T5 LECS□2-T5	—
				LECSS2-T5	●*3
<b>T7</b> *3	AC servo motor (Absolute encoder)	200	63	LECSB2-T7 LECS□2-T7	—
				LECSS2-T7	●*3
				LECSS2-T7	●*3

\*1 For motor type S2 and S6, the compatible driver part number suffixes are S1 and S5 respectively.

\*2 For motor type T6, the compatible driver part number suffix is T5.

\*3 The only compatible drivers compliant with UL standards are the LECS□2-T5 and LECS□2-T7.

#### ⑦ Cable type\*6, \*7, \*8

—	Without cable
<b>S</b>	Standard cable
<b>R</b>	Robotic cable (Flexible cable)

\*7 The motor and encoder cables are included. (The lock cable is included when the motor with lock option is selected.)

\*8 Standard cable entry is "(A) Axis side".

#### ⑧ Cable length [m]\*6, \*9

—	Without cable
<b>2</b>	2
<b>5</b>	5
<b>A</b>	10

\*9 The length of the motor, encoder and lock cables are the same.

#### Applicable Stroke Table\*5

Model	Stroke [mm]	●: Standard											
		200	300	400	500	600	700	800	900	1000	1200	1500	
<b>25A-LEJS40</b>		●	●	●	●	●	●	●	●	●	●	●	—
<b>25A-LEJS63</b>		—	●	●	●	●	●	●	●	●	●	●	●

\*5 Please consult with SMC for non-standard strokes as they are produced as special orders.

\* The 25A-series specifications and dimensions are the same as those of the standard model.

#### Compatible Driver

Driver type	Pulse input type/ Positioning type	Pulse input type	CC-Link direct input type	SSCNET III type	Pulse Input Type	CC-Link Direct Input Type	SSCNET III/H type
<b>Series</b>	<b>LECSA</b>	<b>LECSB</b>	<b>LECS□</b>	<b>LECS□</b>	<b>LECSB-T</b>	<b>LECS□-T</b>	<b>LECS□-T</b>
<b>Number of point tables</b>	Up to 7	—	Up to 255	—	Up to 255	Up to 255 (2 stations occupied)	—
<b>Pulse input</b>	○	○	—	—	○	—	—
<b>Applicable network</b>	—	—	CC-Link	SSCNET III	—	CC-Link	SSCNET III/H
<b>Control encoder</b>	Incremental 17-bit encoder	Absolute 18-bit encoder	Absolute 18-bit encoder	Absolute 18-bit encoder	Absolute 22-bit encoder	Absolute 18-bit encoder	Absolute 22-bit encoder
<b>Communication function</b>	USB communication	USB communication, RS422 communication	USB communication, RS422 communication	USB communication	USB communication, RS422 communication	USB communication, RS422 communication	USB communication
<b>Power supply voltage [V]</b>	100 to 120 VAC (50/60 Hz), 200 to 230 VAC (50/60 Hz)				200 to 240 VAC (50/60 Hz)   200 to 230 VAC (50/60 Hz)   200 to 240 VAC (50/60 Hz)		

\* Copper and zinc materials are used for the motors, cables, controllers/drivers.

For auto switches, refer to page 211.

# Electric Actuator/High Rigidity Slider Type Ball Screw Drive

Secondary Battery Compatible

## 25A-LEJS Series LEJS40, 63



Refer to the Catalogue at [www.smc.eu](http://www.smc.eu) for model selection.

LECS □ Series Page 195

### How to Order

**25A-LEJS** **H** **40** **V6** **A** - **500** □ - □ □ □ □

Series compatible with secondary batteries

**1 Accuracy**

—	Basic type
<b>H</b>	High-precision type

**2 Size**

<b>40</b>
<b>63</b>

**3 Motor type** \*1

Symbol	Type	Output [W]	Actuator size	Compatible driver
<b>V6</b>	AC servo motor (Absolute encoder)	100	40	LECYM2-V5 LECYU2-V5
<b>V7</b>	AC servo motor (Absolute encoder)	200	63	LECYM2-V7 LECYU2-V7

\*1 For motor type V6, the compatible driver part number suffix is V5.

**4 Lead [mm]**

Symbol	25A-LEJS40	25A-LEJS63
<b>H</b>	24	30
<b>A</b>	16	20
<b>B</b>	8	10

**5 Stroke [mm]**\*3

<b>200</b>
<b>to</b>
<b>1500</b>

\*3 Refer to the applicable stroke table for details.

**6 Motor option**

—	Without option
<b>B</b>	With lock

**7 Cable type**\*5, \*6, \*7

—	Without cable
<b>S</b>	Standard cable
<b>R</b>	Robotic cable (Flexible cable)

\*6 The motor and encoder cables are included. (The lock cable is included when the motor with lock option is selected.)

\*7 Standard cable entry is "(A) Axis side".

**8 Cable length [m]** \*5, \*6

—	Without cable
<b>3</b>	3
<b>5</b>	5
<b>A</b>	10
<b>C</b>	20

\*6 The length of the motor, encoder and lock cables are the same.

**9 Driver type** \*5

	Compatible driver	Power supply voltage [V]
—	Without driver	—
<b>M2</b>	LECYM2-V□	200 to 230
<b>U2</b>	LECYU2-V□	200 to 230

\*5 When a driver type is selected, a cable is included. Select the cable type and cable length.

Example)

S2S2: Standard cable (2 m) + Driver (LECSS2)

S2 : Standard cable (2 m)

— : Without cable and driver

**10 I/O cable length [m]**\*9

—	Without cable
<b>H</b>	Without cable (Connector only)
<b>1</b>	1.5

\*9 When "Without driver" is selected for driver type, only "—": Without cable" can be selected. Refer to the **Catalogue at [www.smc.eu](http://www.smc.eu)** if I/O cable is required.

**Applicable Stroke Table**\*4

Model	Stroke [mm]										
	200	300	400	500	600	700	800	900	1000	1200	1500
<b>25A-LEJS40</b>	●	●	●	●	●	●	●	●	●	●	—
<b>25A-LEJS63</b>	—	●	●	●	●	●	●	●	●	●	●

\*4 Please consult with SMC for non-standard strokes as they are produced as special orders.

●: Standard

Solid state auto switches should be ordered separately. For details about auto switches, refer to page 211.

**Applicable auto switches**

D-M9N(V)-900, D-M9P(V)-900, D-M9B(V)-900

D-M9NW(V)-900, D-M9PW(V)-900, D-M9BW(V)-900

\* The 25A- series specifications and dimensions are the same as those of the standard model.

**Compatible Driver**

Driver type	MECHATROLINK-II type	MECHATROLINK-III type
Series	<b>LECYM</b>	<b>LECYU</b>
Applicable network	MECHATROLINK-II	MECHATROLINK-III
Control encoder	Absolute 20-bit encoder	
Communication device	USB communication, RS-422 communication	
Power supply voltage [V]	200 to 230 VAC (50/60 Hz)	

\* Copper and zinc materials are used for the motors, cables, controllers/drivers.



# Electric Actuator/ Rod Type

Secondary Battery Compatible

Applicable to the  
LEC□ series

## 25A-LEY Series LEY16, 25, 32, 40



Refer to the Catalogue at [www.smc.eu](http://www.smc.eu) for model selection.

Refer to page 199 for the communication protocols  
EtherCAT®, EtherNet/IP™, PROFINET, and DeviceNet™.

### How to Order

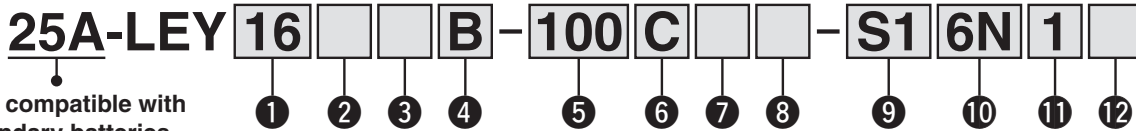

#### 1 Size

16
25
32
40

#### 2 Motor mounting position

—	Top mounting
R	Right side parallel
L	Left side parallel
D	In-line

#### 3 Motor type

Symbol	Type	Size			Compatible controller/driver
		LEY16	LEY25	LEY32/40	
—	Step motor (Servo/24 VDC)	●	●	●	LECP6 LECP1 LECPA
A	Servo motor (24 VDC)	●	●	—	LECA6

#### 4 Lead [mm]

Symbol	LEY16	LEY25	LEY32/40
A	10	12	16
B	5	6	8
C	2.5	3	4

#### 5 Stroke [mm]

30	30
to	to
500	500

\* Refer to the applicable stroke table.

#### 6 Motor option

C	With motor cover
W	With lock/motor cover

\* When "With lock/motor cover" is selected for the top mounting and right/left side parallel types, the motor body will stick out of the end of the body for size 16/40 with strokes 30 mm or less. Check for interference with workpieces before selecting a model.

#### 7 Rod end thread

—	Rod end female thread
M	Rod end male thread (1 rod end nut is included.)

#### ⚠ Caution

##### [CE-compliant products]

- EMC compliance was tested by combining the electric actuator LEY series and the controller LEC series. The EMC depends on the configuration of the customer's control panel and the relationship with other electrical equipment and wiring. Therefore, conformity to the EMC directive cannot be certified for SMC components incorporated into the customer's equipment under actual operating conditions. As a result, it is necessary for the customer to verify conformity to the EMC directive for the machinery and equipment as a whole.
- For the servo motor (24 VDC) specification, EMC compliance was tested by installing a noise filter set (LEC-NFA). Refer to the Catalogue at [www.smc.eu](http://www.smc.eu) for the noise filter set. Refer to the LECA Operation Manual for installation.

##### [UL-compliant products]

When conformity to UL is required, the electric actuator and controller/driver should be used with a UL1310 Class 2 power supply.

#### Mounting Bracket Part Nos. for the 25A- Series

Applicable size	Foot *1	Flange	Double clevis
16	25-LEY-L016	25-LEY-F016	25-LEY-D016
25	25-LEY-L025	25-LEY-F025	25-LEY-D025
32, 40	25-LEY-L032	25-LEY-F032	25-LEY-D032
Surface treatment	RAYDENT®	RAYDENT®	Coating (Size 16: Electroless nickel plating)

\*1 When ordering foot brackets, order 2 pieces per actuator.

\* Parts belonging to each bracket are as follows.

Foot, Flange: Body mounting bolt, Double clevis: Clevis pin, Type C retaining ring for axis, Body mounting bolt

\* Applicable stroke table

●: Standard

Model	Stroke [mm]										Manufacturable stroke range [mm]	
	30	50	100	150	200	250	300	350	400	450		500
LEY16	●	●	●	●	●	●	●	—	—	—	—	10 to 300
LEY25	●	●	●	●	●	●	●	●	●	—	—	15 to 400
LEY32/40	●	●	●	●	●	●	●	●	●	●	●	20 to 500

\* Please consult with SMC for non-standard strokes as they are produced as special orders.

Solid state auto switches should be ordered separately. For details about auto switches, refer to page 211.

#### Applicable auto switches

D-M9N(V)-900, D-M9P(V)-900, D-M9B(V)-900  
D-M9NW(V)-900, D-M9PW(V)-900, D-M9BW(V)-900

#### The actuator and controller/driver are sold as a package.

Confirm that the combination of the controller/driver and the actuator is correct.

<Check the following before use.>

- Check the actuator label for model number (after "25A-"). This matches the controller/driver.
- Check Parallel I/O configuration matches (NPN or PNP)

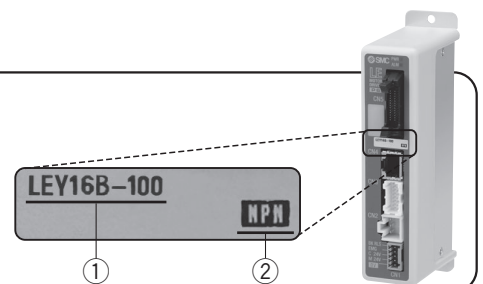

\* Refer to the operation manual for using the products. Please download it via our website, <https://www.smc.eu>

# Electric Actuator/Rod Type **25A-LEY Series**

Step Motor (Servo/24 VDC)

Servo Motor (24 VDC)

Secondary Battery Compatible

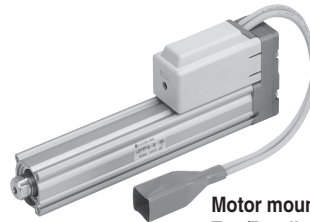

Motor mounting position:  
Top/Parallel

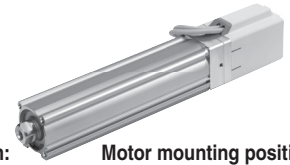

Motor mounting position:  
In-line

## 8 Mounting\*1

Symbol	Type	Motor mounting position	
		Top/Parallel	In-line
—	Ends tapped/ Body bottom tapped*2	●	●
L	Foot	●	—
F	Rod flange*2	●	●
G	Head flange*2	●*4	—
D	Double clevis*3	●	—

- \*1 Mounting bracket is shipped together, (but not assembled).
- \*2 For horizontal cantilever mounting with the rod flange, head flange and ends tapped, use the actuator within the following stroke range.
  - LEY25: 200 mm or less
  - LEY32/40: 100 mm or less
- \*3 For mounting with the double clevis, use the actuator within the following stroke range.
  - LEY16: 100 mm or less
  - LEY25: 200 mm or less
  - LEY32/40: 200 mm or less
- \*4 Head flange is not available for the LEY32/40.

## 12 Controller/Driver mounting

—	Screw mounting
D	DIN rail mounting*1

- \*1 DIN rail is not included. Order it separately.

## 9 Actuator cable type/length\*2

—	Without cable
S1	Standard cable 1.5 m*3
S3	Standard cable 3 m*3
S5	Standard cable 5 m*3
R1	Robotic cable 1.5 m
R3	Robotic cable 3 m
R5	Robotic cable 5 m
R8	Robotic cable 8 m*1
RA	Robotic cable 10 m*1
RB	Robotic cable 15 m*1
RC	Robotic cable 20 m*1

- \*1 Produced upon receipt of order (Robotic cable only)
- \*2 The standard cable should only be used on fixed parts. For use on moving parts, select the robotic cable.
- \*3 Only available for the motor type "Step motor."

## 11 I/O cable length [m]\*1, Communication plug

—	Without cable (Without communication plug connector)*3
1	1.5
3	3*2
5	5*2
S	Straight type communication plug connector*3
T	T-branch type communication plug connector*3

- \*1 When "Without controller/driver" is selected for controller/driver types, I/O cable cannot be selected. Refer to the **Catalogue at [www.smc.eu](http://www.smc.eu)** if I/O cable is required.
- \*2 When "Pulse input type" is selected for controller/driver types, pulse input usable only with differential. Only 1.5 m cables usable with open collector.
- \*3 When "CC-Link direct input type" is selected for controller/driver types, I/O cable is not included. Only "—", "S" or "T" can be selected.

\* The 25A- series specifications and dimensions are the same as those of the standard model.

## Compatible Controller/Driver

Type	Step data input type	Step data input type	Programless type	Pulse input type
Series	LECP6	LECA6	LECP1	LECPA
Features	Value (Step data) inputStandard controller		Capable of setting up operation (step data) without using a PC or teaching box	Operation by pulse signals
Compatible motor	Step motor (Servo/24 VDC)	Servo motor (24 VDC)	Step motor (Servo/24 VDC)	
Maximum number of step data	64 points		14 points	—
Power supply voltage	24 VDC			

- \* Copper and zinc materials are used for the motors, cables, controllers/drivers.



# Electric Actuator/ Rod Type

Secondary Battery Compatible



## 25A-LEY Series LEY16, 25, 32, 40

Refer to the Catalogue at [www.smc.eu](http://www.smc.eu) for model selection.

### How to Order

Refer to page 197 for the communication protocol CC-Link.

**25A-LEY 16**       **B** - **100** **C**     - **R1** **CD17T**

Series compatible with secondary batteries

① ② ③ ④ ⑤ ⑥ ⑦ ⑧ ⑨ ⑩

#### ① Size

16
25
32
40

#### ② Motor mounting position

—	Top mounting
R	Right side parallel
L	Left side parallel
D	In-line

#### ③ Motor type

Symbol	Type	Size			Compatible controller
		LEY16	LEY25	LEY32/40	
—	Step motor (Servo/24 VDC)	●	●	●	JXCE1 JXC91 JXCP1 JXCD1

#### ④ Lead [mm]

Symbol	LEY16	LEY25	LEY32/40
A	10	12	16
B	5	6	8
C	2.5	3	4

#### ⑤ Stroke [mm]

30	30
to	to
500	500

\* Refer to the applicable stroke table.

#### ⚠ Caution

##### [CE-compliant products]

EMC compliance was tested by combining the electric actuator LE series and the JXCE1/91/P1/D1 series.

The EMC depends on the configuration of the customer's control panel and the relationship with other electrical equipment and wiring. Therefore, conformity to the EMC directive cannot be certified for SMC components incorporated into the customer's equipment under actual operating conditions. As a result, it is necessary for the customer to verify conformity to the EMC directive for the machinery and equipment as a whole.

#### ⑥ Motor option

C	With motor cover
W	With lock/motor cover

\* When "With lock/motor cover" is selected for the top mounting and right/left side parallel types, the motor body will stick out of the end of the body for size 16/40 with strokes 30 mm or less. Check for interference with workpieces before selecting a model.

#### ⑦ Rod end thread

—	Rod end female thread
M	Rod end male thread (1 rod end nut is included.)

#### Mounting Bracket Part Nos. for the 25A- Series

Applicable size	Foot*1	Flange	Double clevis
16	25-LEY-L016	25-LEY-F016	25-LEY-D016
25	25-LEY-L025	25-LEY-F025	25-LEY-D025
32, 40	25-LEY-L032	25-LEY-F032	25-LEY-D032
Surface treatment	RAYDENT®	RAYDENT®	Coating (Size 16: Electroless nickel plating)

\*1 When ordering foot brackets, order 2 pieces per actuator.

\* Parts belonging to each bracket are as follows.

Foot, Flange: Body mounting bolt, Double clevis: Clevis pin, Type C retaining ring for axis, Body mounting bolt

\* Applicable Stroke Table

Model	Stroke [mm]	●: Standard										Manufacturable stroke range [mm]	
		30	50	100	150	200	250	300	350	400	450		500
LEY16		●	●	●	●	●	●	●	—	—	—	—	10 to 300
LEY25		●	●	●	●	●	●	●	●	●	—	—	15 to 400
LEY32/40		●	●	●	●	●	●	●	●	●	●	●	20 to 500

\* Please consult with SMC for non-standard strokes as they are produced as special orders.

Solid state auto switches should be ordered separately. For details about auto switches, refer to page 211.

#### Applicable auto switches

D-M9N(V)-900, D-M9P(V)-900, D-M9B(V)-900  
D-M9NW(V)-900, D-M9PW(V)-900, D-M9BW(V)-900

# Electric Actuator/Rod Type **25A-LEY Series**

Step Motor (Servo/24 VDC)

Secondary Battery Compatible

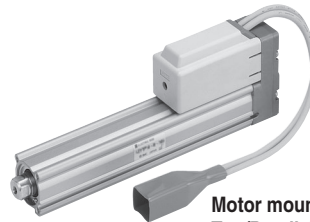

Motor mounting position:  
Top/Parallel

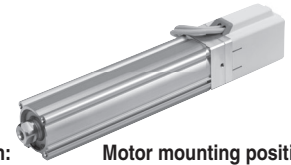

Motor mounting position:  
In-line

## 8 Mounting\*1

Symbol	Type	Motor mounting position	
		Top/Parallel	In-line
—	Ends tapped/ Body bottom tapped*2	●	●
L	Foot	●	—
F	Rod flange*2	●	●
G	Head flange*2	●*4	—
D	Double clevis*3	●	—

- \*1 Mounting bracket is shipped together, (but not assembled).
- \*2 For horizontal cantilever mounting with the rod flange, head flange and ends tapped, use the actuator within the following stroke range.
  - LEY25: 200 mm or less
  - LEY32/40: 100 mm or less
- \*3 For mounting with the double clevis, use the actuator within the following stroke range.
  - LEY16: 100 mm or less
  - LEY25: 200 mm or less
  - LEY32/40: 200 mm or less
- \*4 Head flange is not available for the LEY32/40.

## 9 Actuator cable type/length

—	Without cable
S1	Standard cable 1.5 m
S3	Standard cable 3 m
S5	Standard cable 5 m
R1	Robotic cable 1.5 m
R3	Robotic cable 3 m
R5	Robotic cable 5 m
R8	Robotic cable 8 m*1
RA	Robotic cable 10 m*1
RB	Robotic cable 15 m*1
RC	Robotic cable 20 m*1

- \*1 Produced upon receipt of order (Robotic cable only)
- \* The standard cable should only be used on fixed parts. For use on moving parts, select the robotic cable.

## 10 Controller

—	Without controller
C□1□□	With controller



Communication protocol

E	EtherCAT®
9	EtherNet/IP™
P	PROFINET
D	DeviceNet™

For single axis

Mounting

7	Screw mounting
8*1	DIN rail

- \*1 DIN rail is not included. It must be ordered separately.

Communication plug connector for DeviceNet™

—	Without plug connector
S	Straight type
T	T-branch type

- \* Select "—" for anything other than DeviceNet™.

- \* The 25A-series specifications and dimensions are the same as those of the standard model.

## Compatible Controller

Type	EtherCAT® direct input type	EtherNet/IP™ direct input type	PROFINET direct input type	DeviceNet™ direct input type
Series	JXCE1	JXC91	JXCP1	JXCD1
Features	EtherCAT® direct input	EtherNet/IP™ direct input	PROFINET direct input	DeviceNet™ direct input
Compatible motor	Step motor (Servo/24 VDC)			
Maximum number of step data	64 points			
Power supply voltage	24 VDC			

- \* Copper and zinc materials are used for the motors, cables, controllers/drivers.

# Electric Actuator/ Rod Type

Secondary Battery Compatible



## 25A-LEY Series LEY25, 32 Size 25, 32

Refer to the Catalogue at [www.smc.eu](http://www.smc.eu) for model selection.

### How to Order

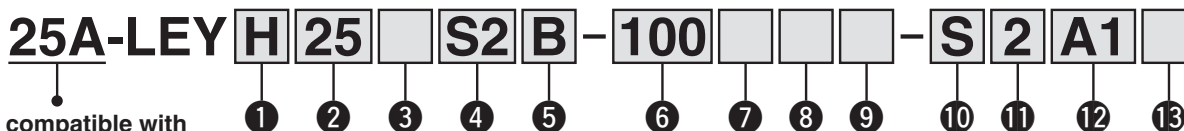

#### 1 Accuracy

—	Basic type
<b>H</b>	High-precision type

#### 2 Size

<b>25</b>
<b>32</b>

#### 3 Motor mounting position

—	Top mounting
<b>R</b>	Right side parallel
<b>L</b>	Left side parallel
<b>D</b>	In-line

#### 5 Lead [mm]

Symbol	LEY25	LEY32*1
<b>A</b>	12	16 (20)
<b>B</b>	6	8 (10)
<b>C</b>	3	4 (5)

\*1 The values shown in ( ) are the lead for size 32 top mounting, right/left side parallel types. (Equivalent lead which includes the pulley ratio [1.25:1])

#### 6 Stroke [mm]

<b>30</b>	30
<b>to</b>	to
<b>500</b>	500

\* Refer to the applicable stroke table for details.

#### 8 Rod end thread

—	Rod end female thread
<b>M</b>	Rod end male thread (1 rod end nut is included.)

#### 4 Motor type\*1

Symbol	Type	Output [W]	Actuator size	Compatible drivers*3	UL-compliant
<b>S2</b> *1	AC servo motor (Incremental encoder)	100	25	LECSA□-S1	—
<b>S3</b>		200	32	LECSA□-S3	—
<b>S6</b> *1	AC servo motor (Absolute encoder)	100	25	LECSB□-S5 LECS□-S5 LECS□-S5	—
<b>S7</b>		200	32	LECSB□-S7 LECS□-S7 LECS□-S7	—
<b>T6</b> *2	AC servo motor (Absolute encoder)	100	25	LECSS2-T5	—
<b>T7</b>		200	32	LECSS2-T7	●

\*1 For motor type S2 and S6, the compatible driver part number suffixes are S1 and S5 respectively.

\*2 For motor type T6, the compatible driver part number suffix is T5.

\*3 For details about the driver, refer to the **Catalogue at [www.smc.eu](http://www.smc.eu)**.

#### 7 Motor option

—	Without option
<b>B</b>	With lock*1

\*1 When "With lock" is selected for the top mounting and right/left side parallel types, the motor body will stick out of the end of the body for size 25 with strokes 30 mm or less. Check for interference with workpieces before selecting a model.

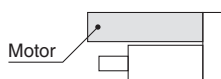

#### 9 Mounting\*1

Symbol	Type	Motor mounting position	
		Top/Parallel	In-line
—	Ends tapped/ Body bottom tapped*2	●	●
<b>L</b>	Foot	●	—
<b>F</b>	Rod flange*2	●*4	●
<b>G</b>	Head flange*2	●*5	—
<b>D</b>	Double clevis*3	●	—

\*1 Mounting bracket is shipped together, (but not assembled).

\*2 For horizontal cantilever mounting with the rod flange, head flange and ends tapped, use the actuator within the following stroke range.

- 25A-LEY25: 200 mm or less
- 25A-LEY32: 100 mm or less

\*3 For mounting with the double clevis, use the actuator within the following stroke range.

- 25A-LEY25: 200 mm or less
- 25A-LEY32: 200 mm or less

\*4 Rod flange is not available for the LEY25 with stroke 30 mm and motor option "With lock".

\*5 Head flange is not available for the 25A-LEY32.

#### Mounting Bracket Part Nos. for the 25A- Series

Applicable size	Foot*1	Flange	Double clevis
<b>25</b>	25-LEY-L025	25-LEY-F025	25-LEY-D025
<b>32</b>	25-LEY-L032	25-LEY-F032	25-LEY-D032
<b>Surface treatment</b>	RAYDENT®	RAYDENT®	Coating (Size 16: Electroless nickel plating)

\*1 When ordering foot brackets, order 2 pieces per actuator.

\* Parts belonging to each bracket are as follows.

Foot, Flange: Body mounting bolt, Double clevis: Clevis pin, Type C retaining ring for axis, Body mounting bolt

\* Applicable stroke table

Model	Stroke [mm]	●: Standard										Manufacturable stroke range [mm]	
		30	50	100	150	200	250	300	350	400	450		500
<b>25A-LEY25</b>		●	●	●	●	●	●	●	●	●	—	—	15 to 400
<b>25A-LEY32</b>		●	●	●	●	●	●	●	●	●	●	●	20 to 500

\* Please consult with SMC for non-standard strokes as they are produced as special orders.

Solid state auto switches should be ordered separately. For details about auto switches, refer to page 211.

#### Applicable auto switches

D-M9N(V)-900, D-M9P(V)-900, D-M9B(V)-900  
D-M9NW(V)-900, D-M9PW(V)-900, D-M9BW(V)-900

# Electric Actuator/Rod Type **25A-LEY Series**

AC Servo Motor

Size **25, 32**

Secondary Battery Compatible

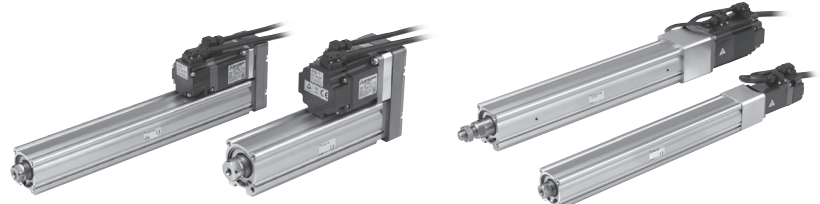

Motor mounting position:  
Top/Parallel

Motor mounting position:  
In-line

## 10 Cable type\*1

—	Without cable
<b>S</b>	Standard cable
<b>R</b>	Robotic cable (Flexible cable)

\*1 The motor and encoder cables are included. (The lock cable is also included when the motor with lock option is selected.)

\*1 Standard cable entry direction is  
 · Top/Parallel: (A) Axis side  
 · In-line: (B) Counter axis side

## 11 Cable length\*1 [m]

—	Without cable
<b>2</b>	2
<b>5</b>	5
<b>A</b>	10

\*1 The length of the encoder, motor and lock cables are the same.

## 12 Driver type\*1

	Compatible driver	Power supply voltage [V]	UL-compliant
—	Without driver	—	—
<b>A1</b>	LECSA1-S□	100 to 120	—
<b>A2</b>	LECSA2-S□	200 to 230	—
<b>B1</b>	LECSB1-S□	100 to 120	—
<b>B2</b>	LECSB2-S□	200 to 230	—
<b>C1</b>	LECSC1-S□	100 to 120	—
<b>C2</b>	LECSC2-S□	200 to 230	—
<b>S1</b>	LECSS1-S□	100 to 120	—
<b>S2</b>	LECSS2-S□	200 to 230	—
	LECSS2-T□	200 to 240	●

\*1 When a driver type is selected, a cable is included. Select the cable type and cable length.

Example)

S2S2: Standard cable (2 m) + Driver (LECSS2)

S2 : Standard cable (2 m)

— : Without cable and driver

## 13 I/O cable length [m]\*1





—	Without cable
<b>H</b>	Without cable (Connector only)
<b>1</b>	1.5

\*1 When "Without driver" is selected for driver type, only "—: Without cable" can be selected.

Refer to the **Catalogue at [www.smc.eu](http://www.smc.eu)** if I/O cable is required.

\* The 25A- series specifications and dimensions are the same as those of the standard model.

## Compatible Driver

Driver type	Pulse input type/ Positioning type	Pulse input type	CC-Link direct input type	SSCNET III type	SSCNET III/H type
					
<b>Series</b>	<b>LECSA</b>	<b>LECSB</b>	<b>LECSC</b>	<b>LECSS</b>	<b>LECSS-T</b>
<b>Number of point tables</b>	Up to 7	—	Up to 255 (2 stations occupied)	—	—
<b>Pulse input</b>	○	○	—	—	—
<b>Applicable network</b>	—	—	CC-Link	SSCNET III	SSCNET III/H
<b>Control encoder</b>	Incremental 17-bit encoder	Absolute 18-bit encoder	Absolute 18-bit encoder	Absolute 18-bit encoder	Absolute 22-bit encoder
<b>Communication function</b>	USB communication	USB communication, RS422 communication	USB communication, RS422 communication	USB communication	
<b>Power supply voltage [V]</b>	100 to 120 VAC (50/60 Hz), 200 to 230 VAC (50/60 Hz)				200 to 240 VAC (50/60 Hz)

\* Copper and zinc materials are used for the motors, cables, controllers/drivers.

# Electric Actuator/ Rod Type

Secondary Battery Compatible

**25A-LEY Series** LEY25, 32 Size 25, 32



RoHS

Refer to the Catalogue at [www.smc.eu](http://www.smc.eu) for model selection.

## How to Order

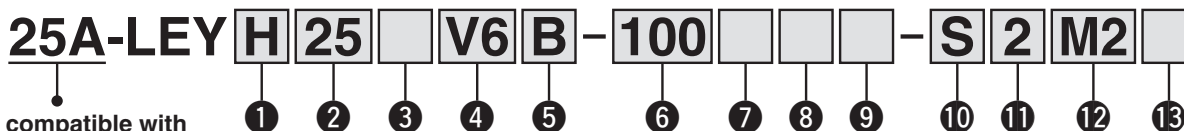

Series compatible with secondary batteries

### 1 Accuracy

—	Basic type
H	High-precision type

### 2 Size

25
32

### 3 Motor mounting position

—	Top mounting
R	Right side parallel
L	Left side parallel
D	In-line

### 4 Motor type

Symbol	Type	Output [W]	Size	Compatible driver
V6*1	AC servo motor (Absolute encoder)	100	25	LECYM2-V5 LECYU2-V5
V7		200	32	LECYM2-V7 LECYU2-V7

\*1 For motor type V6, the compatible driver part number suffix is V5.

### 5 Lead [mm]

Symbol	25A-LEY25	25A-LEY32*1
A	12	16 (20)
B	6	8 (10)
C	3	4 (5)

\*1 The values shown in ( ) are the lead for size 32 top mounting, right/left side parallel types. (Equivalent lead which includes the pulley ratio [1.25:1])

### 6 Stroke [mm]

30	30
to	to
500	500

\* Refer to the applicable stroke table for details.

### 7 Motor option

—	Without option
B	With lock*1

\*1 When "With lock" is selected for the top mounting and right/left side parallel types, the motor body will stick out of the end of the body for size 25 with strokes 30 mm or less. Check for interference with workpieces before selecting a model.

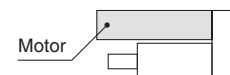

### 8 Rod end thread

—	Rod end female thread
M	Rod end male thread (1 rod end nut is included.)

### 9 Mounting\*1

Symbol	Type	Motor mounting position	
		Top/Parallel	In-line
—	Ends tapped/ Body bottom tapped *2	●	●
L	Foot	●	—
F	Rod flange*2	●*4	●
G	Head flange*2	●*5	—
D	Double clevis*3	●	—

\*1 Mounting bracket is shipped together, (but not assembled).

\*2 For horizontal cantilever mounting with the rod flange, head flange and ends tapped, use the actuator within the following stroke range.  
· LEY25: 200 mm or less · LEY32: 100 mm or less

\*3 For mounting with the double clevis, use the actuator within the following stroke range.  
· LEY25: 200 mm or less · LEY32: 200 mm or less

\*4 Rod flange is not available for the LEY25 with stroke 30 mm and motor option "With lock".

\*5 Head flange is not available for the LEY32.

### Mounting Bracket Part Nos. for the 25A- Series

Applicable size	Foot*1	Flange	Double clevis
25	25-LEY-L025	25-LEY-F025	25-LEY-D025
32	25-LEY-L032	25-LEY-F032	25-LEY-D032
Surface treatment	RAYDENT®	RAYDENT®	Coating (Size 16: Electroless nickel plating)

Solid state auto switches should be ordered separately. For details about auto switches, refer to page 211.

\*1 When ordering foot brackets, order 2 pieces per actuator.

\* Parts belonging to each bracket are as follows.

Foot, Flange: Body mounting bolt, Double clevis: Clevis pin, Type C retaining ring for axis, Body mounting bolt

\* Applicable stroke table

Model	Stroke [mm]												Manufacturable stroke range [mm]
		30	50	100	150	200	250	300	350	400	450	500	
25A-LEY25		●	●	●	●	●	●	●	●	●	—	—	15 to 400
25A-LEY32		●	●	●	●	●	●	●	●	●	●	●	20 to 500

\* Please consult with SMC for non-standard strokes as they are produced as special orders.

# Electric Actuator/Rod Type **25A-LEY Series**

AC Servo Motor

Size **25, 32**

Secondary Battery Compatible

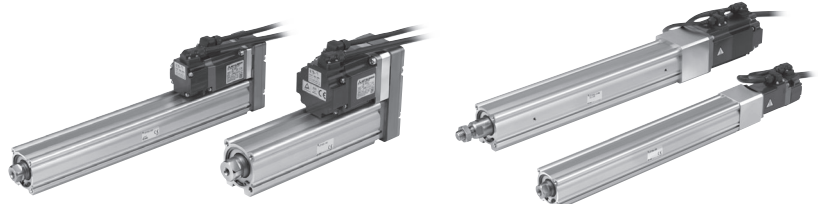

Motor mounting position:  
Top/Parallel

Motor mounting position:  
In-line

## 10 Cable type\*1

—	Without cable
<b>S</b>	Standard cable
<b>R</b>	Robotic cable (Flexible cable)

\*1 The motor and encoder cables are included. (The lock cable is also included when the motor with lock option is selected.)

\*1 Standard cable entry direction is  
· Top/Parallel: (A) Axis side  
· In-line: (B) Counter axis side

## 11 Cable length [m]\*1

—	Without cable
<b>3</b>	3
<b>5</b>	5
<b>A</b>	10
<b>C</b>	20

\*1 The length of the motor and encoder cables are the same. (For with lock)

## 12 Driver type

	Compatible driver	Power supply voltage [V]
—	Without driver	—
<b>M2</b>	LECYM2-V□	200 to 230
<b>U2</b>	LECYU2-V□	200 to 230

\* When a driver type is selected, a cable is included. Select the cable type and cable length.



## 13 I/O cable length [m]\*1

—	Without cable
<b>H</b>	Without cable (Connector only)
<b>1</b>	1.5

\*1 When "Without driver" is selected for driver type, only "—: Without cable" can be selected. Refer to the **Catalogue at [www.smc.eu](http://www.smc.eu)** if I/O cable is required.

\* The 25A- series specifications and dimensions are the same as those of the standard model.

## Compatible Driver

Driver type	 MECHATROLINK-II type	 MECHATROLINK-III type
	Series	<b>LECYM</b>
Applicable network	MECHATROLINK-II	MECHATROLINK-III
Control encoder	Absolute 20-bit encoder	
Communication device	USB communication, RS-422 communication	
Power supply voltage [V]	200 to 230 VAC (50/60 Hz)	

\* Copper and zinc materials are used for the motors, cables, controllers/drivers.



# 25A- Series

# Applicable Auto Switches

## Applicable Cylinder Series

Type	Special function	Electrical entry	Indicator light	Auto switches					Air cylinders										
				Wiring (Output)	Electrical entry direction	Auto switch model	Lead wire length [m]				Pre-wired connector SDPC	CDJP2 Ø 4 to Ø 16	CD(B)J2 CDJ2K Ø 10, Ø 16	CDM2 Ø 20 to Ø 40	CD(B)G1 Ø 20 to Ø 63 Ø 80, Ø 100	MDB Ø 32 to Ø 100	CDA2 Ø 40 to Ø 100		
							0.5 —	1 M	3 L	5 Z									
Solid state auto switch	—	Grommet	Yes	3-wire (NPN)	In-line	D-M9N-900	●	●	●	○	—	●	●	●	●	—	●	●	
				3-wire (PNP)		D-M9P-900	●	●	●	○	—	●	●	●	●	—	●	●	
				2-wire		D-M9B-900	●	●	●	○	—	●	●	●	●	—	●	●	
				3-wire (NPN)		Perpendicular	D-M9NV-900	●	●	●	○	—	●	—	—	—	—	●	●
				3-wire (PNP)			D-M9PV-900	●	●	●	○	—	●	—	—	—	—	●	●
				2-wire			D-M9BV-900	●	●	●	○	—	●	—	—	—	—	●	●
				3-wire (NPN)	In-line		D-M9NW-900	●	●	●	○	—	●	●	●	●	—	●	●
				3-wire (PNP)			D-M9PW-900	●	●	●	○	—	●	●	●	●	—	●	●
				2-wire			D-M9BW-900	●	●	●	○	○	●	●	●	●	—	●	●
				3-wire (NPN)		Perpendicular	D-M9NVV-900	●	●	●	○	—	●	—	—	—	—	●	●
				3-wire (PNP)			D-M9PVV-900	●	●	●	○	—	●	—	—	—	—	●	●
				2-wire			D-M9BVV-900	●	●	●	○	○	●	—	—	—	—	●	●
	3-wire (NPN)			In-line	D-Y59A-900		●	●	●	○	—	—	—	—	—	—	—	—	
	3-wire (PNP)				D-Y59P-900		●	●	●	○	—	—	—	—	—	—	—	—	
	2-wire				D-Y59B-900		●	●	●	○	—	—	—	—	—	—	—	—	
	3-wire (NPN)				Perpendicular	D-Y69A-900	●	●	●	○	—	—	—	—	—	—	—	—	
	3-wire (PNP)					D-Y69P-900	●	●	●	○	—	—	—	—	—	—	—	—	
	2-wire					D-Y69B-900	●	●	●	○	—	—	—	—	—	—	—	—	
	3-wire (NPN)			In-line		D-Y79A-900	●	●	●	○	—	—	—	—	—	—	—	—	
	3-wire (PNP)					D-Y79P-900	●	●	●	○	—	—	—	—	—	—	—	—	
	2-wire					D-Y79B-900	●	●	●	○	—	—	—	—	—	—	—	—	
	3-wire (NPN)				Perpendicular	D-Y79V-900	●	●	●	○	—	—	—	—	—	—	—	—	
	3-wire (PNP)					D-Y79PV-900	●	●	●	○	—	—	—	—	—	—	—	—	
	2-wire					D-Y79BV-900	●	●	●	○	—	—	—	—	—	—	—	—	
	3-wire (NPN)	In-line	D-Y79W-900	●		●	●	○	—	—	—	—	—	—	—	—			
	3-wire (PNP)		D-Y79PW-900	●		●	●	○	—	—	—	—	—	—	—	—			
	2-wire		D-Y79BW-900	●		●	●	○	—	—	—	—	—	—	—	—			
	3-wire (NPN)		Perpendicular	D-G59A-900	●	—	●	○	—	—	—	—	—	—	●	—			
	3-wire (PNP)			D-G59P-900	●	—	●	○	—	—	—	—	—	—	●	—			
	2-wire			D-K59-900	●	—	●	○	—	—	—	—	—	—	●	—			
	3-wire (NPN)	In-line		D-G59W-900	●	—	●	○	—	—	—	—	—	—	●	—			
	3-wire (PNP)			D-G59PW-900	●	—	●	○	—	—	—	—	—	—	●	—			
	2-wire			D-K59W-900	●	—	●	○	○	—	—	—	—	—	●	—			
	3-wire (NPN)		In-line	D-F79-900	●	—	●	○	—	—	—	—	—	—	—	—			
	3-wire (PNP)			D-F79P-900	●	—	●	○	—	—	—	—	—	—	—	—			
	2-wire			D-J79-900	●	—	●	○	—	—	—	—	—	—	—	—			
	3-wire (NPN)	Perpendicular		D-F79V-900	●	—	●	○	—	—	—	—	—	—	—	—			
	3-wire (PNP)			D-F79PV-900	●	—	●	○	—	—	—	—	—	—	—	—			
	2-wire			D-F79BV-900	●	—	●	○	—	—	—	—	—	—	—	—			
	3-wire (NPN)		In-line	D-F79W-900	●	—	●	○	—	—	—	—	—	—	—	—			
	3-wire (PNP)			D-F79PW-900	●	—	●	○	—	—	—	—	—	—	—	—			
	2-wire			D-J79W-900	●	—	●	○	—	—	—	—	—	—	—	—			
	3-wire (NPN)	Perpendicular		D-F79WV-900	●	—	●	○	—	—	—	—	—	—	—	—			
	3-wire (PNP)			D-F79WV-900	●	—	●	○	—	—	—	—	—	—	—	—			
	2-wire			D-F8N-900	●	—	●	○	—	—	—	—	—	—	—	—			
	3-wire (NPN)		In-line	D-F8N-900	●	—	●	○	—	—	—	—	—	—	—	—			
	3-wire (PNP)			D-F8P-900	●	—	●	○	—	—	—	—	—	—	—	—			
	2-wire			D-F8B-900	●	—	●	○	—	—	—	—	—	—	—	—			
3-wire (NPN)	Perpendicular	D-A90-900		—	—	●	—	—	—	●*1	●	●	●	—	—	●			
3-wire (PNP)		D-Z80-900		—	—	●	—	—	—	—	—	—	—	—	—	—			
2-wire		D-E76A		●	—	●	—	—	—	—	—	—	—	—	—	—			
3-wire (NPN equiv.)		D-E73A	●	—	●	—	—	—	—	—	—	—	—	—	—				
3-wire (PNP)		D-E80A	●	—	●	—	—	—	—	—	—	—	—	—	—				
2-wire		D-E80A	●	—	●	—	—	—	—	—	—	—	—	—	—				

\*1 The D-A90L-900 cannot be mounted on Ø 4. \* Solid state auto switches marked with "○" are produced upon receipt of order.

### Ordering the Auto Switches

Please be aware that the order part numbers for the cylinder mounted and individual auto switches are different.

(Example) Part number for ordering D-M9BWL-900:

- Cylinder mounted type: 25A-CDJ2L16-60-M9BWL  
(Omit the first "D-" and the last "-900" or "-901".)
- Individual auto switch: D-M9BWL-900  
(Place the order with the part number for auto switch shown in the table above.)

- \* Lead wire length symbols: 0.5 m..... — (Example) M9NW
- 1 m..... M (Example) M9NWM
- 3 m..... L (Example) M9NWL
- 5 m..... Z (Example) M9NWZ





# 25A- Series

## Applicable Cylinder Series

Auto switches														
Type	Special function	Electrical entry	Indicator light	Wiring (Output)	Electrical entry direction	Auto switch model	Lead wire length [m]				Pre-wired connector			
							0.5	1	3	5				
							—	M	L	Z	SDPC			
Solid state auto switch	—	Grommet	Yes	3-wire (NPN)	In-line	D-M9N-900	●	●	●	○	—			
				3-wire (PNP)		D-M9P-900	●	●	●	○	—			
				2-wire	Perpendicular	D-M9B-900	●	●	●	○	—			
				3-wire (NPN)		D-M9NV-900	●	●	●	○	—			
				3-wire (PNP)	D-M9PV-900	●	●	●	○	—				
				2-wire	D-M9BV-900	●	●	●	○	—				
	Diagnostic indication (2-colour indicator)			3-wire (NPN)	In-line	D-M9NW-900	●	●	●	○	—			
				3-wire (PNP)		D-M9PW-900	●	●	●	○	—			
				2-wire	Perpendicular	D-M9BW-900	●	●	●	○	○			
				3-wire (NPN)		D-M9NWV-900	●	●	●	○	—			
				3-wire (PNP)	D-M9PWV-900	●	●	●	○	—				
				2-wire	D-M9BWB-900	●	●	●	○	○				
	—			3-wire (NPN)	In-line	D-Y59A-900	●	●	●	○	—			
				3-wire (PNP)		D-Y7P-900	●	●	●	○	—			
				2-wire	Perpendicular	D-Y59B-900	●	●	●	○	—			
				3-wire (NPN)		D-Y69A-900	●	●	●	○	—			
				3-wire (PNP)	D-Y7PV-900	●	●	●	○	—				
				2-wire	D-Y69B-900	●	●	●	○	—				
	Diagnostic indication (2-colour indicator)			3-wire (NPN)	In-line	D-Y7NW-900	●	●	●	○	—			
				3-wire (PNP)		D-Y7PW-900	●	●	●	○	—			
				2-wire	Perpendicular	D-Y7BW-900	●	●	●	○	—			
				3-wire (NPN)		D-Y7NWV-900	●	●	●	○	—			
				3-wire (PNP)	D-Y7PWV-900	●	●	●	○	—				
				2-wire	D-Y7BWB-900	●	●	●	○	—				
	—			3-wire (NPN)	In-line	D-G59-900	●	—	●	○	—			
				3-wire (PNP)		D-G5P-900	●	—	●	○	—			
				2-wire	Perpendicular	D-K59-900	●	—	●	○	—			
				3-wire (NPN)		D-G59W-900	●	—	●	○	—			
				3-wire (PNP)	D-G5PW-900	●	—	●	○	—				
				2-wire	D-K59W-900	●	—	●	○	○				
	—			3-wire (NPN)	In-line	D-F79-900	●	—	●	○	—			
				3-wire (PNP)		D-F7P-900	●	—	●	○	—			
				2-wire	Perpendicular	D-J79-900	●	—	●	○	—			
				3-wire (NPN)		D-F7NV-900	●	—	●	○	—			
				3-wire (PNP)	D-F7PV-900	●	—	●	○	—				
				2-wire	In-line	D-F7BV-900	●	—	●	○	—			
				3-wire (NPN)		D-F79W-900	●	—	●	○	—			
				3-wire (PNP)	D-F7PW-900	●	—	●	○	—				
				2-wire	Perpendicular	D-J79W-900	●	—	●	○	—			
				3-wire (NPN)		D-F7NWV-900	●	—	●	○	—			
				2-wire	D-F7BWB-900	●	—	●	○	—				
				Diagnostic indication (2-colour indicator)	3-wire (NPN)	In-line	D-F8N-900	●	—	●	○	—		
	3-wire (PNP)				D-F8P-900		●	—	●	○	—			
	2-wire				Perpendicular	D-F8B-900	●	—	●	○	—			
	3-wire (NPN)					D-E79-900	—	—	●	—	—			
	Reed auto switch			—	Grommet	No	2-wire	In-line	D-Z80-900	—	—	●	—	—
						Yes	3-wire (NPN equiv.)	In-line	D-E76A	●	—	●	—	—
				No		2-wire	D-E73A		●	—	●	—	—	
			D-E80A	●		—	●	—	—					



# 25A- Series

## Applicable Rotary Actuator Series

Type	Special function	Electrical entry	Indicator light	Auto switches					Rotary actuators								
				Wiring (Output)	Electrical entry direction	Auto switch model	Lead wire length [m]				Pre-wired connector	MSQ	MSZ	MDSUB			
							0.5	1	3	5				10 to 200	10 to 50	1, 3	7, 20
								—	M	L	Z	SDPC					
Solid state auto switch	—	Grommet	Yes	3-wire (NPN)	In-line	D-M9N-900	●	●	●	○	—	●	●	—	—		
						D-M9P-900	●	●	●	○	—	●	●	—	—		
						2-wire	D-M9B-900	●	●	●	○	—	●	●	—	—	
						3-wire (NPN)	Perpendicular	D-M9NV-900	●	●	●	○	—	●	●	—	—
								D-M9PV-900	●	●	●	○	—	●	●	—	—
								2-wire	D-M9BV-900	●	●	●	○	—	●	●	—
				3-wire (PNP)	In-line	D-M9NW-900	●	●	●	○	—	●	●	—	—		
						D-M9PW-900	●	●	●	○	—	●	●	—	—		
						2-wire	D-M9BW-900	●	●	●	○	○	●	●	—	—	
						3-wire (NPN)	Perpendicular	D-M9NWV-900	●	●	●	○	—	●	●	—	—
								D-M9PWV-900	●	●	●	○	—	●	●	—	—
								2-wire	D-M9BWV-900	●	●	●	○	○	●	●	—
	3-wire (PNP)	In-line	D-Y59A-900	●	●	●	○	—	—	—	—	—					
			D-Y7P-900	●	●	●	○	—	—	—	—	—					
			2-wire	D-Y59B-900	●	●	●	○	—	—	—	—	—				
			3-wire (NPN)	Perpendicular	D-Y69A-900	●	●	●	○	—	—	—	—	—			
					D-Y7PV-900	●	●	●	○	—	—	—	—	—			
					2-wire	D-Y69B-900	●	●	●	○	—	—	—	—	—		
	3-wire (PNP)	In-line	D-Y7NW-900	●	●	●	○	—	—	—	—	—					
			D-Y7PW-900	●	●	●	○	—	—	—	—	—					
			2-wire	D-Y7BW-900	●	●	●	○	—	—	—	—	—				
			3-wire (NPN)	Perpendicular	D-Y7NWV-900	●	●	●	○	—	—	—	—	—			
					D-Y7PWV-900	●	●	●	○	—	—	—	—	—			
					2-wire	D-Y7BWV-900	●	●	●	○	—	—	—	—	—		
	Diagnostic indication (2-colour indicator)	Grommet	Yes	3-wire (NPN)	In-line	D-S991-901*1	●	—	●	○	—	—	—	●	—		
						D-S992-901*1	●	—	●	○	—	—	—	●	—		
						3-wire (PNP)	D-S9P1-901*1	●	—	●	○	—	—	—	●	—	
						D-S9P2-901*1	●	—	●	○	—	—	—	●	—		
						2-wire	D-T991-901*1	●	—	●	○	—	—	—	●	—	
							D-T992-901*1	●	—	●	○	—	—	—	●	—	
		3-wire (PNP)		Perpendicular	D-S99V1-901*1	●	—	●	○	—	—	—	●	—			
					D-999V2-901*1	●	—	●	○	—	—	—	●	—			
					D-S9PV1-901*1	●	—	●	○	—	—	—	●	—			
					D-S9PV2-901*1	●	—	●	○	—	—	—	●	—			
					2-wire	D-T99V1-901*1	●	—	●	○	—	—	—	●	—		
						D-T99V2-901*1	●	—	●	○	—	—	—	●	—		
	3-wire (NPN)	In-line	D-S791-901*1	●	—	●	○	—	—	—	—	●					
			D-S792-901*1	●	—	●	○	—	—	—	—	●					
			3-wire (PNP)	D-S7P1-901*1	●	—	●	○	—	—	—	—	●				
			D-S7P2-901*1	●	—	●	○	—	—	—	—	—	●				
2-wire			D-T791-901*1	●	—	●	○	—	—	—	—	●					
			D-T792-901*1	●	—	●	○	—	—	—	—	●					
Reed auto switch	—	Grommet	No	2-wire	In-line	D-A90-900	—	—	●	—	—	●	●	—	—		

\* Solid state auto switches marked with "○" are produced upon receipt of order.

\* Note that the individual auto switch with part number of "S□□" and "T□□" have the right-hand-type (□□□1) and the left-hand-type (□□□2).

When you order the actuator with two auto switches at the part number of the actuator, one each of the right-hand-type and the left-hand-type are shipped together with the actuator.

\* When the MHZ2-10, MHZL2-10, MHL2-10 to 40, or MHS3-32 air gripper is ordered with auto switch, mounting brackets are supplied with the air gripper.

When the auto switch is used at the square groove on the side with other cylinder bore sizes, or ordering only auto switches separately, mounting brackets (90-BMG2-012) are required. Order them separately. For details, refer to page 214.

### Ordering the Auto Switches

Please be aware that the order part numbers for the rotary actuator mounted and individual auto switches are different.  
 (Example) Part number for ordering D-M9BWL-900:

- Rotary actuator mounted type: 25A-MSQB-10A-M9BWL
- Individual auto switch: D-M9BWL-900  
(Place the order with the part number for auto switch shown in the table above.)

\* Lead wire length symbols: 0.5 m..... — (Example) M9NW  
 1 m..... M (Example) M9NWM  
 3 m..... L (Example) M9NWL  
 5 m..... Z (Example) M9NWX

\*1 Lead wire for a solid state auto switch with "-901" at the end of part number has been changed to a cable for a robot use.

**Applicable Air Gripper Series**

Auto switches							Air grippers																			
Type	Special function	Electrical entry	Indicator light	Wiring (Output)	Electrical entry direction	Auto switch model	Lead wire length [m]				Pre-wired connector	MHZ2	MHZL2	MHZJ2	MHZJ2-X6100	MHZL2-X5955	MHL2	MHF2	MHS3	MHS4	MHSJ3	MHY2				
							0.5	1	3	5																
							—	M	L	Z	SDPC	10 to 40	10 to 25	10 to 25	32, 40	10 to 20	10 to 40	8 to 20	16 to 32	16 to 32	16 to 25					
Solid state auto switch	Diagnostic indication (2-colour indicator)	Grommet	Yes	3-wire (NPN)	In-line	D-M9N-900	●	●	●	○	—	●	●	●	●	●	●	●	●	●	●	●				
						D-M9P-900	●	●	●	○	—	●	●	●	●	●	●	●	●	●	●	●	●	●	●	
						2-wire	D-M9B-900	●	●	●	○	—	●	●	●	●	●	●	●	●	●	●	●	●	●	●
						3-wire (NPN)	D-M9NV-900	●	●	●	○	—	●	●	●	●	●	●	●	●	●	●	●	●	●	●
						3-wire (PNP)	D-M9PV-900	●	●	●	○	—	●	●	●	●	●	●	●	●	●	●	●	●	●	●
						2-wire	D-M9BV-900	●	●	●	○	—	●	●	●	●	●	●	●	●	●	●	●	●	●	●
				3-wire (NPN)	In-line	D-M9NW-900	●	●	●	○	—	●	●	●	●	●	●	●	●	●	●	●	●	●	●	
						3-wire (PNP)	D-M9PW-900	●	●	●	○	—	●	●	●	●	●	●	●	●	●	●	●	●	●	
						2-wire	D-M9BW-900	●	●	●	○	○	●	●	●	●	●	●	●	●	●	●	●	●	●	●
						3-wire (NPN)	D-M9NWV-900	●	●	●	○	—	●	●	●	●	●	●	●	●	●	●	●	●	●	●
						3-wire (PNP)	D-M9PWV-900	●	●	●	○	—	●	●	●	●	●	●	●	●	●	●	●	●	●	●
						2-wire	D-M9B WV-900	●	●	●	○	○	●	●	●	●	●	●	●	●	●	●	●	●	●	●
	3-wire (NPN)	In-line	D-Y59A-900	●	●	●	○	—	●	●	—	—	—	—	—	●	—	—	—	—	—	—				
			3-wire (PNP)	D-Y7P-900	●	●	●	○	—	●	●	—	—	—	—	—	●	—	—	—	—	—				
			2-wire	D-Y59B-900	●	●	●	○	—	●	●	—	—	—	—	—	●	—	—	—	—	—				
			3-wire (NPN)	D-Y69A-900	●	●	●	○	—	●	●	—	—	—	—	—	●	—	—	—	—	—				
			3-wire (PNP)	D-Y7PV-900	●	●	●	○	—	●	●	—	—	—	—	—	●	—	—	—	—	—				
			2-wire	D-Y69B-900	●	●	●	○	—	●	●	—	—	—	—	—	●	—	—	—	—	—				
	3-wire (NPN)	In-line	D-Y7NW-900	●	●	●	○	—	●	●	—	—	—	—	—	●	—	—	—	—	—					
			3-wire (PNP)	D-Y7PW-900	●	●	●	○	—	●	●	—	—	—	—	●	—	—	—	—	—					
			2-wire	D-Y7BW-900	●	●	●	○	—	●	●	—	—	—	—	●	—	—	—	—	—					
			3-wire (NPN)	D-Y7NVV-900	●	●	●	○	—	●	●	—	—	—	—	—	●	—	—	—	—					
			3-wire (PNP)	D-Y7P WV-900	●	●	●	○	—	●	●	—	—	—	—	—	●	—	—	—	—					
			2-wire	D-Y7B WV-900	●	●	●	○	—	●	●	—	—	—	—	—	●	—	—	—	—					
	3-wire (NPN)	In-line	D-S991-901*1	●	—	●	○	—	—	—	—	—	—	—	—	—	—	—	—	—	—					
			D-S992-901*1	●	—	●	○	—	—	—	—	—	—	—	—	—	—	—	—	—	—					
			3-wire (PNP)	D-S9P1-901*1	●	—	●	○	—	—	—	—	—	—	—	—	—	—	—	—	—					
			2-wire	D-S9P2-901*1	●	—	●	○	—	—	—	—	—	—	—	—	—	—	—	—	—					
			D-T991-901*1	●	—	●	○	—	—	—	—	—	—	—	—	—	—	—	—	—	—					
			D-T992-901*1	●	—	●	○	—	—	—	—	—	—	—	—	—	—	—	—	—	—					
3-wire (NPN)			D-S99V1-901*1	●	—	●	○	—	—	—	—	—	—	—	—	—	—	—	—	—						
D-999V2-901*1			●	—	●	○	—	—	—	—	—	—	—	—	—	—	—	—	—	—						
3-wire (PNP)			D-S9PV1-901*1	●	—	●	○	—	—	—	—	—	—	—	—	—	—	—	—	—						
D-S9PV2-901*1			●	—	●	○	—	—	—	—	—	—	—	—	—	—	—	—	—	—						
2-wire			D-T99V1-901*1	●	—	●	○	—	—	—	—	—	—	—	—	—	—	—	—	—						
D-T99V2-901*1			●	—	●	○	—	—	—	—	—	—	—	—	—	—	—	—	—	—						
3-wire (NPN)	In-line	D-S791-901*1	●	—	●	○	—	—	—	—	—	—	—	—	—	—	—	—	—							
		D-S792-901*1	●	—	●	○	—	—	—	—	—	—	—	—	—	—	—	—	—							
		3-wire (PNP)	D-S7P1-901*1	●	—	●	○	—	—	—	—	—	—	—	—	—	—	—	—							
		D-S7P2-901*1	●	—	●	○	—	—	—	—	—	—	—	—	—	—	—	—	—							
		2-wire	D-T791-901*1	●	—	●	○	—	—	—	—	—	—	—	—	—	—	—	—							
		D-T792-901*1	●	—	●	○	—	—	—	—	—	—	—	—	—	—	—	—	—							
Reed auto switch	—	Grommet	No	2-wire	In-line	D-A90-900	—	—	●	—	—	—	—	—	—	—	—	—	—							

- \* Solid state auto switches marked with "○" are produced upon receipt of order.
- \* Note that the individual auto switch with part number of "S□□" and "T□□" have the right-hand-type (□□□1) and the left-hand-type (□□□2).  
When you order the actuator with two auto switches at the part number of the actuator, one each of the right-hand-type and the left-hand-type are shipped together with the actuator.
- \* When the MHZ2-10, MHZL2-10, MHL2-10 to 40, or MHS3-32 air gripper is ordered with auto switch, mounting brackets are supplied with the air gripper.  
When the auto switch is used at the square groove on the side with other cylinder bore sizes, or ordering only auto switches separately, mounting brackets (90-BMG2-012) are required. Order them separately. For details, refer to page 214.

**Ordering the Auto Switches**

Please be aware that the order part numbers for the air gripper mounted and individual auto switches are different.  
 (Example) Part number for ordering D-M9BWL-900:

• Air gripper mounted type: 25A-MHZ2-16D-M9BWL (Omit the first "D-" and the last "-900" or "-901".)	* Lead wire length symbols: 0.5 m..... — (Example) M9NW 1 m..... M (Example) M9NWM 3 m..... L (Example) M9NWL 5 m..... Z (Example) M9NWZ
• Individual auto switch: D-M9BWL-900 (Place the order with the part number for auto switch shown in the table above.)	

\*1 Lead wire for a solid state auto switch with "-901" at the end of part number has been changed to a cable for a robot use.

# 25A- Series

## Applicable Electric Actuator Series

Auto switches										Electric actuators			
Type	Special function	Electrical entry	Indicator light	Wiring (Output)	Electrical entry direction	Auto switch model	Lead wire length [m]				Pre-wired connector SDPC	LEJS	LEY
							0.5 —	1 M	3 L	5 Z		40 to 63	16 to 40
Solid state auto switch	—	Grommet	Yes	3-wire (NPN)	In-line	D-M9N-900	●	●	●	○	—	●	●
				3-wire (PNP)		D-M9P-900	●	●	●	○	—	●	●
				2-wire		D-M9B-900	●	●	●	○	—	●	●
				3-wire (NPN)	Perpendicular	D-M9NV-900	●	●	●	○	—	●	●
				3-wire (PNP)		D-M9PV-900	●	●	●	○	—	●	●
				2-wire		D-M9BV-900	●	●	●	○	—	●	●
	Diagnostic indication (2-colour indicator)	Grommet	Yes	3-wire (NPN)	In-line	D-M9NW-900	●	●	●	○	—	●	●
				3-wire (PNP)		D-M9PW-900	●	●	●	○	—	●	●
				2-wire		D-M9BW-900	●	●	●	○	○	●	●
				3-wire (NPN)	Perpendicular	D-M9NWV-900	●	●	●	○	—	●	●
				3-wire (PNP)		D-M9PWV-900	●	●	●	○	—	●	●
				2-wire		D-M9BWV-900	●	●	●	○	○	●	●

\* Solid state auto switches marked with "○" are produced upon receipt of order.

\* Auto switches cannot be ordered with the actuator part number. They should be ordered separately. Please refer below for ordering.  
One each of the right-hand-type and the left-hand-type are shipped together with the actuator.

### Ordering the Auto Switches

- Individual auto switch: D-M9BWL-900  
(Place the order with the part number for auto switch shown in the table above.)
- \* Lead wire length symbols: 0.5 m..... — (Example) M9NW  
1 m..... M (Example) M9NWM  
3 m..... L (Example) M9NWL  
5 m..... Z (Example) M9NWZ

# 25A- Series Auto Switch Mounting

## Band Mounting Type

Applicable cylinder series: 25A-CDJ2, 25A-CDJ2K, 25A-CDBJ2, 25A-CDM2, 25A-CDG1, 25A-CDBG1, 25A-MGG  
 Applicable auto switches : D-M9□-900, D-M9□W-900, D-M9BWSVSDPC-900, D-M9BWSVSDPC-900, D-A90-900

### Auto Switch Mounting Bracket Part Nos.

Cylinder series	Applicable bore size [mm]									
	10	16	20	25	32	40	50	63	80	100
25A-CDJ2 25A-CDJ2K 25A-CDBJ2	*1 25A-BJ7-010S	*1 25A-BJ7-016S	—	—	—	—	—	—	—	—
25A-CDM2	—	—	*2 25A-BM6-020S	*2 25A-BM6-025S	*2 25A-BM6-032S	*2 25A-BM6-040S	—	—	—	—
25A-CDG1 25A-CDBG1	—	—	*3 25A-BMA4-020S	*3 25A-BMA4-025S	*3 25A-BMA4-032S	*3 25A-BMA4-040S	*3 25A-BMA4-050S	*3 25A-BMA4-063S	—	—
25A-MGG	—	—	*3 25A-BMA4-020S	*3 25A-BMA4-025S	*3 25A-BMA4-032S	*3 25A-BMA4-040S	*3 25A-BMA4-050S	*3 25A-BMA4-063S	—	—

- \*1 The combination of the auto switch mounting band (BJ2-□□□S/with a stainless steel screw) and the holder set (BJ3-1).
- \*2 The combination of the auto switch mounting band (for BM2-□□□) and stainless steel screw (BBA4), and the holder set (BJ3-1).
- \*3 The combination of the auto switch mounting band (for BMA2-□□□) and stainless steel screw (BBA4), and the holder set (BJ3-1).

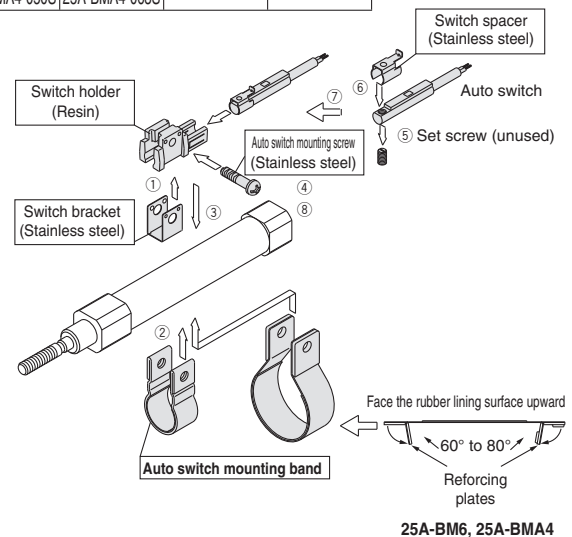

Applicable cylinder series: 25A-CDG1, 25A-CDBG1  
 Applicable auto switches : D-G5□-900, D-K59-900, D-G5□W-900, D-K59W-900, D-K59WSVSDPC-900

### Auto Switch Mounting Bracket Part Nos.

Cylinder series	Applicable bore size [mm]	
	80	100
25A-CDG1 25A-CDBG1	BA-08S	BA-10S

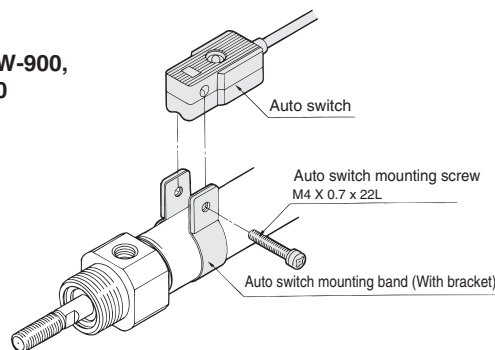

## Tie-rod Mounting Type

Applicable cylinder series: 25A-MDB, 25A-CDA2, 25A-CDS2  
 Applicable auto switches : D-M9□-900, D-M9□V-900, D-M9□W-900, D-M9□WV-900, D-M9BWSVSDPC-900, D-M9BWSVSDPC-900  
 : D-A90-900

### Auto Switch Mounting Bracket Part Nos.

Cylinder series	Applicable bore size [mm]									
	32	40	50	63	80	100	125	140	160	
25A-MDB	90- BMB5-032	90- BMB5-032	90- BA7-040	90- BA7-040	90- BA7-063	90- BA7-063	—	—	—	
25A-CDA2	—	90- BA7-040	90- BA7-040	90- BA7-063	90- BA7-080	90- BA7-080	—	—	—	
25A-CDS2	—	—	—	—	—	—	25A- BS6-125	25A- BS6-125	25A- BS6-160	

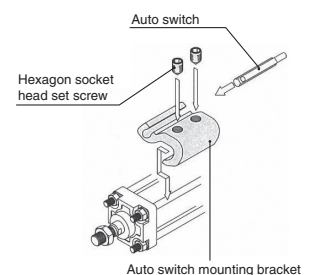



# 25A- Series

## Rail Mounting Type

Applicable cylinder series: 25A-CDBQ2

Applicable auto switches : D-M9N(V)-900, D-M9P(V)-900, D-M9B(V)-900, D-M9NW(V)-900, D-M9PW(V)-900, D-M9BW(V)-900, D-M9NA(V)-900, D-M9PA(V)-900, D-M9BA(V)-900, D-A90-900

### Auto Switch Mounting Bracket Part No.

Cylinder series	Applicable bore size [mm]							
	20	25	32	40	50	63	80	100
25A-CDBQ2	—	—	25A-BQ2-032			—	—	—

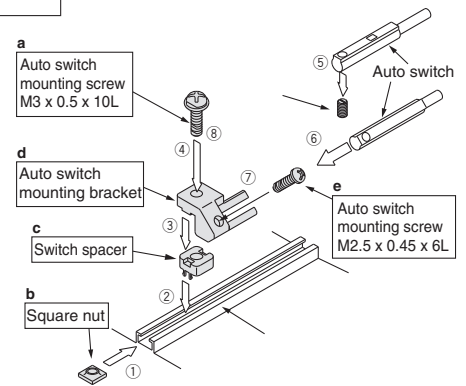

Applicable auto switches: D-F79-900, D-F7P-900, D-J79-900, D-F7NV-900, D-F7PV-900, D-F7BV-900, D-F79W-900, D-F7PW-900, D-J79W-900, D-F7NWV-900, D-F7BWV-900

### Auto Switch Mounting Bracket Part No.

Cylinder series	Applicable bore size [mm]								
	20	25	32	40	50	63	80	100	
25A-CDBQ2	—	—	25A-BQ-2						—

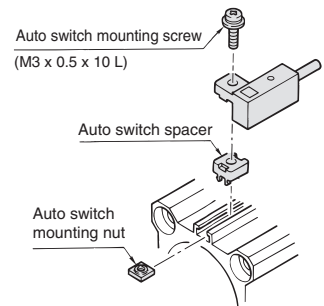

## Direct Mounting Type

Applicable cylinder series : 25A-MY1B, 25A-MY1H, 25A-MY3□,  
25A-CY3R, 25A-MGP-Z, 25A-MGP-AZ,  
25A-MGP-H/R, 25A-RSH

Applicable air gripper series: 25A-MHZ(L) 2, 25A-MHL2, 25A-MHS3, MHS4

Applicable auto switches : D-M9□-900, D-M9□V-900, D-M9□W-900,  
D-M9□WV-900, D-M9BWSRPC-900,  
D-M9BWVSDPC-900  
: D-A90L-900

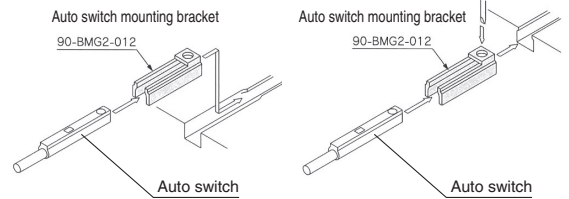

### Auto Switch Mounting Bracket Part Nos.

Cylinder series Air gripper series	Applicable bore size [mm]													
	4	6	10	12	15	16	20	25	32	40	50	63	80	100
25A-CDJP2	—	—	—	—	—	—	—	—	—	—	—	—	—	—
25A-MY1B-Z	—	—	—	—	—	—	—	—	—	—	—	—	—	—
25A-MY1H-Z	—	—	—	—	—	—	—	—	—	—	—	—	—	—
25A-MY1B	—	—	—	—	—	Not required	Not required	—	—	—	—	—	90-BMG2-012	—
25A-MY1M	—	—	—	—	—	Not required	Not required	90-BMG2-012	90-BMG2-012	90-BMG2-012	90-BMG2-012	90-BMG2-012	—	—
25A-MY1C	—	—	—	—	—	Not required	Not required	90-BMG2-012	90-BMG2-012	90-BMG2-012	90-BMG2-012	90-BMG2-012	—	—
25A-MY1H	—	—	—	—	—	Not required	Not required	—	—	—	—	—	—	—
25A-MY3□	—	—	—	—	—	—	—	—	—	—	—	—	—	—
25A-CY3R	—	—	—	—	Not required	—	Not required	90-BMG2-012	90-BMG2-012	90-BMG2-012	90-BMG2-012	90-BMG2-012	—	—
25A-MGJ	—	—	—	—	—	—	—	—	—	—	—	—	—	—
25A-MGP-Z 25A-MGP-AZ	—	—	—	Not required	—	Not required	Not required	Not required	Not required	Not required	Not required	Not required	Not required	Not required
25A-MGP-H/R	—	—	—	—	—	—	—	—	—	—	—	—	—	—
25A-RSH	—	—	—	—	—	—	—	—	—	—	—	—	—	—
25A-MHZ2	—	—	90-BMG2-012	—	—	*1	*1	*1	*1	*1	—	—	—	—
25A-MHZL2	—	—	90-BMG2-012	—	—	*1	*1	*1	—	—	—	—	—	—
25A-MHL2	—	—	90-BMG2-012	—	—	90-BMG2-012	90-BMG2-012	90-BMG2-012	90-BMG2-012	90-BMG2-012	—	—	—	—
25A-MHS3 25A-MHS4	—	—	—	—	—	Not required	Not required	Not required	90-BMG2-012	—	—	—	—	—

\*1 When mounting D-M9 type of auto switch onto the square groove of the side of the air gripper, the auto switch mounting bracket (90-BMG2-012) is required.



# 25A- Series Precautions

Be sure to read this before handling products.

## Precautions

### Caution

#### ■ Change of material

For the 25A- series, there is a restriction on the use of copper and zinc as main components in the metal materials used. Keep in mind that the aluminium alloy, aluminium die cast, and some of the stainless steel materials contain traces of copper (Cu) and/or zinc (Zn) as an additive element.

However, copper is used in some parts—the coils of solenoid valves, the circuit boards, connector pins, and lead wires of electrical equipment and auto switches, and the motors, cables, and drivers of electric actuators—whose materials cannot be easily changed to alternative materials.

In addition, some magnets (including the surface treatment) contain copper (Cu) and/or zinc (Zn). However, due to their magnetic characteristics, it is impossible to use alternative materials.

#### ■ Particle generation (metallic contaminants)

Usage of metal stoppers and/or shock absorbers on an air slide table produces metal-to-metal collision and contact, and may generate wear particles. Do not use metal stoppers and/or shock absorbers in an environment where wear particles are problem.

When the buffer mechanism or the end lock mechanism functional options are used, dust particles may be generated by the buffer part as well as the end lock part.

The following models of air gripper may generate dust particles, as metal-to-metal collisions occur when fingers are fully closed.

- MHZ2
- MHZL2 (Except -X5955)
- MHF2
- MHY2

#### ■ Static electricity

Refrain from using the electrical equipments including detection switches (e.g., pressure switches and flow switches) in electrostatically-charged environments. Otherwise, they may cause the system to fail or to malfunction.

#### ■ Piping

Usage of nylon tubing and polyurethane tubing in environments with a low dew point may affect dew points of ambient air and inside of piping. Use fluoropolymer tubing (TL series) or stainless steel tubing (Supply it on your own) in environments with a low dew point.

#### ■ Chemical environment

Refrain from using the products in such environments as exposed to chemicals. Otherwise, resin parts may deteriorate.

If you want SMC to test the products for the effects of chemicals attached to them, send the products back to SMC after thoroughly cleaning them.

Consult your SMC sales representative for further details.

#### ■ Trademark

DeviceNet™ is a trademark of ODVA.

EtherNet/IP™ is a trademark of ODVA.

EtherCAT® is registered trademark and patented technology, licensed by Beckhoff Automation GmbH, Germany.

Be sure to read the "Handling Precautions for SMC Products" (M-E03-3) and the "Operation Manual" before use.

## Safety Instructions

These safety instructions are intended to prevent hazardous situations and/or equipment damage. These instructions indicate the level of potential hazard with the labels of “Caution,” “Warning” or “Danger.” They are all important notes for safety and must be followed in addition to International Standards (ISO/IEC)<sup>1)</sup>, and other safety regulations.

### Caution:

**Caution** indicates a hazard with a low level of risk which, if not avoided, could result in minor or moderate injury.

### Warning:

**Warning** indicates a hazard with a medium level of risk which, if not avoided, could result in death or serious injury.

### Danger:

**Danger** indicates a hazard with a high level of risk which, if not avoided, will result in death or serious injury.

- 1) ISO 4414: Pneumatic fluid power – General rules relating to systems.  
ISO 4413: Hydraulic fluid power – General rules relating to systems.  
IEC 60204-1: Safety of machinery – Electrical equipment of machines.  
(Part 1: General requirements)  
ISO 10218-1: Manipulating industrial robots - Safety.  
etc.

## Warning

### 1. The compatibility of the product is the responsibility of the person who designs the equipment or decides its specifications.

Since the product specified here is used under various operating conditions, its compatibility with specific equipment must be decided by the person who designs the equipment or decides its specifications based on necessary analysis and test results. The expected performance and safety assurance of the equipment will be the responsibility of the person who has determined its compatibility with the product. This person should also continuously review all specifications of the product referring to its latest catalogue information, with a view to giving due consideration to any possibility of equipment failure when configuring the equipment.

### 2. Only personnel with appropriate training should operate machinery and equipment.

The product specified here may become unsafe if handled incorrectly. The assembly, operation and maintenance of machines or equipment including our products must be performed by an operator who is appropriately trained and experienced.

### 3. Do not service or attempt to remove product and machinery/equipment until safety is confirmed.

1. The inspection and maintenance of machinery/equipment should only be performed after measures to prevent falling or runaway of the driven objects have been confirmed.
2. When the product is to be removed, confirm that the safety measures as mentioned above are implemented and the power from any appropriate source is cut, and read and understand the specific product precautions of all relevant products carefully.
3. Before machinery/equipment is restarted, take measures to prevent unexpected operation and malfunction.

### 4. Contact SMC beforehand and take special consideration of safety measures if the product is to be used in any of the following conditions.

1. Conditions and environments outside of the given specifications, or use outdoors or in a place exposed to direct sunlight.
2. Installation on equipment in conjunction with atomic energy, railways, air navigation, space, shipping, vehicles, military, medical treatment, combustion and recreation, or equipment in contact with food and beverages, emergency stop circuits, clutch and brake circuits in press applications, safety equipment or other applications unsuitable for the standard specifications described in the product catalogue.
3. An application which could have negative effects on people, property, or animals requiring special safety analysis.
4. Use in an interlock circuit, which requires the provision of double interlock for possible failure by using a mechanical protective function, and periodical checks to confirm proper operation.

## Caution

### 1. The product is provided for use in manufacturing industries.

The product herein described is basically provided for peaceful use in manufacturing industries.  
If considering using the product in other industries, consult SMC beforehand and exchange specifications or a contract if necessary.  
If anything is unclear, contact your nearest sales branch.

## Limited warranty and Disclaimer/Compliance Requirements

The product used is subject to the following “Limited warranty and Disclaimer” and “Compliance Requirements”. Read and accept them before using the product.

### Limited warranty and Disclaimer

1. The warranty period of the product is 1 year in service or 1.5 years after the product is delivered, whichever is first.<sup>2)</sup> Also, the product may have specified durability, running distance or replacement parts. Please consult your nearest sales branch.
  2. For any failure or damage reported within the warranty period which is clearly our responsibility, a replacement product or necessary parts will be provided. This limited warranty applies only to our product independently, and not to any other damage incurred due to the failure of the product.
  3. Prior to using SMC products, please read and understand the warranty terms and disclaimers noted in the specified catalogue for the particular products.
- 2) Vacuum pads are excluded from this 1 year warranty.  
A vacuum pad is a consumable part, so it is warranted for a year after it is delivered. Also, even within the warranty period, the wear of a product due to the use of the vacuum pad or failure due to the deterioration of rubber material are not covered by the limited warranty.

### Compliance Requirements

1. The use of SMC products with production equipment for the manufacture of weapons of mass destruction (WMD) or any other weapon is strictly prohibited.
2. The exports of SMC products or technology from one country to another are governed by the relevant security laws and regulations of the countries involved in the transaction. Prior to the shipment of a SMC product to another country, assure that all local rules governing that export are known and followed.

## Caution

### SMC products are not intended for use as instruments for legal metrology.

Measurement instruments that SMC manufactures or sells have not been qualified by type approval tests relevant to the metrology (measurement) laws of each country.  
Therefore, SMC products cannot be used for business or certification ordained by the metrology (measurement) laws of each country.

## Safety Instructions

Be sure to read “Handling Precautions for SMC Products” (M-E03-3) before using.

## SMC Corporation (Europe)

<b>Austria</b>	+43 (0)2262622800	www.smc.at	office@smc.at
<b>Belgium</b>	+32 (0)33551464	www.smc.be	info@smc.be
<b>Bulgaria</b>	+359 (0)2807670	www.smc.bg	office@smc.bg
<b>Croatia</b>	+385 (0)13707288	www.smc.hr	office@smc.hr
<b>Czech Republic</b>	+420 541424611	www.smc.cz	office@smc.cz
<b>Denmark</b>	+45 70252900	www.smc.dk.com	smc@smcdk.com
<b>Estonia</b>	+372 651 0370	www.smcee.ee	info@smcee.ee
<b>Finland</b>	+358 207513513	www.smc.fi	smcfi@smc.fi
<b>France</b>	+33 (0)164761000	www.smc-france.fr	supportclient@smc-france.fr
<b>Germany</b>	+49 (0)61034020	www.smc.de	info@smc.de
<b>Greece</b>	+30 210 2717265	www.smchellas.gr	sales@smchellas.gr
<b>Hungary</b>	+36 23513000	www.smc.hu	office@smc.hu
<b>Ireland</b>	+353 (0)14039000	www.smcautomation.ie	sales@smcautomation.ie
<b>Italy</b>	+39 03990691	www.smcitalia.it	mailbox@smcitalia.it
<b>Latvia</b>	+371 67817700	www.smc.lv	info@smc.lv

<b>Lithuania</b>	+370 5 2308118	www.smclt.lt	info@smclt.lt
<b>Netherlands</b>	+31 (0)205318888	www.smc.nl	info@smc.nl
<b>Norway</b>	+47 67129020	www.smc-norge.no	post@smc-norge.no
<b>Poland</b>	+48 222119600	www.smc.pl	office@smc.pl
<b>Portugal</b>	+351 214724500	www.smc.eu	apoioclientept@smc.smces.es
<b>Romania</b>	+40 213205111	www.smcromania.ro	smcromania@smcromania.ro
<b>Russia</b>	+7 (812)3036600	www.smc.eu	sales@smcru.com
<b>Slovakia</b>	+421 (0)413213212	www.smc.sk	office@smc.sk
<b>Slovenia</b>	+386 (0)73885412	www.smc.si	office@smc.si
<b>Spain</b>	+34 945184100	www.smc.eu	post@smc.smces.es
<b>Sweden</b>	+46 (0)86031240	www.smc.nu	smc@smc.nu
<b>Switzerland</b>	+41 (0)523963131	www.smc.ch	info@smc.ch
<b>Turkey</b>	+90 212 489 0 440	www.smcturkey.com.tr	satis@smcturkey.com.tr
<b>UK</b>	+44 (0)845 121 5122	www.smc.uk	sales@smc.uk

**South Africa** +27 10 900 1233    www.smcza.co.za    zasales@smcza.co.za