

Metal One-touch Fittings

Compact and Light

New

RoHS

Dimensions **Approx. 30%**
* Comparison with KQBL06-01S

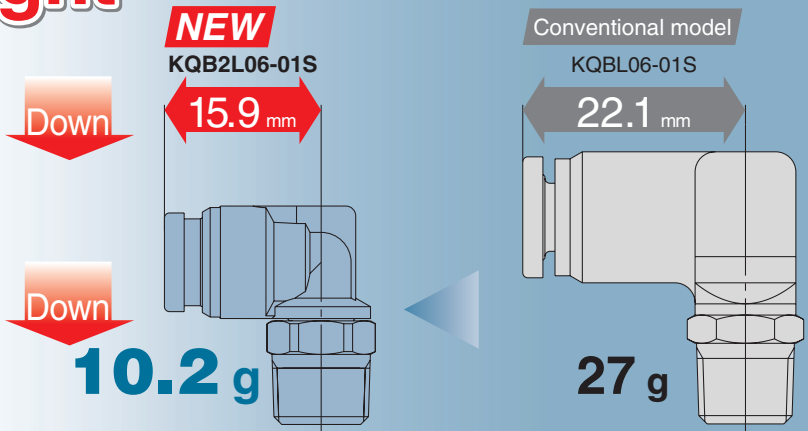

Weight **Approx. 62%**
* Comparison with KQBL06-01S

- More configuration variations
17 models < **9** models

Fluid temperature **-5 to 150°C**

Connection thread M, R, Rc, UNF, NPT, G

Applicable tube material FEP • PFA • Nylon • Soft nylon
Polyurethane • Polyolefin

- Electroless nickel plated (Brass parts)
- Grease-free

Variations

● Added size

Connection thread	Applicable tube O.D. (mm)						
	ø3.2	ø4	ø6	ø8	ø10	ø12	ø16
M5	●	●	●	●	●	●	●
R1/8	●	●	●	●	●	●	●
G1/8	●	●	●	●	●	●	●
R1/4	●	●	●	●	●	●	●
G1/4	●	●	●	●	●	●	●
R3/8	●	●	●	●	●	●	●
G3/8	●	●	●	●	●	●	●
R1/2	●	●	●	●	●	●	●
G1/2	●	●	●	●	●	●	●
No thread	●	●	●	●	●	●	●

Connection thread	Applicable tube O.D. (inch)					
	ø1/8"	ø5/32"	ø1/4"	ø5/16"	ø3/8"	ø1/2"
10-32 UNF	●	●	●	●	●	●
NPT1/8	●	●	●	●	●	●
NPT1/4	●	●	●	●	●	●
NPT3/8	●	●	●	●	●	●
NPT1/2	●	●	●	●	●	●
No thread	●	●	●	●	●	●

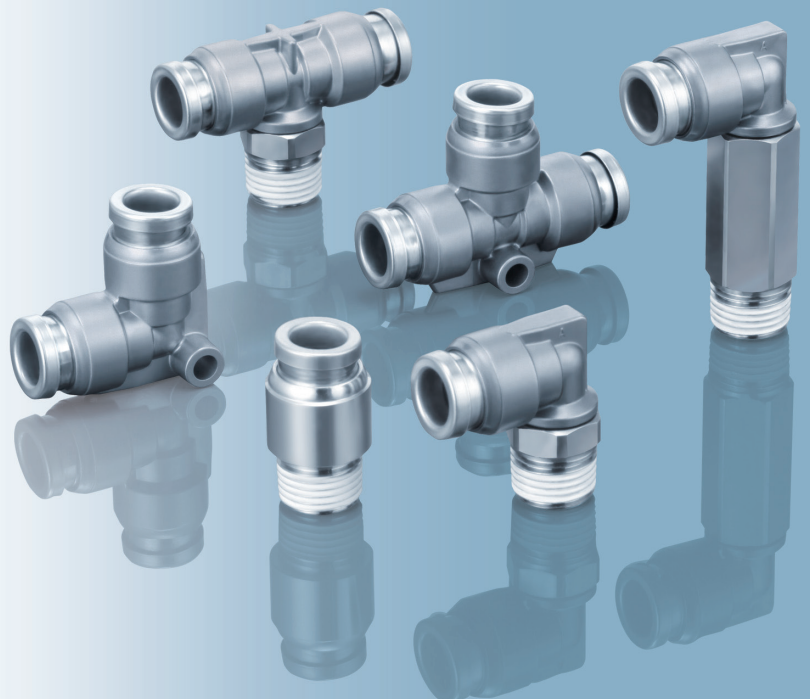

Series **KQB2**



CAT.EUS50-34A-UK

Compact and light

Dimensions: Approx. **30%** down
* Comparison with KQBL06-01S

Weight: Approx. **62%** down
* Comparison with KQBL06-01S

More tube sizes added

Ø3.2 (Ø1.8") and Ø16 have been added.

More configuration variations

17 models < **9** models

Inch size x UNF/NPT thread, Metric size x G thread added

Applicable tube size

Ø3.2 to Ø16, Ø1/8" to Ø1/2"

Connection thread: M, R, Rc, UNF, NPT, G

Fluid temperature: -5 to 150°C

Grease-free

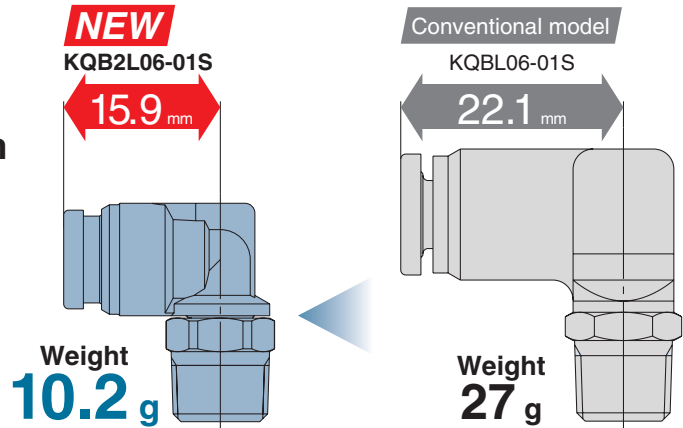

Applicable tube material

FEP • PFA • Nylon • Soft nylon
Polyurethane • Polyolefin

Electroless nickel plated (Brass parts)

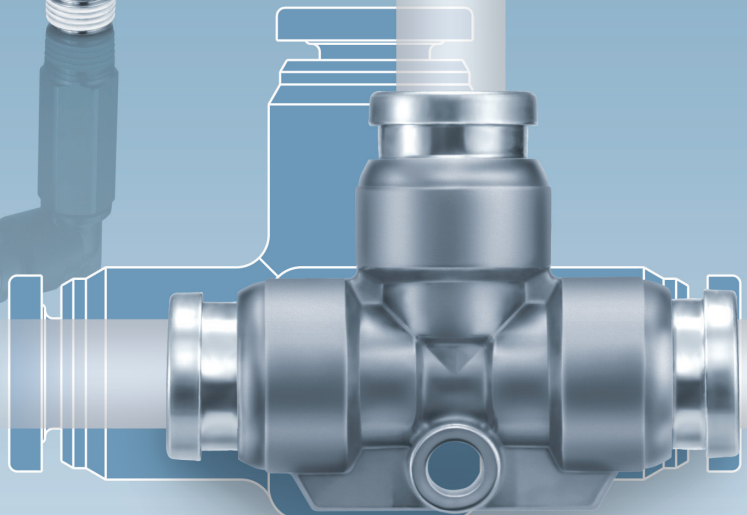
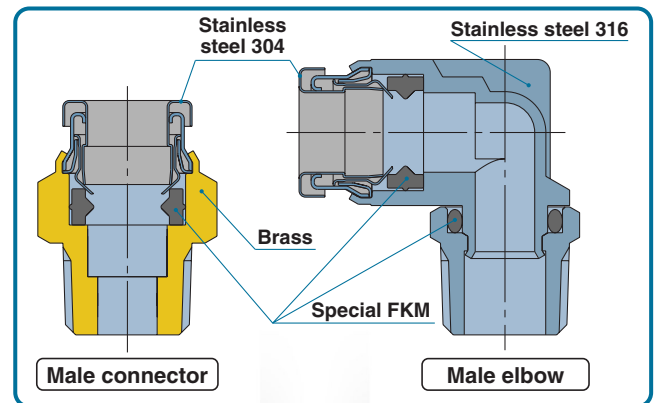

Variations

Male Connector **KQB2H**



Metric
R thread P. 3
G thread P. 16
Inch P. 10

Bulkhead Union **KQB2E**



Metric P. 5
Inch P. 12

Different Diameter Union "Y" **KQB2U**



Metric P. 6
Inch P. 13

Hexagon Socket Head Male Connector **KQB2S**



Metric
R thread P. 3
G thread P. 16
Inch P. 10

Union Tee **KQB2T**



Metric P. 5
Inch P. 12

Bulkhead Connector **KQB2E**

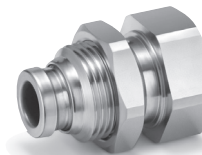

Metric
Rc thread P. 7
G thread P. 18
Inch P. 13

Straight Union **KQB2H**



Metric P. 3
Inch P. 10

Union "Y" **KQB2U**



Metric P. 5
Inch P. 12

Extended Male Elbow **KQB2W**



Metric
R thread P. 7
G thread P. 18
Inch P. 13

Male Elbow **KQB2L**



Metric
R thread P. 4
G thread P. 17
Inch P. 11

Different Diameter Tee **KQB2T**



Metric P. 6
Inch P. 12

Female Connector **KQB2F**

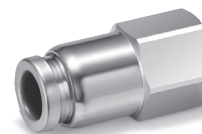

Metric
Rc thread P. 8
G thread P. 18
Inch P. 14

Male Branch Tee **KQB2T**



Metric
R thread P. 4
G thread P. 17
Inch P. 11

Plug-in Reducer **KQB2R**



Metric P. 6
Inch P. 12

Plug **KQB2P**



Metric P. 8
Inch P. 14

Union Elbow **KQB2L**



Metric P. 5
Inch P. 11

Different Diameter Straight **KQB2H**



Metric P. 6
Inch P. 13

Metal One-touch Fittings

Applicable Tube: Metric Size, Connection Thread: M, R, Rc

Series **KQB2**

RoHS



Applicable Tube

Tube material	FEP, PFA, Nylon, Soft nylon, Polyurethane, Polyolefin
Tube O.D.	ø3.2, ø4, ø6, ø8, ø10, ø12, ø16

Specifications

Fluid	Air, N ₂ , Water ^{Note 2)}
Operating pressure range ^{Note 1)}	-100 kPa to 1 MPa ^{Note 3)}
Proof pressure	3.0 MPa
Ambient and fluid temperature ^{Note 4)}	-5 to 150°C (No freezing) ^{Note 3)}
Lubricant	Grease-free specification
Seal on the threads	With sealant

- Note 1) Avoid using in a vacuum holding application such as a leak tester, since there is leakage.
 Note 2) Deionized water is not recommended for use as it may affect the material used in the fittings. In addition, it is known to degrade the water quality.
 Note 3) Check the operating pressure range and operating temperature range of the tubing.
 Note 4) It is recommended that you use the inner sleeve in the following conditions (Except ø3.2):
- When using in an environment where the fluid temperature changes drastically.
 - When using at a high temperature.

* Temperature Condition of Mounting the Inner Sleeve

Tube	Temperature
FEP tube/TH series	80C or more
PFA tube/TL series	120C or more

Spare Parts

Description	Tube O.D.	Part no.	Material
Gasket	—	M-5G3	Stainless steel 316, Special FKM
Bulkhead nut	ø3.2	KQB223-P01	C3604 (Electroless nickel plated)
	ø4		
	ø6	KQB206-P01	
	ø8	KQB208-P01	
	ø10	KQB210-P01	
	ø12	KQB212-P01	
	ø16	KQB216-P01	

Cross Reference Table of the Inner Sleeve

Tube O.D.	Tube material			Applicable inner sleeve	
	TUS (Soft polyurethane)	TH/THI (FEP)	TL/TIL (PFA)	Part no.	Length
ø4	—	TH0402	—	TJ-0402	18
	TUS0425	TH0425	—	TJ-0425	18
	—	—	TL0403	TJ-0403	18
ø6	TUS0604	TH0604	TL0604	TJ-0604	19
	TUS0805	—	—	TJ-0805	20.5
ø8	—	TH0806	TL0806	TJ-0806	20.5
	TUS1065	—	—	TJ-1065	23
ø10	—	TH1075	—	TJ-1075	23
	—	TH1008	TL1008	TJ-1008	23
	TUS1208	—	—	TJ-1208	24
ø12	—	TH1209	—	TJ-1209	24
	—	TH1210	TL1210	TJ-1210	24
	—	—	—	—	—

* C2700 + Electroless nickel plated is used for the TJ series.

Construction

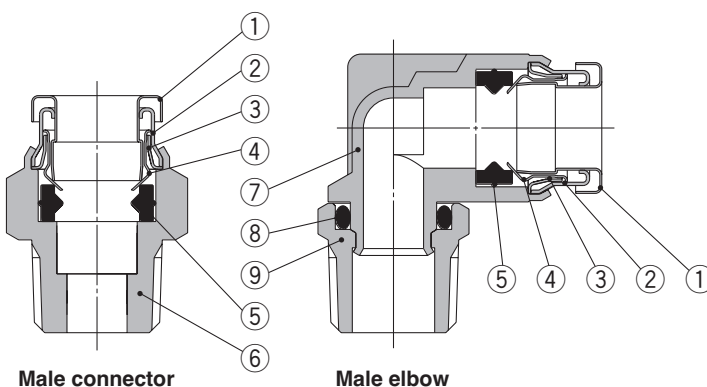

Component Parts

No.	Description	Material
1	Release button	Stainless steel 304
2	Guide 1	Stainless steel 304
3	Guide 2	Stainless steel 304
4	Chuck	Stainless steel 304
5	Seal	Special FKM (Fluoro coated)
6	Male connector body	C3604 (Electroless nickel plated)
7	Male elbow body	Stainless steel 316
8	O-ring	Special FKM (Fluoro coated)
9	Stud	C3604 (Electroless nickel plated)

Metal One-touch Fittings **KQB2 Series**

Applicable Tubing: Metric Size, Connection Thread: M, R, Rc

Dimensions

Male Connector: KQB2H



Applicable tubing O.D. (mm)	Connection thread R, M	Model	H (Width across flat)	øD	L	A*	M	Note) Effective area (mm ²)	Weight (g)
ø3.2	M5 x 0.8	KQB2H23-M5	8	—	16.5	13.5	12	3	3.4
	1/8	KQB2H23-01S	10		15.4	12.3			
	1/4	KQB2H23-02S	14		21	16.3			
ø4	M5 x 0.8	KQB2H04-M5	10	—	17.1	14.1	12.6	4	5.3
	1/8	KQB2H04-01S	10		15.3	12.2			
	1/4	KQB2H04-02S	14		20.9	16.2			
ø6	M5 x 0.8	KQB2H06-M5	12	—	19.1	16.1	13.6	4	8
	1/8	KQB2H06-01S	12		18.1	15			
	1/4	KQB2H06-02S	14		20.8	16.1			
	3/8	KQB2H06-03S	17		23	17.9			
ø8	1/8	KQB2H08-01S	14	—	24.5	21.4	16.1	26.1	13.5
	1/4	KQB2H08-02S	14		22.3	17.6			
	3/8	KQB2H08-03S	17		23.7	18.6			
ø10	1/8	KQB2H10-01S	17	—	25.5	22.4	17	26.1	19.8
	1/4	KQB2H10-02S	17		27.9	23.2			
	3/8	KQB2H10-03S	17		23	17.9			
ø12	1/2	KQB2H10-04S	22	—	28.6	22.2	18.6	58.3	21.5
	1/4	KQB2H12-02S	19		30.5	25.8			
	3/8	KQB2H12-03S	19		24.7	19.6			
ø16	1/2	KQB2H12-04S	22	24.6	28.7	22.3	20.8	81	48.3
	3/8	KQB2H16-03S	24		33.6	28.5			
	1/2	KQB2H16-04S	24		29.5	23.1			

* Reference dimensions after installation for R thread

Note) Value of FEP tubing.

Value of nylon tubing for ø16 only.

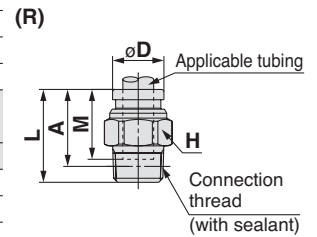
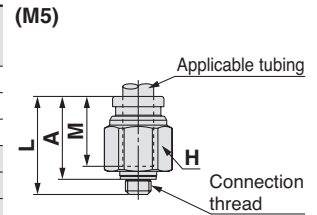

Hexagon Socket Head Male Connector: KQB2S



Applicable tubing O.D. (mm)	Connection thread R, M	Model	H (Width across flat)	Note 1) øD	L	A*	M	Note 2) Effective area (mm ²)	Weight (g)	
ø3.2	M5 x 0.8	KQB2S23-M5	2	9	16.5	13.5	12	3	4	
ø4	M5 x 0.8	KQB2S04-M5	2	9	17.1	14.1	12.6	4	3.9	
	1/8	KQB2S04-01S	3	10	20.4	17.3				
ø6	M5 x 0.8	KQB2S06-M5	2	12	19.6	16.6	13.6	4	7.8	
	1/8	KQB2S06-01S	4		20.6	17.5				
	1/4	KQB2S06-02S	4		14	15.9				10.7
ø8	1/8	KQB2S08-01S	5	14	24.7	21.6	16.1	23.3	13	
	1/4	KQB2S08-02S	6		22.9	18.2				
	3/8	KQB2S08-03S	6		17	23.1				18
ø10	1/8	KQB2S10-01S	5	17	25.6	22.5	17	39	18.6	
	1/4	KQB2S10-02S	8		27.5	22.8				
	3/8	KQB2S10-03S	8		17	18.9				20
	1/2	KQB2S10-04S	8		22	17.6				39.2
ø12	1/4	KQB2S12-02S	8	19	30.6	25.9	18.6	46	26	
	3/8	KQB2S12-03S	10		24.9	19.8				
	1/2	KQB2S12-04S	10		22	18.5				60
ø16	3/8	KQB2S16-03S	10	24.6	33.2	28.1	20.8	81	43.6	
	1/2	KQB2S16-04S	12		29.4	23				

* Reference dimensions after installation for R thread

Note 1) For the ø16, this dimension refers to the O.D. of the release button.

Note 2) Value of FEP tubing.

Value of nylon tubing for ø16 only.

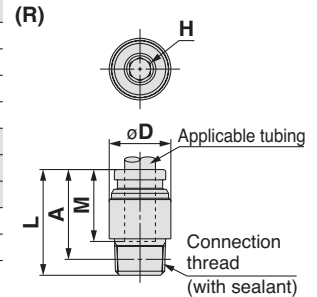
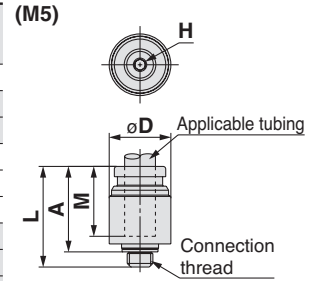

Straight Union: KQB2H



Applicable tubing O.D. (mm)	Model	øD Note 1)	L	M	Note 2) Effective area (mm ²)	Weight (g)
ø3.2	KQB2H23-00	9	25	12	3.4	6.8
ø4	KQB2H04-00	9	26.2	12.6	5.6	6.8
ø6	KQB2H06-00	12	28.2	13.6	13.1	12
ø8	KQB2H08-00	14	33.2	16.1	26.1	17.4
ø10	KQB2H10-00	17	35	17	41.5	27.2
ø12	KQB2H12-00	19	38.2	18.6	58.3	33.7
ø16	KQB2H16-00	24.6	42.6	20.8	113	56.1

Note 1) For the ø16, this dimension refers to the O.D. of the release button.

Note 2) Value of FEP tubing.

Value of nylon tubing for ø16 only.

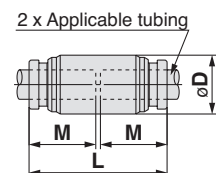

KQB2 Series

Applicable Tubing: Metric Size, Connection Thread: M, R, Rc

Dimensions

Male Elbow: KQB2L



Applicable tubing O.D. (mm)	Connection thread R, M	Model	H (Width across flat)	Note 1) ϕD	L1	L2	A*	M	Note 2) Effective area (mm ²)	Weight (g)
$\phi 3.2$	M5 x 0.8	KQB2L23-M5	8	8.3	13.1	14.8	16	12	2.6	6.5
	1/8	KQB2L23-01S	10		13.6	14.9	15.9		3	8
	1/4	KQB2L23-02S	14		18.7	18.1	16.6			
$\phi 4$	M5 x 0.8	KQB2L04-M5	8	9.1	13.7	15.2	16.8	12.6	3.5	7
	1/8	KQB2L04-01S	10		14.4	15.3	16.7		4.2	8.6
	1/4	KQB2L04-02S	14		19.1	18.9	17.5			
$\phi 6$	M5 x 0.8	KQB2L06-M5	8	11.4	14.7	16.3	19	13.6	3.5	9
	1/8	KQB2L06-01S	10		15.9	16.4	21.2		11.4	10.2
	1/4	KQB2L06-02S	14		20.2	21.6	22.2		19.1	
	3/8	KQB2L06-03S	17		21.6	22.2	31.2			
$\phi 8$	1/8	KQB2L08-01S	12	13.7	18.6	18.3	22	16.1	21.6	14.8
	1/4	KQB2L08-02S	14		19.1	21.5	23.6		20.8	
	3/8	KQB2L08-03S	17		22.9	24.6	32.8			
$\phi 10$	1/8	KQB2L10-01S	12	16.6	20	19.7	24.9	17	21.6	20.4
	1/4	KQB2L10-02S	14		21	22.9	26.5		23.7	
	3/8	KQB2L10-03S	17		24.3	27.5	35.2		34.5	
	1/2	KQB2L10-04S	22		28.5	30.4	62.6			
$\phi 12$	1/4	KQB2L12-02S	14	18.7	22.6	24	28.6	18.6	50.2	27.4
	3/8	KQB2L12-03S	17		23.6	25.3	29.5		34.3	
	1/2	KQB2L12-04S	22		29.5	32.4	60.8			
$\phi 16$	3/8	KQB2L16-03S	19	24.6	26.3	28	34.5	20.8	71	47
	1/2	KQB2L16-04S	22		27.3	31.8	37		100	62.6

* Reference dimensions after installation for R thread

Note 1) For the $\phi 16$, this dimension refers to the O.D. of the release button.

Note 2) Value of FEP tubing.

Value of nylon tubing for $\phi 16$ only.

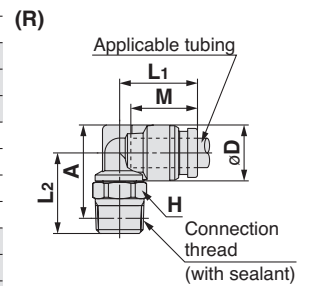
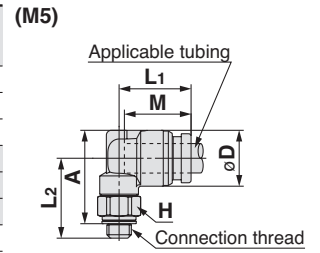

Male Branch Tee: KQB2T



Applicable tubing O.D. (mm)	Connection thread R, M	Model	H (Width across flat)	Note 1) ϕD	L1	L2	A*	M	Note 2) Effective area (mm ²)	Weight (g)
$\phi 3.2$	M5 x 0.8	KQB2T23-M5	8	8.3	13.1	14.8	16	12	3.2	8.2
	1/8	KQB2T23-01S	10		13.6	14.9	15.9		3.4	9.6
	1/4	KQB2T23-02S	14		18.7	18.1	18.4			
$\phi 4$	M5 x 0.8	KQB2T04-M5	8	9.1	13.7	15.2	16.8	12.6	4.5	9.1
	1/8	KQB2T04-01S	10		14.4	15.3	16.7		6	10.6
	1/4	KQB2T04-02S	14		19.1	18.9	19.4			
$\phi 6$	M5 x 0.8	KQB2T06-M5	8	11.4	14.7	16.3	19	13.6	4.5	12.1
	1/8	KQB2T06-01S	10		15.9	16.4	21.2		13.9	13.6
	1/4	KQB2T06-02S	14		20.2	21.6	22.2		22.5	
	3/8	KQB2T06-03S	17		21.6	22.2	35			
$\phi 8$	1/8	KQB2T08-01S	12	13.7	18.6	18.3	22	16.1	26.3	20
	1/4	KQB2T08-02S	14		19.1	21.5	23.6		26.1	
	3/8	KQB2T08-03S	17		22.9	24.6	38			
$\phi 10$	1/8	KQB2T10-01S	12	16.6	20	19.7	24.9	17	40.8	28.6
	1/4	KQB2T10-02S	14		21	22.9	26.5		31.5	
	3/8	KQB2T10-03S	17		24.3	27.5	42.4			
	1/2	KQB2T10-04S	22		28.5	30.4	70.4			
$\phi 12$	1/4	KQB2T12-02S	14	18.7	22.6	24	28.6	18.6	57.2	38.1
	3/8	KQB2T12-03S	17		23.6	25.3	29.5		39.7	
	1/2	KQB2T12-04S	22		29.5	32.4	70.8			
$\phi 16$	3/8	KQB2T16-03S	19	24.6	26.3	28	34.5	20.8	71	64.4
	1/2	KQB2T16-04S	22		27.3	31.8	37		100	79

* Reference dimensions after installation for R thread

Note 1) For the $\phi 16$, this dimension refers to the O.D. of the release button.

Note 2) Value of FEP tubing.

Value of nylon tubing for $\phi 16$ only.

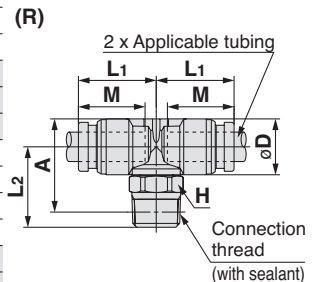
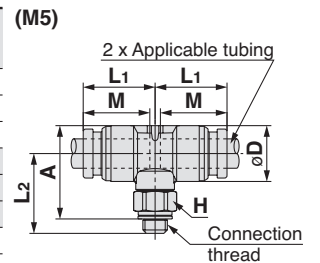

Metal One-touch Fittings **KQB2 Series**

Applicable Tubing: Metric Size, Connection Thread: M, R, Rc

Dimensions

Union Elbow: KQB2L



Applicable tubing O.D. (mm)	Model	Note 1) ϕD	L	A	Q	M	ϕN	ϕO	Note 2) Effective area (mm ²)	Weight (g)
$\phi 3.2$	KQB2L23-00	8.3	13.6	19.3	2.9	12	3.2	5.6	3	6.3
$\phi 4$	KQB2L04-00	9.1	14.6	20.5	3.1	12.6	3.2	5.6	4.2	7.4
$\phi 6$	KQB2L06-00	11.4	16.6	23	3.6	13.6	3.2	5.6	11.4	11
$\phi 8$	KQB2L08-00	13.7	20.1	29.1	5	16.1	4.2	8	21.6	20.2
$\phi 10$	KQB2L10-00	16.6	22	31.7	5.7	17	4.2	8	35.2	29.6
$\phi 12$	KQB2L12-00	18.7	24.6	35	6.4	18.6	4.2	8	50.2	37.1
$\phi 16$	KQB2L16-00	24.6	28.8	40.5	7.7	20.8	4.2	8	100	59.7

Note 1) For the $\phi 16$, this dimension refers to the O.D. of the release button.

Note 2) Value of FEP tubing.

Value of nylon tubing for $\phi 16$ only.

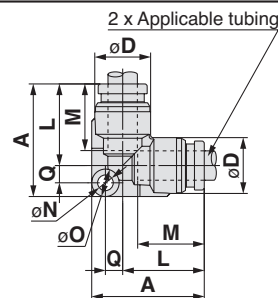

Bulkhead Union: KQB2E



Applicable tubing O.D. (mm)	Model	T (M)	H (Width across flat)	L	Mounting hole	M	Note) Effective area (mm ²)	Weight (g)
$\phi 3.2$	KQB2E23-00	M10 x 1	12	32.2	11	12	3.4	14.8
$\phi 4$	KQB2E04-00	M10 x 1	12	32.4	11	12.6	5.6	14.7
$\phi 6$	KQB2E06-00	M14 x 1	17	35.4	15	13.6	13.1	29.2
$\phi 8$	KQB2E08-00	M15 x 1	19	38.8	16	16.1	26.1	34.9
$\phi 10$	KQB2E10-00	M18 x 1	21	40	19	17	41.5	47.1
$\phi 12$	KQB2E12-00	M20 x 1	24	42.4	21	18.6	58.3	58.7
$\phi 16$	KQB2E16-00	M27 x 1	30	46.8	28	20.8	113	107.2

Note) Value of FEP tubing.

Value of nylon tubing for $\phi 16$ only.

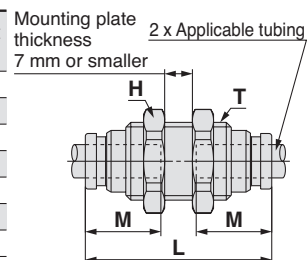

Union Tee: KQB2T



Applicable tubing O.D. (mm)	Model	Note 1) ϕD	L	A	Q	M	ϕN	ϕO	Note 2) Effective area (mm ²)	Weight (g)
$\phi 3.2$	KQB2T23-00	8.3	13.6	20.5	4.1	12	3.2	5.6	3.4	7.9
$\phi 4$	KQB2T04-00	9.1	14.6	21.8	4.4	12.6	3.2	5.6	6.4	9.5
$\phi 6$	KQB2T06-00	11.4	16.6	24.6	5.2	13.6	3.2	5.6	13.4	14.2
$\phi 8$	KQB2T08-00	13.7	20.1	31.1	7	16.1	4.2	8	25.6	24.4
$\phi 10$	KQB2T10-00	16.6	22	34	8	17	4.2	8	40	36.8
$\phi 12$	KQB2T12-00	18.7	24.6	37.7	9.1	18.6	4.2	8	57.4	47
$\phi 16$	KQB2T16-00	24.6	28.8	43.4	10.6	20.8	4.2	8	100	75.5

Note 1) For the $\phi 16$, this dimension refers to the O.D. of the release button.

Note 2) Value of FEP tubing.

Value of nylon tubing for $\phi 16$ only.

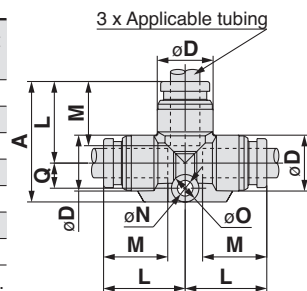

Union "Y": KQB2U



Applicable tubing O.D. (mm)	Model	Note 1) ϕD	W	L ₁	L ₂	P	M	ϕN	ϕO	Note 2) Effective area (mm ²)	Weight (g)
$\phi 3.2$	KQB2U23-00	8.3	16.4	29	11	8.1	12	3.2	5.6	3.4	9.2
$\phi 4$	KQB2U04-00	9.1	18.2	30.4	11.3	9.1	12.6	3.2	5.6	4.2	11.1
$\phi 6$	KQB2U06-00	11.4	22.9	34.9	12.2	11.5	13.6	3.2	5.6	13.4	18.8
$\phi 8$	KQB2U08-00	13.7	28.3	40.1	14.1	14.6	16.1	4.2	8	25.6	29.7
$\phi 10$	KQB2U10-00	16.6	34.2	44	14.4	17.6	17	4.2	8	40	47.4
$\phi 12$	KQB2U12-00	18.7	38.5	48.4	15.8	19.8	18.6	4.2	8	57.4	62.1
$\phi 16$	KQB2U16-00	24.6	49.3	56.6	17.3	26	20.8	4.2	8	113	110.2

Note 1) For the $\phi 16$, this dimension refers to the O.D. of the release button.

Note 2) Value of FEP tubing.

Value of nylon tubing for $\phi 16$ only.

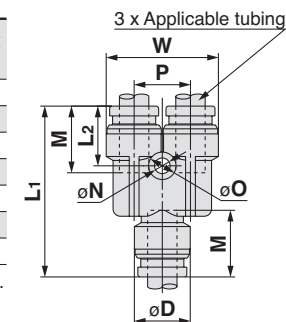

KQB2 Series

Applicable Tubing: Metric Size, Connection Thread: M, R, Rc

Dimensions

Different Diameter Tee: KQB2T



Applicable tubing O.D. (mm)		Model	Note 1)	Note 1)	L ₁	L ₂	L ₃	Q	M ₁	M ₂	øN	øO	Note 2)	Weight (g)
a	b		øD ₁	øD ₂									Effective area (mm ²)	
ø3.2	ø4	KQB2T23-04	9.1	8.3	14.2	14.1	21.1	4.1	12.6	12	3.2	5.6	3.8	8.5
ø4	ø6	KQB2T04-06	11.4	9.1	15.6	15.7	22.8	4.4	13.6	12.6	3.2	5.6	7.1	11
ø6	ø8	KQB2T06-08	13.7	11.4	19.1	17.7	29.5	6.4	16.1	13.6	4.2	8	16.4	20
ø8	ø10	KQB2T08-10	16.6	13.7	21	21.2	32.1	7.1	17	16.1	4.2	8	36	29.8
ø10	ø12	KQB2T10-12	18.7	16.6	23.6	23.1	35.7	8.1	18.6	17	4.2	8	56	41.3
ø12	ø16	KQB2T12-16	24.6	18.7	26.8	26.7	39.9	9.1	20.8	18.6	4.2	8	108.5	58

Note 1) For the ø16, this dimension refers to the O.D. of the release button.
Note 2) Value of FEP tubing.

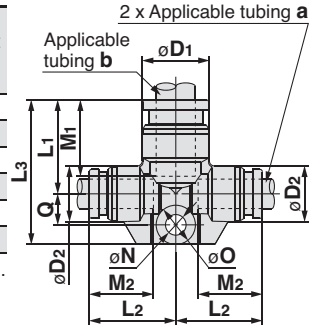

Plug-in Reducer: KQB2R



Applicable tubing O.D. (mm)	Applicable fitting size ød	Model	øD	L	A	M	Note)	Weight (g)
							Effective area (mm ²)	
ø3.2	ø4	KQB2R23-04	9	32.9	20.3	12	3.4	4.9
ø4	ø6	KQB2R04-06	9	34.4	20.8	12.6	5.6	7
ø6	ø8	KQB2R06-08	12	38.4	22.3	13.6	13.1	12.7
ø8	ø10	KQB2R08-10	14	41.9	24.9	16.1	26.1	19.2
ø10	ø12	KQB2R10-12	17	44.8	26.2	17	41.5	27.8
ø12	ø16	KQB2R12-16	19	42.9	22.1	18.6	58.3	37.2

Note) Value of FEP tubing.

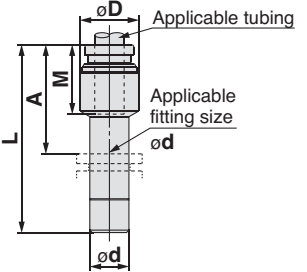

Different Diameter Straight: KQB2H



Applicable tubing O.D. (mm)		Model	øD Note 1)	L	M ₁	M ₂	Note 2)	Weight (g)
a	b						Effective area (mm ²)	
ø3.2	ø4	KQB2H23-04	9	25.6	12	12.6	3.4	6.8
ø4	ø6	KQB2H04-06	12	27.2	12.6	13.6	5.6	12.1
ø6	ø8	KQB2H06-08	14	30.7	13.6	16.1	13.1	17.1
ø8	ø10	KQB2H08-10	17	34.1	16.1	17	26.1	27.2
ø10	ø12	KQB2H10-12	19	36.6	17	18.6	41.5	34.8
ø12	ø16	KQB2H12-16	24.6	40.4	18.6	20.8	58.3	57.3

Note 1) For the ø16, this dimension refers to the O.D. of the release button.
Note 2) Value of FEP tubing.

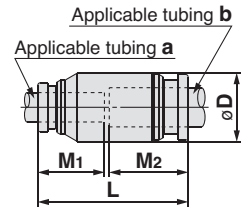

Different Diameter Union "Y": KQB2U



Applicable tubing O.D. (mm)		Model	Note 1)	L ₁	L ₂	P	W	M ₁	M ₂	øN	øO	Note 2)	Weight (g)
a	b		øD									Effective area (mm ²)	
ø3.2	ø4	KQB2U23-04	9.1	27	10.8	8.1	16.4	12	12.6	3.2	5.6	3.2	8.5
ø4	ø6	KQB2U04-06	11.4	29.3	11.2	9.1	18.2	12.6	13.6	3.2	5.6	4.2	11.9
ø6	ø8	KQB2U06-08	13.7	33.7	12.2	11.5	22.9	13.6	16.1	4.2	8	13.4	19.3
ø8	ø10	KQB2U08-10	16.6	38.3	13.8	14.6	28.3	16.1	17	4.2	8	25.6	32
ø10	ø12	KQB2U10-12	18.7	43	14	17.6	34.2	17	18.6	4.2	8	40	47.6
ø12	ø16	KQB2U12-16	24.6	47.4	15.6	19.8	38.5	18.6	20.8	4.2	8	57.4	67.6

Note 1) For the ø16, this dimension refers to the O.D. of the release button.
Note 2) Value of FEP tubing.

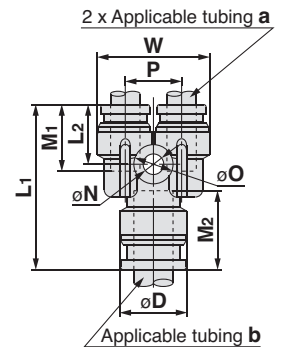

Metal One-touch Fittings **KQB2 Series**

Applicable Tubing: Metric Size, Connection Thread: M, R, Rc

Dimensions

Bulkhead Connector: KQB2E

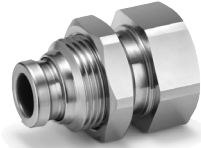

Applicable tubing O.D. (mm)	Connection thread Rc	Model	T (M)	Width across flat		L1	L2	Mounting hole	M	Note) Effective area (mm ²)	Weight (g)
				H1	H2						
ø3.2	1/4	KQB2E23-02	M10 x 1	17	12	31	14.8	11	12	3.4	27.5
ø4	1/8	KQB2E04-01	M10 x 1	14	12	25.8	9.7	11	12.6	5.6	16.9
	1/4	KQB2E04-02		17	12	30.9	14.8				27.1
ø6	1/8	KQB2E06-01	M14 x 1	17	17	24.2	6.1	15	13.6	13.1	25
	3/8	KQB2E06-03		19	17	31.6	13.5				33.2
ø8	1/8	KQB2E08-01	M15 x 1	17	19	26.3	6.9	16	16.1	26.1	28.7
	1/4	KQB2E08-02				32.4	13				34.2
	3/8	KQB2E08-03		19	19	34	14.6				35.9
ø10	1/4	KQB2E10-02	M18 x 1	19	21	31.6	11.6	19	17	41.5	44
	3/8	KQB2E10-03				33.6	13.6				40.2
ø12	3/8	KQB2E12-03	M20 x 1	21	24	34	12.8	21	18.6	58.3	52
	1/2	KQB2E12-04		24	24	39.6	18.4				62.5
ø16	3/8	KQB2E16-03	M27 x 1	29	30	35.3	11.2	28	20.8	96	111
	1/2	KQB2E16-04				40.6	16.5				113

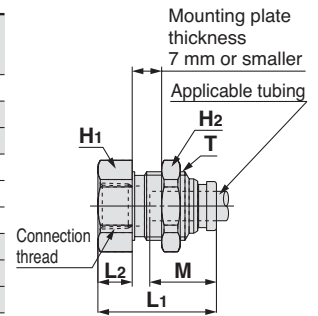

Note) Value of FEP tubing.
Value of nylon tubing for ø16 only.

Extended Male Elbow: KQB2W



Applicable tubing O.D. (mm)	Connection thread R, M	Model	H (Width across flat)	Note 1) øD	L1	L2	A*	M	Note 2) Effective area (mm ²)	Weight (g)
ø4	1/8	KQB2W23-01S	10	13.6	31.3	32.3	15.3			
	1/4	KQB2W23-02S	14	35.1	34.5	34.7				
ø6	M5 x 0.8	KQB2W04-M5	8	9.1	13.7	31.6	33.2	12.6	3	14.1
	1/8	KQB2W04-01S	10		14.4	31.7	33.1			16.2
1/4	KQB2W04-02S	14	35.5		35.3	35.6				
ø8	M5 x 0.8	KQB2W06-M5	8	11.4	14.7	32.7	35.4	13.6	3	16
	1/8	KQB2W06-01S	10		32.8	37.6	37.6			17.8
	1/4	KQB2W06-02S	14		36.6	37.6	37.2			
	3/8	KQB2W06-03S	17		38	38.6	60.3			
ø10	1/8	KQB2W08-01S	12	13.7	18.6	37	40.7	16.1	20.5	28.9
	1/4	KQB2W08-02S	14		19.1	40.2	42.3			39.2
	3/8	KQB2W08-03S	17		41.6	43.3	63.7			
ø12	1/4	KQB2W10-02S	14	16.6	21	46.6	50.2	17	33.5	42.1
	3/8	KQB2W10-03S	17		45.9	49.1	64.5			
ø16	1/2	KQB2W10-04S	22	18.7	23.6	50.1	52	18.6	47.7	123
	1/4	KQB2W12-02S	14		22.6	47.7	52.3			46
	3/8	KQB2W12-03S	17		49	53.2	58.2			
ø16	1/2	KQB2W12-04S	22	24.6	23.6	53.2	56.1	20.8	71	118
	3/8	KQB2W16-03S	19		26.3	57.6	64.1			89.6
1/2	KQB2W16-04S	22	27.3	61.4	66.6	100	116			

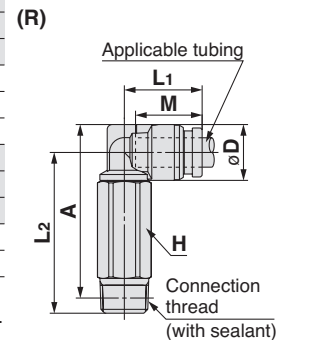
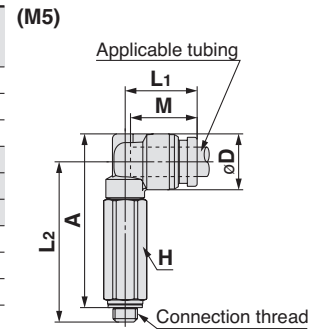

* Reference dimensions after installation for R thread
Note 1) For the ø16, this dimension refers to the O.D. of the release button.
Note 2) Value of FEP tubing.
Value of nylon tubing for ø16 only.

KQB2 Series

Applicable Tubing: Metric Size, Connection Thread: M, R, Rc

Dimensions

Female Connector: KQB2F



Applicable tubing O.D. (mm)	Connection thread Rc	Model	H (Width across flat)	Note 1) ϕD	L1	L2	M	Note 2) Effective area (mm ²)	Weight (g)
$\phi 3.2$	1/8	KQB2F23-01	12	8	23.3	9.8	12	3.4	9.3
$\phi 4$	1/8	KQB2F04-01	12	8.7	23.7	9.8	12.6	5.6	9.7
	1/4	KQB2F04-02	17		28.7	13.2			22.7
$\phi 6$	1/8	KQB2F06-01	12	11.1	24.2	10	13.6	13.1	11.1
	1/4	KQB2F06-02	17		29.2	13.4			24.3
$\phi 8$	3/8	KQB2F06-03	19	13.4	30.6	14.2	16.1	26.1	25.8
	1/8	KQB2F08-01	14		26.3	9.6			17.1
	1/4	KQB2F08-02	17		31.3	13.7			26.8
$\phi 10$	3/8	KQB2F08-03	19	16.4	32.7	14.4	17	41.5	28.4
	1/4	KQB2F10-02	17		31.6	13.9			30.3
	3/8	KQB2F10-03	19		33	14.7			32
$\phi 12$	1/4	KQB2F12-02	19	18.5	32.6	13.3	18.6	58.3	39.4
	3/8	KQB2F12-03			34	14.7			33.9
	1/2	KQB2F12-04	24		39.3	18.4			52.9
$\phi 16$	3/8	KQB2F16-03	24	24.6	35.3	13.5	20.8	81	62.8
	1/2	KQB2F16-04			40.6	18.8			113

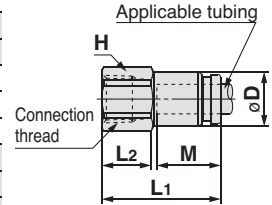

Note 1) For the $\phi 10$, $\phi 12$, and $\phi 16$, this dimension refers to the O.D. of the release button.
 Note 2) Value of FEP tubing.
 Value of nylon tubing for $\phi 16$ only.

Plug: KQB2P



Applicable fitting size ϕd	Model	ϕD	L	A	Weight (g)
$\phi 3.2$	KQB2P-23	5	28.9	16.9	2.8
$\phi 4$	KQB2P-04	6	29.6	17	4.3
$\phi 6$	KQB2P-06	8	30.8	17.2	9
$\phi 8$	KQB2P-08	10	33.7	17.6	16.3
$\phi 10$	KQB2P-10	12	34.6	17.6	25.4
$\phi 12$	KQB2P-12	14	36.5	17.9	37.8
$\phi 16$	KQB2P-16	18	38.6	17.8	69.2

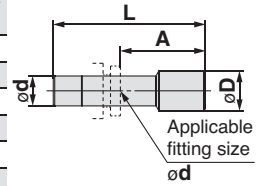

Related Equipment

Spatter cover

(Applicable tubing: FR soft nylon, FR double layer, FR three-layer)



Applicable tubing O.D. (mm)	Model
$\phi 6$	KQB2-06C-X1124
$\phi 8$	KQB2-08C-X1124
$\phi 10$	KQB2-10C-X1124

- * Since the spatter cover is designed for multi-layer (double layer, three-layer) tubing, sufficient effects cannot be obtained in foreign matter flow-in or followability for singlelayer tubing.
- * The cover can be attached regardless of the single-layer/multi-layer tubing.
- * Cannot be used for union "Y" (KQB2U) 2-port side.

Metal One-touch Fittings

Applicable Tube: Inch Size, Connection Thread: UNF, NPT

Series **KQB2**

RoHS



Applicable Tube

Tube material	FEP, PFA, Nylon, Soft nylon, Polyurethane, Polyolefin
Tube O.D.	ø1/8", ø5/32", ø1/4", ø5/16", ø3/8", ø1/2"

Specifications

Fluid	Air, N ₂ , Water ^{Note 2)}
Operating pressure range ^{Note 1)}	-100 kPa to 1 MPa ^{Note 3)}
Proof pressure	3.0 MPa
Ambient and fluid temperature ^{Note 4)}	-5 to 150°C (No freezing) ^{Note 3)}
Lubricant	Grease-free specification
Seal on the threads	With sealant

- Note 1) Avoid using in a vacuum holding application such as a leak tester, since there is leakage.
 Note 2) Deionized water is not recommended for use as it may affect the material used in the fittings. In addition, it is known to degrade the water quality.
 Note 3) Check the operating pressure range and operating temperature range of the tubing.
 Note 4) It is recommended that you use the inner sleeve in the following conditions (Except ø1/8"):
- When using in an environment where the fluid temperature changes drastically.
 - When using at a high temperature.

* Temperature Condition of Mounting the Inner Sleeve

Tubing	Temperature
FEP tubing/TH Series	80°C or more
Super PFA tubing/TL Series	120°C or more

Spare Parts

Description	Tube O.D.	Part no.	Material
Gasket	—	M-5G3	Stainless steel 316, Special FKM
Bulkhead nut	ø1/8" ø5/32"	KQB201-P01	C3604 (Electroless nickel plated)
	ø1/4"	KQB207-P01	
	ø5/16"	KQB209-P01	
	ø3/8"	KQB211-P01	
	ø1/2"	KQB213-P01	

Cross Reference Table of the Inner Sleeve

Tubing O.D.	Tubing material		Applicable inner sleeve	
	TH/THI (FEP)	TL/TIL (Super PFA)	Part no.	Length
ø5/32"	TH0402	—	TJ-0402	18
	TH0425	—	TJ-0425	18
	—	TL0403	TJ-0403	18
ø1/4"	TIHB07	TIL07	TJ-0604	19
	TIHA07	—	TJ-0746	19
ø5/16"	TH0806	TL0806	TJ-0806	20.5
ø3/8"	TIHB11	TIL11	TJ-1065	23
	TIHA11	—	TJ-1107	23
ø1/2"	TIH13	TIL13	TJ-1395	24

* C2700 + Electroless nickel plated is used for the TJ series.

Construction

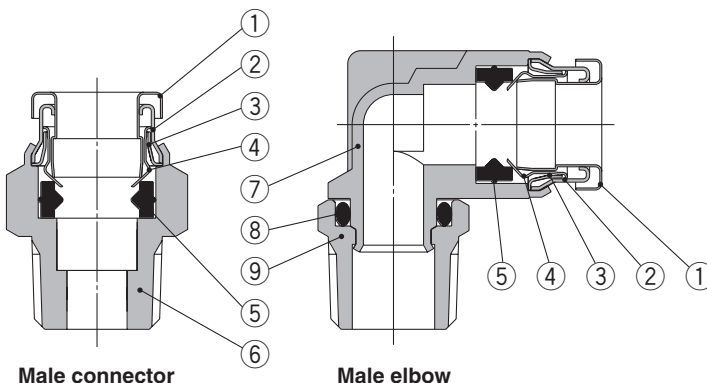

Component Parts

No.	Description	Material
1	Release button	Stainless steel 304
2	Guide 1	Stainless steel 304
3	Guide 2	Stainless steel 304
4	Chuck	Stainless steel 304
5	Seal	Special FKM (Fluoro coated)
6	Male connector body	C3604 (Electroless nickel plated)
7	Male elbow body	Stainless steel 316
8	O-ring	Special FKM (Fluoro coated)
9	Stud	C3604 (Electroless nickel plated)

KQB2 Series

Applicable Tubing: Inch Size, Connection Thread: UNF, NPT

Dimensions

Male Connector: KQB2H



Applicable tubing O.D. (inch)	Connection thread UNF, NPT	Model	H (Width across flat)	L	A*	M	Note) Effective area (mm ²)	Weight (g)
ø1/8"	10-32UNF	KQB2H01-32	8	16.5	13.5	12	3	3.5
	1/8	KQB2H01-N01S	11.11	17.1	13.9		3.4	7.9
	1/4	KQB2H01-N02S	14.29	20.9	16.5			18
ø5/32"	10-32UNF	KQB2H03-32	11.11	17.1	14.1	12.6	4	6.5
	1/8	KQB2H03-N01S		17	13.8		5.6	7.4
	1/4	KQB2H03-N02S	14.29	20.9	16.5			17.5
ø1/4"	10-32UNF	KQB2H07-32	12.7	19	16	13.5	4	9
	1/8	KQB2H07-N01S		20	16.8			9.8
	1/4	KQB2H07-N02S	14.29	20.6	16.2		13.1	15.1
	3/8	KQB2H07-N03S	17.46	23.8	19.1			31
ø5/16"	1/8	KQB2H09-N01S	14.29	24.2	21	16.1	26.1	13.8
	1/4	KQB2H09-N02S		23.1	18.7		26.1	14.9
	3/8	KQB2H09-N03S	17.46	24.6	19.9			28.3
ø3/8"	1/8	KQB2H11-N01S	17.46	25	21.8	16.6	26.1	21.5
	1/4	KQB2H11-N02S		26.3	21.9			22.3
	3/8	KQB2H11-N03S		23.6	18.9		41.5	24.4
ø1/2"	1/2	KQB2H11-N04S	22.23	28.3	21.9	18.5		55
	1/4	KQB2H13-N02S	22.23	30.5	26.1		58.3	39.4
	3/8	KQB2H13-N03S		28.4	23.7			36.8
	1/2	KQB2H13-N04S			22		46.1	

* Reference dimensions after installation for NPT thread
Note) Value of FEP tubing.

(10-32UNF)

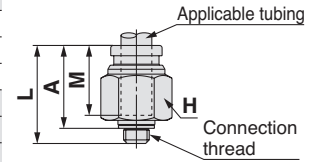

(NPT)

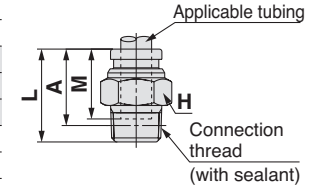

Hexagon Socket Head Male Connector: KQB2S



Applicable tubing O.D. (inch)	Connection thread UNF, NPT	Model	H (Width across flat)	øD	L	A*	M	Note) Effective area (mm ²)	Weight (g)
ø1/8"	10-32UNF	KQB2S01-32	2	9	16.5	13.5	12	3	3.9
ø5/32"	10-32UNF	KQB2S03-32	2	9	17.1	14.1	12.6	4	3.9
	1/8	KQB2S03-N01S	2.78	11	21.4	18.2		4.1	8.9
ø1/4"	10-32UNF	KQB2S07-32	2	12	19.5	16.5	13.5	4	7.5
	1/8	KQB2S07-N01S	4.76		20.5	17.3		10	8.5
	1/4	KQB2S07-N02S		14	16.1	10.7		14.1	
	3/8	KQB2S07-N03S	18	21.5	16.8			23.8	
ø5/16"	1/8	KQB2S09-N01S	5.56	14	24.7	21.5	16.1	17.2	12.6
	1/4	KQB2S09-N02S	6.35		23.1	18.7		23.3	13.4
	3/8	KQB2S09-N03S		18	18.4			24.7	
ø3/8"	1/8	KQB2S11-N01S	5.56	17	25.2	22	16.6	17.2	18.7
	1/4	KQB2S11-N02S	6.35		27.1	22.7			22.2
	3/8	KQB2S11-N03S		18	18.9	39		25	
	1/2	KQB2S11-N04S	22	23.6	17.2			40.6	
ø1/2"	1/4	KQB2S13-N02S	8	20	30.5	26.1	18.5	46	27.9
	3/8	KQB2S13-N03S	9.53		29.4	24.7		60	30.4
	1/2	KQB2S13-N04S			22	25.5		19.1	

* Reference dimensions after installation for NPT thread
Note) Value of FEP tubing.

(10-32UNF)

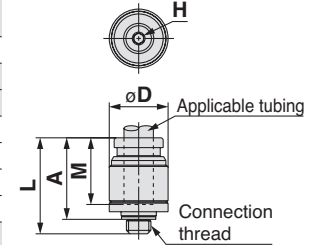

(NPT)

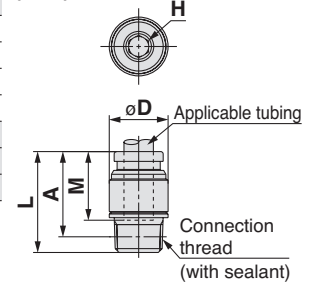

Straight Union: KQB2H



Applicable tubing O.D. (inch)	Model	øD	L	M	Note) Effective area (mm ²)	Weight (g)
ø1/8"	KQB2H01-00	9	25	12	3.4	6.8
ø5/32"	KQB2H03-00	9	26.2	12.6	5.6	6.8
ø1/4"	KQB2H07-00	12	28	13.5	13.1	11.5
ø5/16"	KQB2H09-00	14	33.2	16.1	26.1	17.4
ø3/8"	KQB2H11-00	16	34.2	16.6	41.5	23.7
ø1/2"	KQB2H13-00	20	38	18.5	58.3	37

Note) Value of FEP tubing.

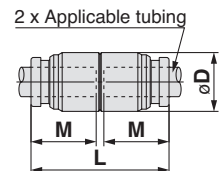

Metal One-touch Fittings **KQB2 Series**

Applicable Tubing: Inch Size, Connection Thread: UNF, NPT

Dimensions

Male Elbow: KQB2L



Applicable tubing O.D. (inch)	Connection thread UNF, NPT	Model	H (Width across flat)	øD	L1	L2	A*	M	Note) Effective area (mm ²)	Weight (g)
ø1/8"	10-32UNF	KQB2L01-32	8	8.3	13.1	14.8	16	12	2.6	6.5
	1/8	KQB2L01-N01S	11.11		13.6	14.9	15.8		3	8.8
	1/4	KQB2L01-N02S	14.29		18.7	18.4	17.7			
ø5/32"	10-32UNF	KQB2L03-32	8	9.1	13.7	15.2	16.8	12.6	3.5	7
	1/8	KQB2L03-N01S	11.11		14.4	15.3	16.6		4.2	9.7
	1/4	KQB2L03-N02S	14.29		19.1	19.2	18.5			
ø1/4"	10-32UNF	KQB2L07-32	8	11.7	14.7	16.5	19.3	13.5	3.5	9.1
	1/8	KQB2L07-N01S	11.11		15.9	16.6	19.2		11.4	11.4
	1/4	KQB2L07-N02S	14.29		20.4	21.8	20.3			
	3/8	KQB2L07-N03S	17.46		22.2	23.3	33.7			
ø5/16"	1/8	KQB2L09-N01S	12.7	13.7	18.6	18.3	21.9	16.1	21.6	15.8
	1/4	KQB2L09-N02S	14.29		19.1	21.5	23.9		21.9	
	3/8	KQB2L09-N03S	17.46		23.3	25.4	35			
ø3/8"	1/8	KQB2L11-N01S	12.7	16	20	19.4	24.2	16.6	21.6	20.5
	1/4	KQB2L11-N02S	14.29		21	22.6	26.2		23.9	
	3/8	KQB2L11-N03S	17.46		24.4	27.7	35.8			
	1/2	KQB2L11-N04S	22.23		28.2	29.8	63.1			
ø1/2"	1/4	KQB2L13-N02S	14.29	19.6	22.7	24.4	29.8	18.5	50.2	30.1
	3/8	KQB2L13-N03S	17.46		23.7	26.1	31.2		37.9	
	1/2	KQB2L13-N04S	22.23		29.9	33.3	63.8			

(10-32UNF)

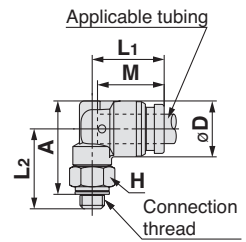

(NPT)

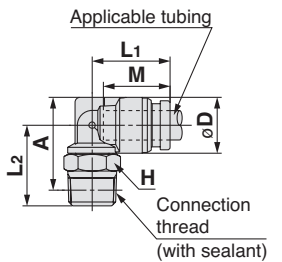

* Reference dimensions after installation for NPT thread
Note) Value of FEP tubing.

Male Branch Tee: KQB2T



Applicable tubing O.D. (inch)	Connection thread UNF, NPT	Model	H (Width across flat)	øD	L1	L2	A*	M	Note) Effective area (mm ²)	Weight (g)
ø1/8"	10-32UNF	KQB2T01-32	8	8.3	13.1	14.8	16	12	3.2	8.2
	1/8	KQB2T01-N01S	11.11		13.6	14.9	15.8		3.4	10.6
	1/4	KQB2T01-N02S	14.29		18.7	18.4	19.5			
ø5/32"	10-32UNF	KQB2T03-32	8	9.1	13.7	15.2	16.8	12.6	4.5	9.1
	1/8	KQB2T03-N01S	11.11		14.4	15.3	16.6		6	11.6
	1/4	KQB2T03-N02S	14.29		19.1	19.2	20.5			
ø1/4"	10-32UNF	KQB2T07-32	8	11.7	14.7	16.5	19.3	13.5	4.5	12.3
	1/8	KQB2T07-N01S	11.11		15.9	16.6	19.2		13.9	14.9
	1/4	KQB2T07-N02S	14.29		20.4	21.8	23.8			
	3/8	KQB2T07-N03S	17.46		22.2	23.3	37.1			
ø5/16"	1/8	KQB2T09-N01S	12.7	13.7	18.6	18.3	21.9	16.1	26.3	21.2
	1/4	KQB2T09-N02S	14.29		19.1	21.5	23.9		27.1	
	3/8	KQB2T09-N03S	17.46		23.3	25.4	40.3			
ø3/8"	1/8	KQB2T11-N01S	12.7	16	20	19.4	24.2	16.6	40.8	28.1
	1/4	KQB2T11-N02S	14.29		21	22.6	26.2		31.1	
	3/8	KQB2T11-N03S	17.46		24.4	27.7	43.1			
	1/2	KQB2T11-N04S	22.23		28.2	29.8	70.4			
ø1/2"	1/4	KQB2T13-N02S	14.29	19.6	22.7	24.4	29.8	18.5	57.2	41.8
	3/8	KQB2T13-N03S	17.46		23.7	26.1	31.2		49	
	1/2	KQB2T13-N04S	22.23		29.9	33.3	74.9			

(10-32UNF)

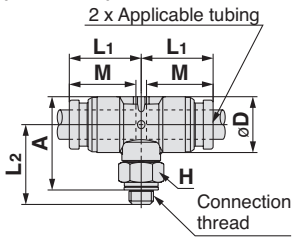

(NPT)

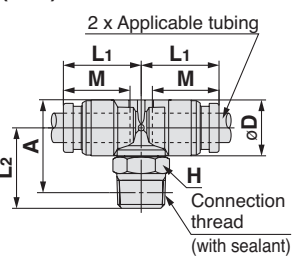

* Reference dimensions after installation for NPT thread
Note) Value of FEP tubing.

Union Elbow: KQB2L



Applicable tubing O.D. (inch)	Model	øD	L	A	Q	M	øN	øO	Note) Effective area (mm ²)	Weight (g)
ø1/8"	KQB2L01-00	8.3	13.6	19.3	2.9	12	3.2	5.6	3	6.3
ø5/32"	KQB2L03-00	9.1	14.6	20.5	3.1	12.6	3.2	5.6	4.2	7.4
ø1/4"	KQB2L07-00	11.7	16.7	23.2	3.7	13.5	3.2	5.6	11.4	11.5
ø5/16"	KQB2L09-00	13.7	20.1	29.1	5	16.1	4.2	8	21.6	20.2
ø3/8"	KQB2L11-00	16	21.4	31.1	5.7	16.6	4.2	8	35.2	28.2
ø1/2"	KQB2L13-00	19.6	24.9	35.3	6.4	18.5	4.2	8	50.2	41.7

Note) Value of FEP tubing.

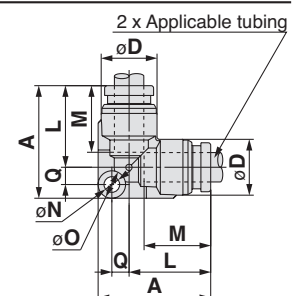

KQB2 Series

Applicable Tubing: Inch Size, Connection Thread: UNF, NPT

Dimensions

Bulkhead Union: KQB2E



Applicable tubing O.D. (inch)	Model	T (UNF)	H (Width across flat)	L	Mounting hole	M	Note) Effective area (mm ²)	Weight (g)
ø1/8"	KQB2E01-00	7/16-20UNF	14.29	34.2	12.5	12	3.4	21.8
ø5/32"	KQB2E03-00	7/16-20UNF	14.29	34.4	12.5	12.6	5.6	21.6
ø1/4"	KQB2E07-00	1/2-20UNF	17.46	36.2	14	13.5	13.1	30.2
ø5/16"	KQB2E09-00	5/8-18UNF	22.23	41.2	17	16.1	26.1	43.9
ø3/8"	KQB2E11-00	3/4-16UNF	22.23	42.4	20.5	16.6	41.5	64.2
ø1/2"	KQB2E13-00	7/8-14UNF	25.4	47	23.5	18.5	58.3	94.2

Note) Value of FEP tubing.

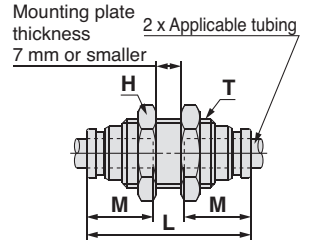

Union Tee: KQB2T



Applicable tubing O.D. (inch)	Model	øD	L	A	Q	M	øN	øO	Note) Effective area (mm ²)	Weight (g)
ø1/8"	KQB2T01-00	8.3	13.6	20.5	4.1	12	3.2	5.6	3.4	7.9
ø5/32"	KQB2T03-00	9.1	14.6	21.8	4.4	12.6	3.2	5.6	6.4	9.5
ø1/4"	KQB2T07-00	11.7	16.7	24.7	5.2	13.5	3.2	5.6	13.4	14.7
ø5/16"	KQB2T09-00	13.7	20.1	31.1	7	16.1	4.2	8	25.6	24.4
ø3/8"	KQB2T11-00	16	21.4	33.4	8	16.6	4.2	8	40	34.7
ø1/2"	KQB2T13-00	19.6	24.9	37.9	9	18.5	4.2	8	57.4	52.3

Note) Value of FEP tubing.

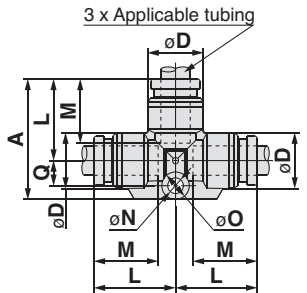

Union "Y": KQB2U



Applicable tubing O.D. (inch)	Model	øD	W	L1	L2	P	M	øN	øO	Note) Effective area (mm ²)	Weight (g)
ø1/8"	KQB2U01-00	8.3	16.4	29	11	8.1	12	3.2	5.6	3.4	9.2
ø5/32"	KQB2U03-00	9.1	18.2	30.4	11.3	9.1	12.6	3.2	5.6	4.2	11.1
ø1/4"	KQB2U07-00	11.7	23.9	34.5	12.1	12.2	13.5	3.2	5.6	13.4	19.6
ø5/16"	KQB2U09-00	13.7	28.3	40.1	14.1	14.6	16.1	4.2	8	25.6	29.7
ø3/8"	KQB2U11-00	16	33.2	42.2	14	17.2	16.6	4.2	8	40	43.1
ø1/2"	KQB2U13-00	19.6	40.2	47.3	15.8	20.6	18.5	4.2	8	57.4	66.4

Note) Value of FEP tubing.

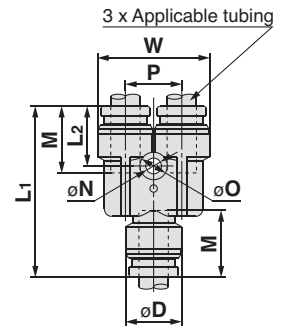

Different Diameter Tee: KQB2T



Applicable tubing O.D. (inch)	Model	øD1	øD2	L1	L2	L3	Q	M1	M2	øN	øO	Note) Effective area (mm ²)	Weight (g)
ø1/8" ø5/32"	KQB2T01-03	9.1	8.3	14.2	14.1	21.1	4.1	12.6	12	3.2	5.6	3.8	8.5
ø5/32" ø1/4"	KQB2T03-07	11.7	9.1	15.5	15.9	22.7	4.4	13.5	12.6	3.2	5.6	7.1	11.7
ø1/4" ø5/16"	KQB2T07-09	13.7	11.7	19.3	17.6	29.6	6.3	16.1	13.5	4.2	8	16.4	20.2
ø5/16" ø3/8"	KQB2T09-11	16	13.7	20.6	21	31.7	7.1	16.6	16.1	4.2	8	36	28.9
ø3/8" ø1/2"	KQB2T11-13	19.6	16	23.3	23	35.4	8.1	18.5	16.6	4.2	8	56	41.8

Note) Value of FEP tubing.

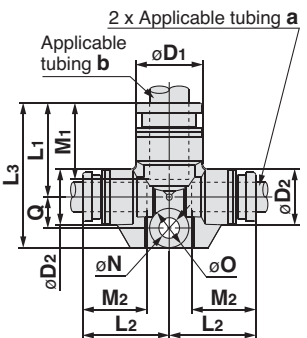

Plug-in Reducer: KQB2R



Applicable tubing O.D. (inch)	Applicable fitting size ød	Model	øD	L	A	M	Note) Effective area (mm ²)	Weight (g)
ø1/8"	ø5/32"	KQB2R01-03	9	32.9	20.3	12	3.4	4.9
ø5/32"	ø1/4"	KQB2R03-07	9	33.7	20.2	12.6	5.6	7.4
ø1/4"	ø5/16"	KQB2R07-09	12	38.4	22.3	13.5	13.1	12.5
ø5/16"	ø3/8"	KQB2R09-11	14	41.6	25	16.1	26.1	17.7
ø3/8"	ø1/2"	KQB2R11-13	17	39.8	21.3	16.6	41.5	24.7

Note) Value of FEP tubing.

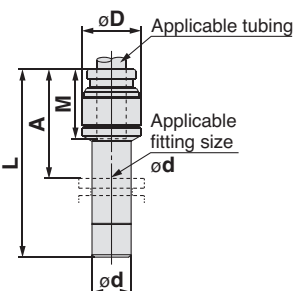

Dimensions

Different Diameter Straight: KQB2H



Applicable tubing O.D. (inch)		Model	øD	L	M1	M2	Note) Effective area (mm ²)	Weight (g)
a	b							
ø1/8"	ø5/32"	KQB2H01-03	9	25.6	12	12.6	3.4	6.8
ø5/32"	ø1/4"	KQB2H03-07	12	27.1	12.6	13.5	5.6	11.9
ø1/4"	ø5/16"	KQB2H07-09	14	30.6	13.5	16.1	13.1	16.8
ø5/16"	ø3/8"	KQB2H09-11	16	33.7	16.1	16.6	26.1	23.9
ø3/8"	ø1/2"	KQB2H11-13	20	36.1	16.6	18.5	41.5	38.8

Note) Value of FEP tubing.

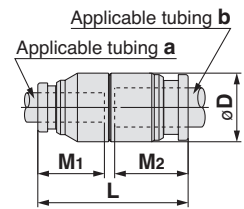

Different Diameter Union "Y": KQB2U



Applicable tubing O.D. (inch)		Model	øD	L1	L2	P	W	M1	M2	øN	øO	Note) Effective area (mm ²)	Weight (g)
a	b												
ø1/8"	ø5/32"	KQB2U01-03	9.1	27	10.8	8.1	16.4	12	12.6	3.2	5.6	3.2	8.5
ø5/32"	ø1/4"	KQB2U03-07	11.7	28.8	11.4	9.1	18.2	12.6	13.5	3.2	5.6	4.2	11.8
ø1/4"	ø5/16"	KQB2U07-09	13.7	33.8	12	12.2	23.9	13.5	16.1	4.2	8	13.4	20
ø5/16"	ø3/8"	KQB2U09-11	16	38.3	13.8	14.6	28.3	16.1	16.6	4.2	8	25.6	31
ø3/8"	ø1/2"	KQB2U11-13	19.6	40.5	13.7	17.2	33.2	16.6	18.5	4.2	8	40	45

Note) Value of FEP tubing.

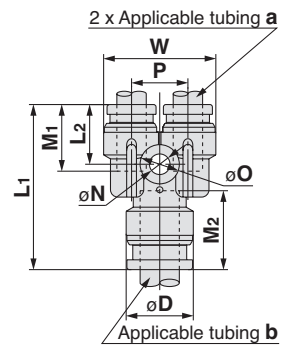

Bulkhead Connector: KQB2E

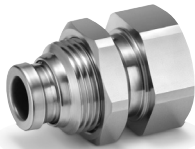

Applicable tubing O.D. (inch)	Connection thread NPT	Model	T (UNF)	Width across flat		L1	L2	Mounting hole	M	Note) Effective area (mm ²)	Weight (g)
				H1	H2						
ø1/8"	1/4	KQB2E01-N02	7/16-20UNF	17.46	14.29	32.8	15.3	12.5	12	3.4	34.1
ø5/32"	1/4	KQB2E03-N02	7/16-20UNF	17.46	14.29	32.6	15.3	12.5	12.6	5.6	33.5
ø1/4"	1/4	KQB2E07-N02	1/2-20UNF	17.46	17.46	33.1	14.8	14	13.5	13.1	36.5
ø5/16"	3/8	KQB2E09-N03	5/8-18UNF	22.23	22.23	35.8	15.1	17	16.1	26.1	56.1
ø3/8"	3/8	KQB2E11-N03	3/4-16UNF	22.23	22.23	35.2	13.7	20.5	16.6	41.5	62.9
ø1/2"	3/8	KQB2E13-N03	7/8-14UNF	23.81	25.4	34.6	11	23.5	18.5	58.3	76.6
	1/2	KQB2E13-N04				42.2	18.6				80.2

Note) Value of FEP tubing.

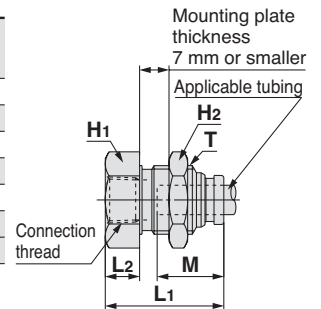

Extended Male Elbow: KQB2W



Applicable tubing O.D. (inch)	Connection thread NPT	Model	H (Width across flat)	øD	L1	L2	A*	M	Note) Effective area (mm ²)	Weight (g)
	1/4	KQB2W01-N02S	14.29	35.4	35.1	37.3				
ø5/32"	1/8	KQB2W03-N01S	11.11	9.1	14.4	32	33.3	12.6	4	20.3
		1/4	KQB2W03-N02S			14.29	35.8			35.9
ø1/4"	1/8	KQB2W07-N01S	11.11	11.7	15.9	33.3	35.9	13.5	10.9	22.1
	1/4	KQB2W07-N02S	14.29			37.1	38.5			39.9
	3/8	KQB2W07-N03S	17.46			38.9	40			65.6
ø5/16"	1/8	KQB2W09-N01S	12.7	13.7	18.6	34.7	38.3	16.1	20.5	30.4
	1/4	KQB2W09-N02S	14.29			40.2	42.6			41.6
	3/8	KQB2W09-N03S	17.46			42	44.1			68.5
ø3/8"	1/4	KQB2W11-N02S	14.29	16	21	47.2	50.8	16.6	33.5	44.9
	3/8	KQB2W11-N03S	17.46			45.4	48.7			67.8
	1/2	KQB2W11-N04S	22.23			49.2	50.8			124.2
ø1/2"	1/4	KQB2W13-N02S	14.29	19.6	23.7	22.7	49	18.5	47.7	51.1
	3/8	KQB2W13-N03S	17.46			50.7	55.8			66
	1/2	KQB2W13-N04S	22.23			54.5	57.9			125.9

* Reference dimensions after installation of NPT thread
Note) Value of FEP tubing.

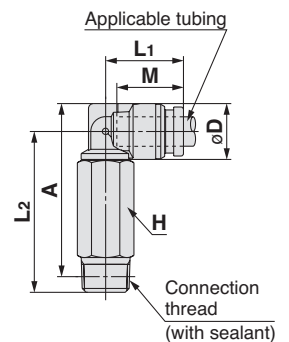

KQB2 Series

Applicable Tubing: Inch Size, Connection Thread: UNF, NPT

Dimensions

Female Connector: KQB2F



Applicable tubing O.D. (inch)	Connection thread NPT	Model	H (Width across flat)	Note 1) ϕD	L1	L2	M	Note 2) Effective area (mm ²)	Weight (g)
$\phi 1/8$ "	1/8	KQB2F01-N01	12.7	8	24.1	10.4	12	3.4	11.3
	1/4	KQB2F01-N02	17.46		29.1	13.7			25.4
$\phi 5/32$ "	1/8	KQB2F03-N01	12.7	8.7	24.6	10.5	12.6	5.6	11.8
	1/4	KQB2F03-N02	17.46		29.6	13.8			25.9
$\phi 1/4$ "	1/8	KQB2F07-N01	12.7	11.2	25	10.7	13.5	13.1	13
	1/4	KQB2F07-N02	17.46		30	14.1			27.5
	3/8	KQB2F07-N03	22.23		31.2	14.6			41.1
$\phi 5/16$ "	1/8	KQB2F09-N01	14.29	13.4	27.2	10.3	16.1	26.1	18.8
	1/4	KQB2F09-N02	17.46		32.2	14.3			30.1
	3/8	KQB2F09-N03	22.23		33.4	14.8			44
$\phi 3/8$ "	1/4	KQB2F11-N02	17.46	16	32.1	14.4	16.6	41.5	32.9
	3/8	KQB2F11-N03	22.23		33.3	14.9			47
	1/2	KQB2F11-N04	23.81		38.6	18.6			50.4
$\phi 1/2$ "	3/8	KQB2F13-N03	22.23	19.3	34.6	14.7	18.5	58.3	51.3
	1/2	KQB2F13-N04	23.81		39.9	18.8			55.1

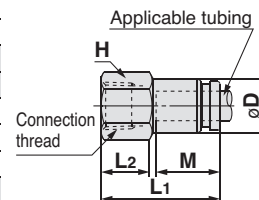

Note 1) For the $\phi 3/8$ ", this dimension refers to the O.D. of the release button.
 Note 2) Value of FEP tubing.

Plug: KQB2P



Applicable fitting size ϕd	Model	ϕD	L	A	Weight (g)
$\phi 1/8$ "	KQB2P-01	5	28.9	16.9	2.8
$\phi 5/32$ "	KQB2P-03	6	29.6	17	4.3
$\phi 1/4$ "	KQB2P-07	8	30.3	16.8	9.4
$\phi 5/16$ "	KQB2P-09	10	33.7	17.6	16.3
$\phi 3/8$ "	KQB2P-11	11	34.1	17.5	22.2
$\phi 1/2$ "	KQB2P-13	14	36.4	17.9	40.7

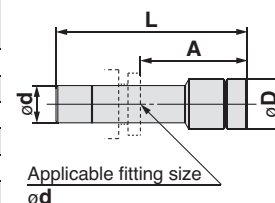

Metal One-touch Fittings

Applicable Tube: Metric Size, Connection Thread: G

Series **KQB2**

RoHS



Applicable Tube

Tube material	FEP, PFA, Nylon, Soft nylon, Polyurethane, Polyolefin
Tube O.D.	ø4, ø6, ø8, ø10, ø12, ø16

Specifications

Fluid	Air, N ₂ , Water ^{Note 2)}
Operating pressure range ^{Note 1)}	-100 kPa to 1 MPa ^{Note 3)}
Proof pressure	3.0 MPa
Ambient and fluid temperature ^{Note 4)}	-5 to 150°C (No freezing) ^{Note 3)}
Lubricant	Grease-free specification
Seal on the threads	O-ring seal

- Note 1) Avoid using in a vacuum holding application such as a leak tester, since there is leakage.
 Note 2) Deionized water is not recommended for use as it may affect the material used in the fittings. In addition, it is known to degrade the water quality.
 Note 3) Check the operating pressure range and operating temperature range of the tubing.
 Note 4) It is recommended that you use the inner sleeve in the following conditions:
- When using in an environment where the fluid temperature changes drastically.
 - When using at a high temperature.

* Temperature Condition of Mounting the Inner Sleeve

Tube	Temperature
FEP tube/TH series	80C or more
PFA tube/TL series	120C or more

Spare Parts

Description	Tube O.D.	Part no.	Material
Bulkhead nut	ø4	KQB223-P01	C3604 (Electroless nickel plated)
	ø6	KQB206-P01	
	ø8	KQB208-P01	
	ø10	KQB210-P01	
	ø12	KQB212-P01	
	ø16	KQB216-P01	

Description	Thread size	Part no.	Material
G thread O-ring	G1/8	KQB2-G01	Special FKM (Fluoro coated)
	G1/4	KQB2-G02	
	G3/8	KQB2-G03	
	G1/2	KQB2-G04	

Cross Reference Table of the Inner Sleeve

Tube O.D.	Tube material			Applicable inner sleeve	
	TUS (Soft polyurethane)	TH/TH (FEP)	TL/TIL (PFA)	Part no.	Length
ø4	—	TH0402	—	TJ-0402	18
	TUS0425	TH0425	—	TJ-0425	18
ø6	—	—	TL0403	TJ-0403	18
	TUS0604	TH0604	TL0604	TJ-0604	19
	TUS0805	—	—	TJ-0805	20.5
ø8	—	TH0806	TL0806	TJ-0806	20.5
	TUS1065	—	—	TJ-1065	23
	—	TH1075	—	TJ-1075	23
ø10	—	TH1008	TL1008	TJ-1008	23
	TUS1208	—	—	TJ-1208	24
	—	TH1209	—	TJ-1209	24
ø12	—	TH1210	TL1210	TJ-1210	24
	—	—	—	—	—

* C2700 + Electroless nickel plated is used for the TJ series.

Construction

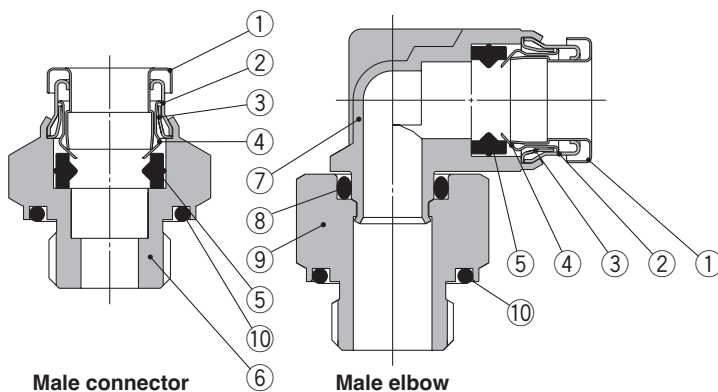

Component Parts

No.	Description	Material
1	Release button	Stainless steel 304
2	Guide 1	Stainless steel 304
3	Guide 2	Stainless steel 304
4	Chuck	Stainless steel 304
5	Seal	Special FKM (Fluoro coated)
6	Male connector body	C3604 (Electroless nickel plated)
7	Male elbow body	Stainless steel 316
8	O-ring	Special FKM (Fluoro coated)
9	Stud	C3604 (Electroless nickel plated)
10	G thread O-ring	Special FKM (Fluoro coated)

KQB2 Series

Applicable Tubing: Metric Size, Connection Thread: G

Dimensions

Male Connector: KQB2H



Applicable tubing O.D. (mm)	Connection thread G	Model	H (Width across flat)	ϕD	ϕd	L	A	M	Note) Effective area (mm ²)	Weight (g)
$\phi 4$	1/8	KQB2H04-G01	14	—	13.8	16.6	11.1	12.6	5.6	9.2
	1/4	KQB2H04-G02	19		17.8	20.6	14.1			23.6
$\phi 6$	1/8	KQB2H06-G01	14	—	13.8	17.6	12.1	13.6	13.1	8.9
	1/4	KQB2H06-G02	19		17.8	20.5	14			21.6
	3/8	KQB2H06-G03	22		21.8	23.4	15.9			38.3
$\phi 8$	1/8	KQB2H08-G01	14	—	13.8	23.9	18.4	16.1	26.1	13.2
	1/4	KQB2H08-G02	19		17.8	21.2	14.7			19.1
	3/8	KQB2H08-G03	22		21.8	24	16.5			35.2
$\phi 10$	1/8	KQB2H10-G01	17	—	13.8	25.1	19.6	17	26.1	19.9
	1/4	KQB2H10-G02	19		17.8	24.9	18.4			24.8
	3/8	KQB2H10-G03	22		21.8	23.3	15.8	41.5	30.9	
	1/2	KQB2H10-G04	27		26.5	27.7	18.7	64.4		
$\phi 12$	1/4	KQB2H12-G02	19	—	17.8	27.7	21.2	18.6	58.3	26.3
	3/8	KQB2H12-G03	22		21.8	23.5	16			25.5
	1/2	KQB2H12-G04	27		26.5	27.9	18.9			58
$\phi 16$	3/8	KQB2H16-G03	24	24.6	21.8	31.3	23.8	20.8	81	44.5
	1/2	KQB2H16-G04	27		26.5	27.3	18.3			113

Note) Value of FEP tubing.
Value of nylon tubing for $\phi 16$ only.

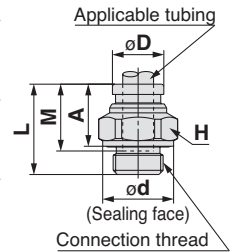

Hexagon Socket Head Male Connector: KQB2S



Applicable tubing O.D. (mm)	Connection thread G	Model	H (Width across flat)	Note 1) ϕD	ϕd	L	A	M	Note 2) Effective area (mm ²)	Weight (g)
$\phi 4$	1/8	KQB2S04-G01	3	14	14	20.4	14.9	12.6	4.1	13.5
	1/8	KQB2S06-G01	4	14	14	20.6	15.1	13.6	10	12.1
1/4	KQB2S06-G02	18		18	10.7		19.9			
$\phi 6$	1/8	KQB2S08-G01	5	14	14	23.9	18.4	16.1	17.2	12.5
	1/4	KQB2S08-G02	6	18	18	22.9	16.4		23.3	20.1
	3/8	KQB2S08-G03		22	22	23.1	15.6		31.1	
$\phi 8$	1/8	KQB2S10-G01	5	17	14	25.1	19.6	17	17.2	18.5
	1/4	KQB2S10-G02	8	18	18	24.9	18.4		39	20.4
	3/8	KQB2S10-G03		22	22	16.5	31.2			
	1/2	KQB2S10-G04	27	26.5	24	15	45.3			
$\phi 10$	1/4	KQB2S12-G02	8	19	18	27.7	21.2	18.6	46	23.6
	3/8	KQB2S12-G03	10	22	22	24.9	17.4		60	27.4
	1/2	KQB2S12-G04		27	26.5	15.9	42.6			
$\phi 16$	3/8	KQB2S16-G03	10	24.6	22	31.3	23.8	20.8	81	41
	1/2	KQB2S16-G04	12	27	26.5	27.8	18.8		113	42.9

Note 1) For the KQB2S16-G03, this dimension refers to the O.D. of the release button.
Note 2) Value of FEP tubing.
Value of nylon tubing for $\phi 16$ only.

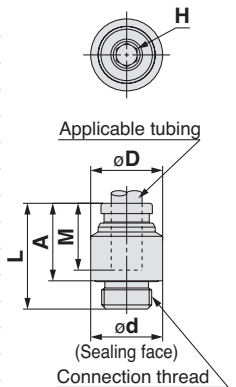

Dimensions

Male Elbow: KQB2L

Applicable tubing O.D. (mm)	Connection thread G	Model	H (Width across flat)	Note 1) ϕD	ϕd	L1	L2	A	M	Note 2) Effective area (mm ²)	Weight (g)
$\phi 4$	1/8	KQB2L04-G01	14	9.1	13.8	14.4	18.9	17.9	12.6	4.2	15.6
	1/4	KQB2L04-G02	19		17.8		22.3	20.3			33
$\phi 6$	1/8	KQB2L06-G01	14	11.4	13.8	15.9	20	20.2	13.6	11.4	17.2
	1/4	KQB2L06-G02	19		17.8		23.4	22.6			34.6
	3/8	KQB2L06-G03	22		21.8		25.9	24.1			54.5
$\phi 8$	1/8	KQB2L08-G01	14	13.7	13.8	18.6	21.3	22.6	16.1	21.6	20.2
	1/4	KQB2L08-G02	19		17.8		24.7	25			36
	3/8	KQB2L08-G03	22		21.8		27.2	26.5			55.6
$\phi 10$	1/8	KQB2L10-G01	14	16.6	13.8	20	22.7	25.5	17	21.6	25.7
	1/4	KQB2L10-G02	19		17.8		26.1	27.9			38.2
	3/8	KQB2L10-G03	22		21.8		28.6	29.4		56.2	
	1/2	KQB2L10-G04	27		26.5		32.6	31.9		97.9	
$\phi 12$	1/4	KQB2L12-G02	19	18.7	17.8	22.6	27.2	30	18.6	50.2	41.9
	3/8	KQB2L12-G03	22		21.8		29.6	31.4			54.3
	1/2	KQB2L12-G04	27		26.5		33.6	33.9			94.6
$\phi 16$	3/8	KQB2L16-G03	22	24.6	21.8	26.3	32.4	36.5	20.8	71	64.7
	1/2	KQB2L16-G04	27		26.5		27.3	36.4			39

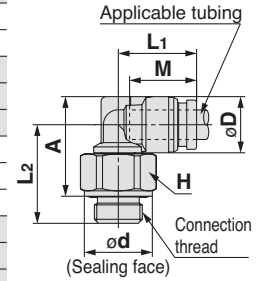

Note 1) For the $\phi 16$, this dimension refers to the O.D. of the release button.

Note 2) Value of FEP tubing.

Value of nylon tubing for $\phi 16$ only.

Male Branch Tee: KQB2T

Applicable tubing O.D. (mm)	Connection thread G	Model	H (Width across flat)	Note 1) ϕD	ϕd	L1	L2	A	M	Note 2) Effective area (mm ²)	Weight (g)
$\phi 4$	1/8	KQB2T04-G01	14	9.1	13.8	14.4	18.9	17.9	12.6	6	17.5
	1/4	KQB2T04-G02	19		17.8		22.3	20.3			34.9
$\phi 6$	1/8	KQB2T06-G01	14	11.4	13.8	15.9	20	20.2	13.6	13.9	21
	1/4	KQB2T06-G02	19		17.8		23.4	22.6			38
	3/8	KQB2T06-G03	22		21.8		25.9	24.1			57.9
$\phi 8$	1/8	KQB2T08-G01	14	13.7	13.8	18.6	21.3	22.6	16.1	26.3	25.6
	1/4	KQB2T08-G02	19		17.8		24.7	25			41.2
	3/8	KQB2T08-G03	22		21.8		27.2	26.5			60.8
$\phi 10$	1/8	KQB2T10-G01	14	16.6	13.8	20	22.7	25.5	17	40.8	34
	1/4	KQB2T10-G02	19		17.8		26.1	27.9			46
	3/8	KQB2T10-G03	22		21.8		28.6	29.4		64	
	1/2	KQB2T10-G04	27		26.5		32.6	31.9		105.8	
$\phi 12$	1/4	KQB2T12-G02	19	18.7	17.8	22.6	27.2	30	18.6	57.2	53
	3/8	KQB2T12-G03	22		21.8		29.6	31.4			54.3
	1/2	KQB2T12-G04	27		26.5		33.6	33.9			105
$\phi 16$	3/8	KQB2T16-G03	22	24.6	21.8	26.3	32.4	36.5	20.8	71	82.2
	1/2	KQB2T16-G04	27		26.5		27.3	36.4			39

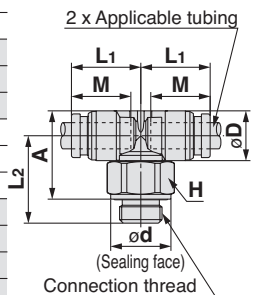

Note 1) For the $\phi 16$, this dimension refers to the O.D. of the release button.

Note 2) Value of FEP tubing.

Value of nylon tubing for $\phi 16$ only.

KQB2 Series

Applicable Tubing: Metric Size, Connection Thread: G

Tubing One-touch fittings
Plug-in reducer/Plug

Tubing Union tee/Straight union etc.

Refer to page 1 and after for details.

Dimensions

Bulkhead Connector: KQB2E

Applicable tubing O.D. (mm)	Connection thread G	Model	T (M)	Width across flat		L1	L2	Mounting hole	M	Note) Effective area (mm ²)	Weight (g)
				H1	H2						
ø4	1/8	KQB2E04-G01	M10 x 1	17	12	27.1	11	11	12.6	5.6	25.1
	1/4	KQB2E04-G02		19		32.7	16.6				36.9
ø6	1/8	KQB2E06-G01	M14 x 1	17	17	25.5	7.4	15	13.6	13.1	26.8
	1/4	KQB2E06-G02		19		33.5	15.4				42.7
	3/8	KQB2E06-G03		24		35	16.9				62
ø8	1/8	KQB2E08-G01	M15 x 1	17	19	27.6	8.2	16	16.1	26.1	30.4
	1/4	KQB2E08-G02		19		34.5	15.1				43.9
	3/8	KQB2E08-G03		24		36	16.6				66.2
ø10	1/4	KQB2E10-G02	M18 x 1	19	21	33.5	13.5	19	17	41.5	46.8
	3/8	KQB2E10-G03		24		35.6	15.6				65.4
ø12	3/8	KQB2E12-G03	M20 x 1	24	24	35.9	14.7	21	18.6	58.3	119.2
	1/2	KQB2E12-G04		27		42.2	21				91.9
ø16	3/8	KQB2E16-G03	M27 x 1	29	30	37.2	13.1	28	20.8	96	118.2
	1/2	KQB2E16-G04		43.1		19	113				128.7

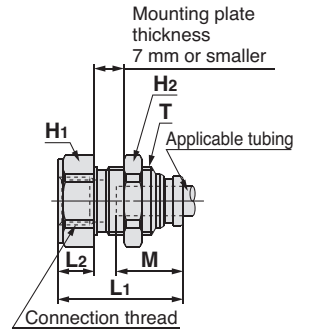
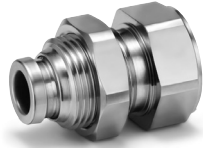

Note) Value of FEP tubing.
Value of nylon tubing for ø16 only.

Extended Male Union: KQB2W

Applicable tubing O.D. (mm)	Connection thread G	Model	H (Width across flat)	Note 1) øD	ød	L1	L2	A	M	Note 2) Effective area (mm ²)	Weight (g)
1/4	KQB2W04-G02	19	17.8	38.7	36.7	70.6					
ø6	1/8	KQB2W06-G01	14	11.4	13.8	15.9	36.4	36.6	13.6	10.9	36.1
	1/4	KQB2W06-G02	19		17.8		39.8	39			72.2
	3/8	KQB2W06-G03	22		21.8		42.3	40.5			106.7
ø8	1/8	KQB2W08-G01	14	13.7	13.8	18.6	40	41.3	16.1	20.5	41.3
	1/4	KQB2W08-G02	19		17.8	43.4	43.7	76.7			
	3/8	KQB2W08-G03	22		21.8	45.9	45.2	112.9			
ø10	1/4	KQB2W10-G02	19	16.6	17.8	21	49.8	51.6	17	33.5	84.8
	3/8	KQB2W10-G03	22		21.8		50.2	51			116.6
	1/2	KQB2W10-G04	27		26.5		54.2	53.5			196.6
ø12	1/4	KQB2W12-G02	19	18.7	17.8	22.6	50.9	53.7	18.6	47.7	88.7
	3/8	KQB2W12-G03	22		21.8	23.6	53.3	55.1			111.6
	1/2	KQB2W12-G04	27		26.5	57.3	57.6	193.8			
ø16	3/8	KQB2W16-G03	22	24.6	21.8	26.3	62	66.1	20.8	71	133.6
	1/2	KQB2W16-G04	27		26.5	27.3	66	68.6			100

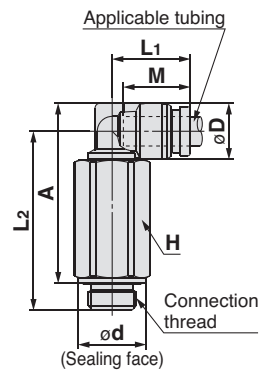

Note 1) For the ø16, this dimension refers to the O.D. of the release button.

Note 2) Value of FEP tubing.
Value of nylon tubing for ø16 only.

Female Connector: KQB2F

Applicable tubing O.D. (mm)	Connection thread G	Model	H (Width across flat)	Note 1) øD	L1	L2	M	Note 2) Effective area (mm ²)	Weight (g)
1/4	KQB2F04-G02	19	30.6	14.5	32				
ø6	1/8	KQB2F06-G01	17	11.1	25.5	9.7	13.6	13.1	22.6
	1/4	KQB2F06-G02	19		31.1	14.7			33
	3/8	KQB2F06-G03	24		32.6	14.6			51.1
ø8	1/8	KQB2F08-G01	17	13.4	27.6	10	16.1	26.1	25.1
	1/4	KQB2F08-G02	19		33.2	14.9			36.3
	3/8	KQB2F08-G03	24		34.6	14.7			53.8
ø10	1/4	KQB2F10-G02	19	16.4	33.5	15.2	17	41.5	39.9
	3/8	KQB2F10-G03	24		34.9	15			57.7
ø12	1/4	KQB2F12-G02	19	18.5	34.5	15.2	18.6	58.3	41.8
	3/8	KQB2F12-G03	24		35.9	15			59.7
	1/2	KQB2F12-G04	27		41.8	19.9			81.6
ø16	3/8	KQB2F16-G03	24	24.6	37.2	15.4	20.8	81	66.6
	1/2	KQB2F16-G04	27		43.1	20.4			89.1

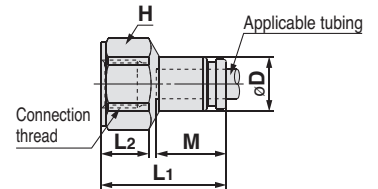
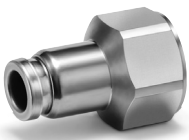

Note 1) For the ø10, ø12, and ø16, this dimension refers to the O.D. of the release button.

Note 2) Value of FEP tubing.
Value of nylon tubing for ø16 only.

Related Equipment

Spatter cover

(Applicable tubing: FR soft nylon, FR double layer, FR three-layer)

Applicable tubing O.D. (mm)	Model
ø6	KQB2-06C-X1124
ø8	KQB2-08C-X1124
ø10	KQB2-10C-X1124

* Since the spatter cover is designed for multi-layer (double layer, three-layer) tubing, sufficient effects cannot be obtained in foreign matter flow-in or followability for singlelayer tubing.

* The cover can be attached regardless of the single-layer/multi-layer tubing.

* Cannot be used for union "Y" (KQB2U) 2-port side.





Series KQB2

Specific Product Precautions

Be sure to read before handling. Refer to back cover for Safety Instructions, "Handling Precautions for SMC Products" (M-E03-3) for Fittings and Tubing Precautions.

Selection

Caution

1. The surge pressure must be under the maximum operating pressure. If the surge pressure exceeds the maximum operating pressure, it will result in damage to fittings and tubes or the tube may result in being fallen out.
2. If using a fluoro resin tube in an environment where the fluid temperature changes drastically, it is recommended to use an inner sleeve. Otherwise, air leakage may occur or the tube may release from fitting due to deformation of the tube.
3. The particle generation of the KQB2 series depends on the operating conditions and operating environment. If you are concerned about the effects on machinery and equipment, check the particle generation with your machine before use.

The components of the KQB2 series may slide due to changes in the internal pressure, which may generate particles. When using male elbow, male branch tee, and extended male elbow fittings, particles may be generated by rotation for positioning after connecting.

Mounting

Caution

1. The union elbow, union tee, union "Y", different diameter tee, and different diameter union "Y" fittings should be fixed through the mounting hole. Otherwise, air leakage or breaking can occur due to a pulling force or moment load created by the product's weight.
2. The male elbow, male branch tee, and extended male elbow fittings can be rotated for positioning, but they cannot be used rotating. This will cause metal debris by wearing, which may enter the operating fluid or cause fitting damage.
3. Keep the connection part of fittings and tubes from rotating or oscillating movement.

Installation and Removal of Tube

Caution

1. Installation of tube

- 1) Grease is not used for the KQB2 series, therefore a greater insertion force is required when the tube is installed. In particular, polyurethane tube may fold when inserted due to its softness. Hold the end of the tube, and insert it all the way in slowly and securely. Refer to dimension "M" in the dimension drawings for guidance on the insertion depth of tube.

2. Removal of tube

- 1) For tube used at a high temperature or for an extended period of time, there is a possibility that it will not fit into a one-touch fitting again due to an enlarged O.D. Dispose of the tube and replace it with a new one.

G Thread Fittings



Caution

1. The standard thread torques of the fittings are as shown in the below table.

Connection thread size	Proper tightening torque N·m
G1/8	2.9 to 3.2
G1/4	5.7 to 6.3
G3/8	9.5 to 10.5
G1/2	14.3 to 15.8

Safety Instructions

These safety instructions are intended to prevent hazardous situations and/or equipment damage. These instructions indicate the level of potential hazard with the labels of “Caution,” “Warning” or “Danger.” They are all important notes for safety and must be followed in addition to International Standards (ISO/IEC) ¹⁾, and other safety regulations.

-  **Caution:** **Caution** indicates a hazard with a low level of risk which, if not avoided, could result in minor or moderate injury.
-  **Warning:** **Warning** indicates a hazard with a medium level of risk which, if not avoided, could result in death or serious injury.
-  **Danger:** **Danger** indicates a hazard with a high level of risk which, if not avoided, will result in death or serious injury.

- 1) ISO 4414: Pneumatic fluid power – General rules relating to systems.
ISO 4413: Hydraulic fluid power – General rules relating to systems.
IEC 60204-1: Safety of machinery – Electrical equipment of machines.
(Part 1: General requirements)
- ISO 10218-1: Manipulating industrial robots - Safety.
etc.

Warning

1. The compatibility of the product is the responsibility of the person who designs the equipment or decides its specifications.

Since the product specified here is used under various operating conditions, its compatibility with specific equipment must be decided by the person who designs the equipment or decides its specifications based on necessary analysis and test results. The expected performance and safety assurance of the equipment will be the responsibility of the person who has determined its compatibility with the product. This person should also continuously review all specifications of the product referring to its latest catalogue information, with a view to giving due consideration to any possibility of equipment failure when configuring the equipment.

2. Only personnel with appropriate training should operate machinery and equipment.

The product specified here may become unsafe if handled incorrectly. The assembly, operation and maintenance of machines or equipment including our products must be performed by an operator who is appropriately trained and experienced.

3. Do not service or attempt to remove product and machinery/equipment until safety is confirmed.

1. The inspection and maintenance of machinery/equipment should only be performed after measures to prevent falling or runaway of the driven objects have been confirmed.
2. When the product is to be removed, confirm that the safety measures as mentioned above are implemented and the power from any appropriate source is cut, and read and understand the specific product precautions of all relevant products carefully.
3. Before machinery/equipment is restarted, take measures to prevent unexpected operation and malfunction.

4. Contact SMC beforehand and take special consideration of safety measures if the product is to be used in any of the following conditions.

1. Conditions and environments outside of the given specifications, or use outdoors or in a place exposed to direct sunlight.
2. Installation on equipment in conjunction with atomic energy, railways, air navigation, space, shipping, vehicles, military, medical treatment, combustion and recreation, or equipment in contact with food and beverages, emergency stop circuits, clutch and brake circuits in press applications, safety equipment or other applications unsuitable for the standard specifications described in the product catalogue.
3. An application which could have negative effects on people, property, or animals requiring special safety analysis.
4. Use in an interlock circuit, which requires the provision of double interlock for possible failure by using a mechanical protective function, and periodical checks to confirm proper operation.

Caution

1. The product is provided for use in manufacturing industries.

The product herein described is basically provided for peaceful use in manufacturing industries. If considering using the product in other industries, consult SMC beforehand and exchange specifications or a contract if necessary. If anything is unclear, contact your nearest sales branch.

Limited warranty and Disclaimer/Compliance Requirements

The product used is subject to the following “Limited warranty and Disclaimer” and “Compliance Requirements”. Read and accept them before using the product.

Limited warranty and Disclaimer

1. The warranty period of the product is 1 year in service or 1.5 years after the product is delivered, whichever is first. ²⁾ Also, the product may have specified durability, running distance or replacement parts. Please consult your nearest sales branch.
2. For any failure or damage reported within the warranty period which is clearly our responsibility, a replacement product or necessary parts will be provided. This limited warranty applies only to our product independently, and not to any other damage incurred due to the failure of the product.
3. Prior to using SMC products, please read and understand the warranty terms and disclaimers noted in the specified catalogue for the particular products.
- 2) Vacuum pads are excluded from this 1 year warranty. A vacuum pad is a consumable part, so it is warranted for a year after it is delivered. Also, even within the warranty period, the wear of a product due to the use of the vacuum pad or failure due to the deterioration of rubber material are not covered by the limited warranty.

Compliance Requirements

1. The use of SMC products with production equipment for the manufacture of weapons of mass destruction (WMD) or any other weapon is strictly prohibited.
2. The exports of SMC products or technology from one country to another are governed by the relevant security laws and regulations of the countries involved in the transaction. Prior to the shipment of a SMC product to another country, assure that all local rules governing that export are known and followed.

Caution

SMC products are not intended for use as instruments for legal metrology.

Measurement instruments that SMC manufactures or sells have not been qualified by type approval tests relevant to the metrology (measurement) laws of each country. Therefore, SMC products cannot be used for business or certification ordained by the metrology (measurement) laws of each country.

Safety Instructions

Be sure to read “Handling Precautions for SMC Products” (M-E03-3) before using.

SMC Corporation (Europe)

Austria	+43 (0)2262622800	www.smc.at	office@smc.at
Belgium	+32 (0)33551464	www.smc.be	info@smc.be
Bulgaria	+359 (0)2807670	www.smc.bg	office@smc.bg
Croatia	+385 (0)13707288	www.smc.hr	office@smc.hr
Czech Republic	+420 541424611	www.smc.cz	office@smc.cz
Denmark	+45 70252900	www.smc.dk.com	smc@smcdk.com
Estonia	+372 651 0370	www.smcee.ee	info@smcee.ee
Finland	+358 207513513	www.smc.fi	smcfl@smc.fi
France	+33 (0)164761000	www.smc-france.fr	supportclient@smc-france.fr
Germany	+49 (0)61034020	www.smc.de	info@smc.de
Greece	+30 210 2717265	www.smchellas.gr	sales@smchellas.gr
Hungary	+36 23513000	www.smc.hu	office@smc.hu
Ireland	+353 (0)14039000	www.smcautomation.ie	sales@smcautomation.ie
Italy	+39 03990691	www.smcitalia.it	mailbox@smcitalia.it
Latvia	+371 67817700	www.smc.lv	info@smc.lv

Lithuania	+370 5 2308118	www.smclt.lt	info@smclt.lt
Netherlands	+31 (0)205318888	www.smc.nl	info@smc.nl
Norway	+47 67129020	www.smc-norge.no	post@smc-norge.no
Poland	+48 222119600	www.smc.pl	office@smc.pl
Portugal	+351 214724500	www.smc.eu	apoioclientept@smc.smces.es
Romania	+40 213205111	www.smcromania.ro	smcromania@smcromania.ro
Russia	+7 (812)3036600	www.smc.eu	sales@smcru.com
Slovakia	+421 (0)413213212	www.smc.sk	office@smc.sk
Slovenia	+386 (0)73885412	www.smc.si	office@smc.si
Spain	+34 945184100	www.smc.eu	post@smc.smces.es
Sweden	+46 (0)86031240	www.smc.nu	smc@smc.nu
Switzerland	+41 (0)523963131	www.smc.ch	info@smc.ch
Turkey	+90 212 489 0 440	www.smcturkey.com.tr	satis@smcturkey.com.tr
UK	+44 (0)845 121 5122	www.smc.uk	sales@smc.uk

South Africa +27 10 900 1233 www.smcza.co.za zasales@smcza.co.za